

**IL FANALE®**







# **IL FANALE<sup>®</sup>**

2017





# **IL FANALE®**

DAL 1979

LA STORIA DE IL FANALE RISALE AL 1979, QUANDO FAUSTO DALLA TORRE E SUA MOGLIE LUISA MARTIN, DECIDONO DI INTRAPRENDERE UNO STRAORDINARIO PERCORSO FATTO DI PASSIONE E DURO LAVORO. PARTENDO DALLA LORO DECENNALE ESPERIENZA NELLA LAVORAZIONE DEI METALLI TRADIZIONALI, FONDANO L'AZIENDA CON L'INTENZIONE E LA VOLONTÀ DI PRODURRE LAMPADE ORIGINALI E UNICHE DI ALTISSIMA QUALITÀ.

DEDIZIONE, DETERMINAZIONE E IMPEGNO SONO LE QUALITÀ CHE RENDONO IL FANALE QUELLO CHE È OGGI: UN'AZIENDA ARTIGIANA DI SUCCESSO NEL SETTORE DELL'ILLUMINAZIONE, CONOSCIUTA IN ITALIA E ALL'ESTERO.



THE STORY OF IL FANALE DATES BACK TO 1979 WHEN FAUSTO DALLA TORRE AND HIS WIFE LUISA MARTIN, DECIDED TO EMBARK ON AN EXTRAORDINARY JOURNEY OF PASSION AND HARD WORK. STARTING FROM THEIR DECENNIAL EXPERIENCE IN WORKING WITH TRADITIONAL METALS, THEY FOUND THE COMPANY WITH THE INTENTION AND THE WILL TO PRODUCE UNIQUE AND ORIGINAL LAMPS OF THE HIGHEST QUALITY.

DEDICATION, DETERMINATION AND COMMITMENT ARE THE QUALITIES THAT MAKE IL FANALE WHAT IT IS TODAY: A SUCCESSFUL HANDICRAFT COMPANY WORKING IN THE LIGHTING INDUSTRY, KNOWN IN ITALY AND ABROAD.



# INDEX

INDOOR	MOLECOLA	014 - 029
	ÉTOILE	030 - 043
	ASTRO	044 - 051
	ALCHIMIA	052 - 065
	LOFT	066 - 079
	REPORTER	080 - 089
	OFFICINA	090 - 099
	KHONUS	100 - 107
	GIRASOLI	108 - 119
	LONDON	120 - 137
	POGGIO	150 - 157
	CANTINA	158 - 165
	CASCINA	166 - 175
	COUNTRY	176 - 189
	MINI	190 - 197
	FIORI DI PIZZO	198 - 207
	ANITA	208 - 217
TABIÀ	218 - 227	
RILEGATO	409 - 429	
INDOOR / OUTDOOR	GALILEO	138 - 149
	CONTRADA	228 - 235
	BARCHESSA	236 - 247
	DROP	248 - 263
OUTDOOR	LANTERNE	264 - 277
	QUADRO	278 - 285
	DECORI	286 - 295
	BORGO	296 - 305
	CALMAGGIORE	306 - 313
	PATIO	314 - 321
	GRANAIO	322 - 329
	FIORDO	330 - 337
	VENEZIA	338 - 351
	LOGGIA	352 - 359
	GARDEN	360 - 367
	PORTO	368 - 373
	MARINA	374 - 383
	PONTE	384 - 391
SISTEMI / SYSTEMS	SISTEMA CANALINE	392 - 407
	COMPANY	431 - 433
	MANUFACTURING	435 - 438
	PROJECTS	439 - 469
	F.A.Q	471 - 473

# ALPHABETICAL INDEX

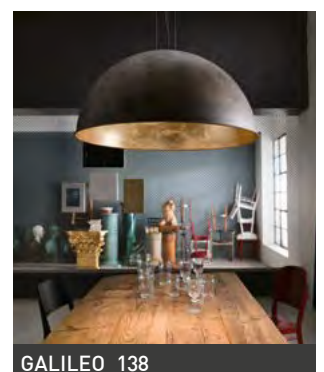
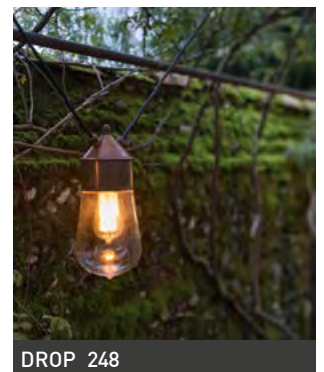
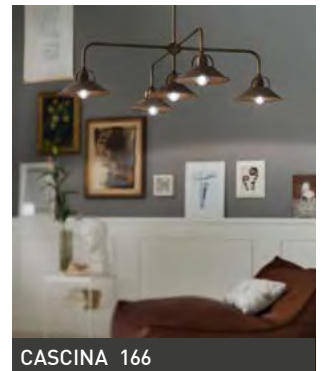
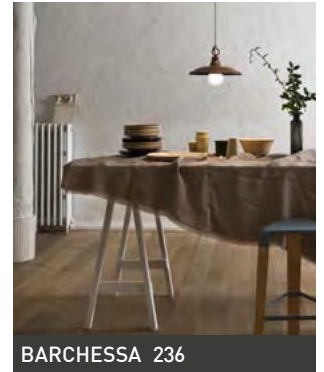
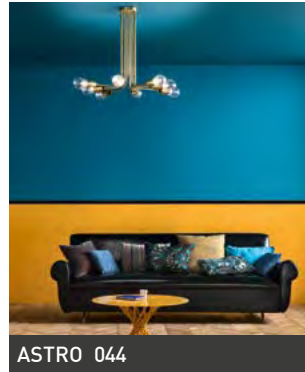
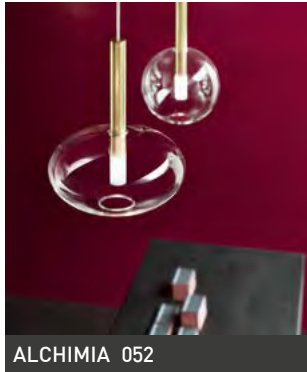



GARDEN 360



GIRASOLI 108



GRANAIO 322

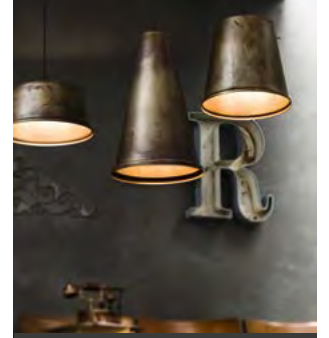

KHONUS 100



LANTERNE 264



LOFT 066



LOGGIA 352



LONDON 120

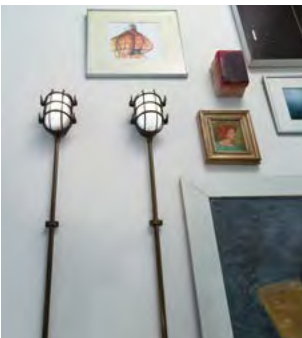

MARINA 374



MINI 190



MOLECOLA 014



OFFICINA 090



PATIO 314



POGGIO 150



PONTE 384



PORTO 368

# ALPHABETICAL INDEX

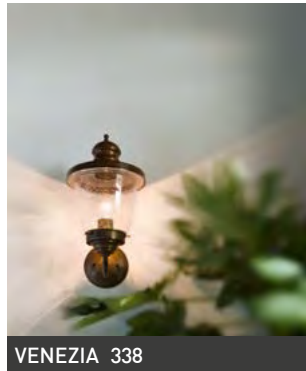
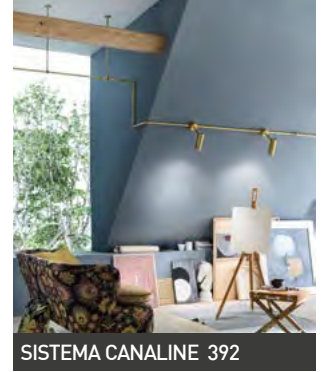

# COMPANY INDEX



COMPANY 431



MANUFACTURING 435



PROJECTS 439

# MOLECOLA

design  
FABRIZIO FAVA







DISPONIBILE NELLE VERSIONI  
IN OTTONE NATURALE O OTTONE  
ANTICATO CON SFERE DI VETRO  
TRASPARENTE E SABBIATO, LA  
COLLEZIONE DI LAMPADE DA  
INTERNO MOLECOLA SI COMPONE  
DI SOSPENSIONI, PIANTANA,  
PLAFONIERE, APPLIQUE E LAMPADA  
DA TAVOLO.

THE MOLECOLA COLLECTION  
OF INDOOR LAMPS COMPRISES  
SUSPENSION LAMPS, A FLOOR LAMP,  
CEILING LAMPS, A WALL LAMP AND  
A TABLE LAMP. THEY ARE AVAILABLE  
IN NATURAL OR ANTIQUE-EFFECT  
BRASS WITH TRANSPARENT AND  
FROSTED SPHERES.





















lampade / lamps

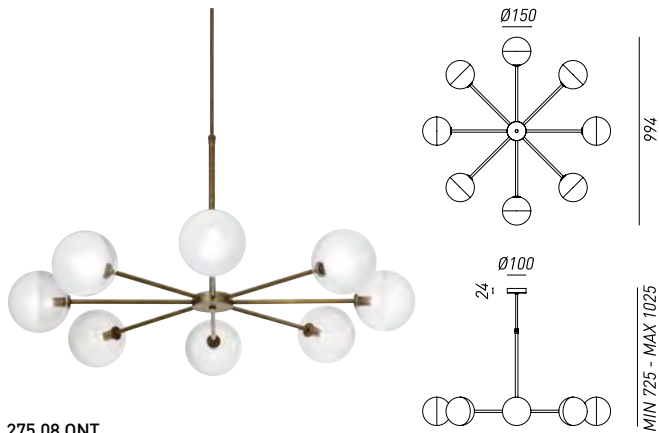

275.08.ONT  
275.08.OOT  
8x Max 25W G9

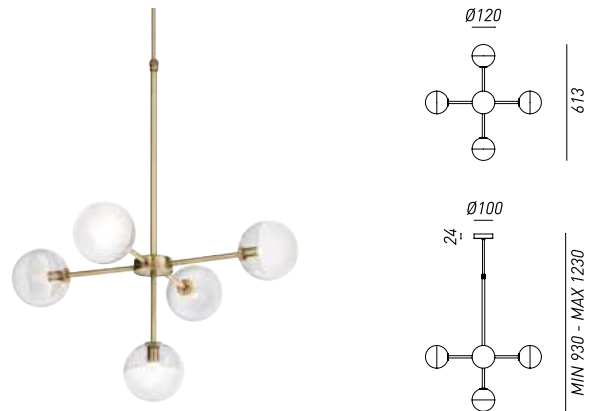

275.09.ONT  
275.09.OOT  
5x Max 25W G9

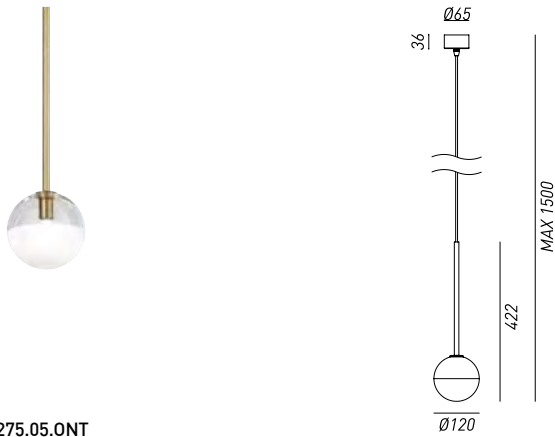

275.05.ONT  
275.05.OOT  
1x Max 25W G9

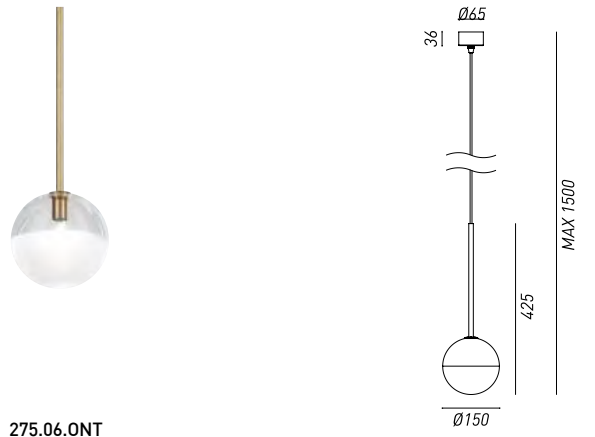

275.06.ONT  
275.06.OOT  
1x Max 25W G9



275.01.ONT  
275.01.OOT  
1x Max 25W G9



275.02.ONT  
275.02.OOT  
1x Max 25W G9

*lampade / lamps*

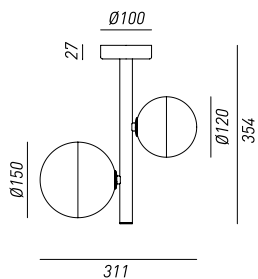

275.04.ONT  
275.04.OOT  
2x Max 25W G9

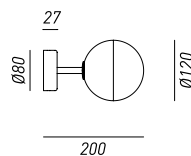

275.03.ONT  
275.03.OOT  
1x Max 25W G9

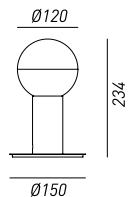

275.10.ONT  
275.10.OOT  
1x Max 25W G9

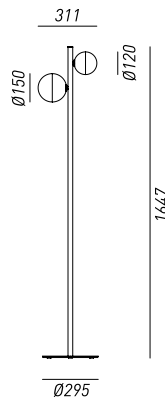

275.11.ONT  
275.11.OOT  
2x Max 25W G9

---

*finiture montatura / frame finishes*



OTTONE  
BRASS



OTTONE NATURALE  
NATURAL BRASS

---

*vetro / glass*



VETRO TRASPARENTE / BIANCO  
TRANSPARENT / WHITE GLASS

---

# ÉTOILE

design  
MIRTA LANDO







ELEGANTE E RAFFINATA COME LA PRIMA BALLERINA DI UN CORPO DI BALLO: COSÌ SI PRESENTA LA COLLEZIONE DI LAMPADE DA INTERNO ÉTOILE. LA COLLEZIONE, DISPONIBILE CON MONTATURA IN OTTONE NATURALE O OTTONE ANTICATO E VETRO BOROSILICATO, È COMPOSTA DA SOSPENSIONI, PIANTANA, LAMPADA DA TAVOLO, PLAFONIERA E APPLIQUE.

THE ÉTOILE COLLECTION OF INDOOR LAMPS IS AS ELEGANT AND SOPHISTICATED AS THE PRINCIPAL DANCER OF A BALLET COMPANY. AVAILABLE WITH STRUCTURE IN NATURAL OR ANTIQUE-EFFECT BRASS AND BOROSILICATE WHITE GLASS, THE COLLECTION COMPRISES SUSPENSION LAMPS, A FLOOR LAMP, A TABLE LAMP, A CEILING LAMP AND WALL LAMPS.



















*lampade / lamps*

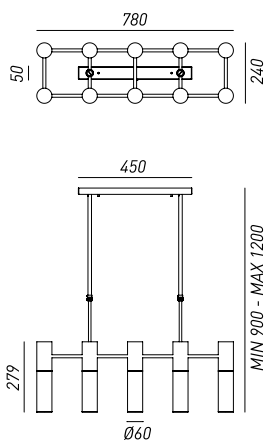

274.10.ONB  
274.10.OOB  
10x Max 25W G9

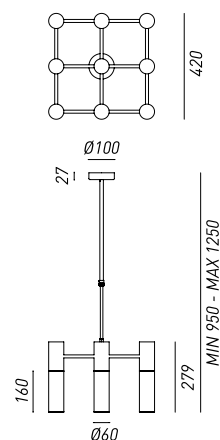

274.09.ONB  
274.09.OOB  
9x Max 25W G9

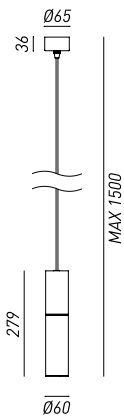

274.07.ONB  
274.07.OOB  
1x Max 25W G9



274.01.ONB  
274.01.OOB  
1x Max 25W G9

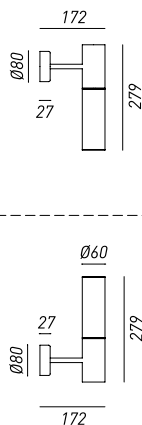

274.03.ONB  
274.03.OOB  
1x Max 25W G9

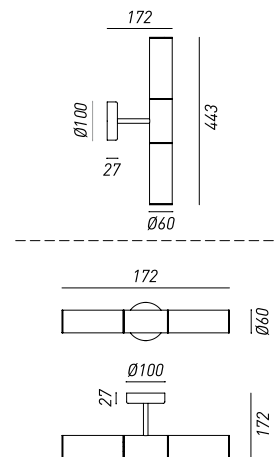

274.04.ONB  
274.04.OOB  
2x Max 25W G9



274.05.0NB  
274.05.0OB  
1x Max 25W G9 

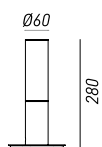

274.06.0NB  
274.06.0OB  
1x Max 25W G9 

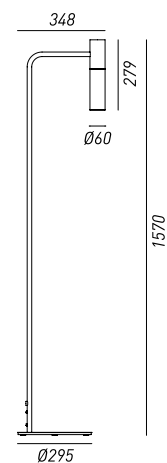

*finiture montatura / frame finishes*



OTTONE  
BRASS



OTTONE NATURALE  
NATURAL BRASS

*vetro / glass*



VETRO BIANCO  
WHITE GLASS

**ASTRO**



LINEE PULITE ED ESSENZIALI DANNO  
RISALTO ALLA PUREZZA DELLA  
MATERIA E CARATTERIZZANO QUESTE  
LAMPADE DA INTERNO REALIZZATE  
IN OTTONE NATURALE E OTTONE  
ANTICATO.

CLEAN ESSENTIAL LINES ENHANCE  
THE PURITY OF THE MATERIAL OF  
THESE INDOOR LAMPS MADE OF  
NATURAL AND ANTIQUE BRASS.









Lampade / lamps

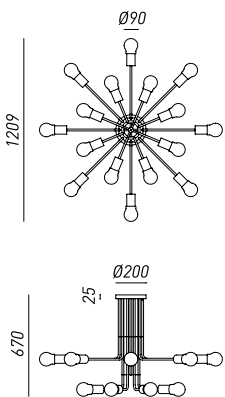

276.10.ONT  
276.10.00T  
16x Max 25W G9

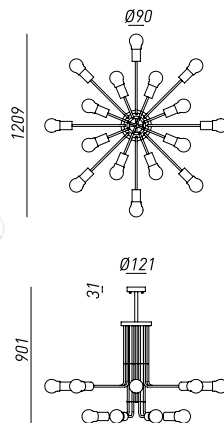

276.13.ONT  
276.13.00T  
16x Max 25W G9

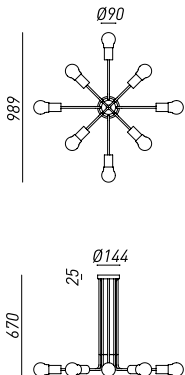

276.09.ONT  
276.09.00T  
8x Max 25W G9

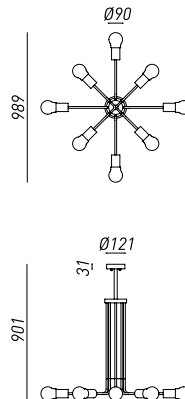

276.12.ONT  
276.12.00T  
8x Max 25W G9

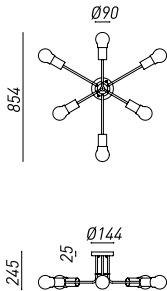

276.11.ONT  
276.11.00T  
6x Max 25W G9

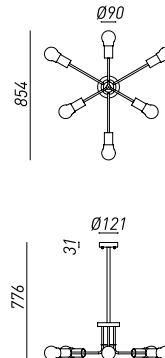

276.14.ONT  
276.14.00T  
6x Max 25W G9

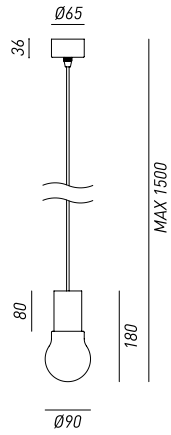

276.05.ONT  
276.05.OOT  
1x Max 25W G9

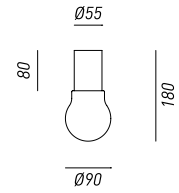

276.01.ONT  
276.01.OOT  
1x Max 25W G9

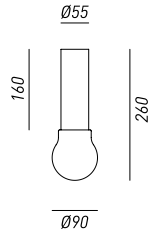

276.02.ONT  
276.02.OOT  
1x Max 25W G9

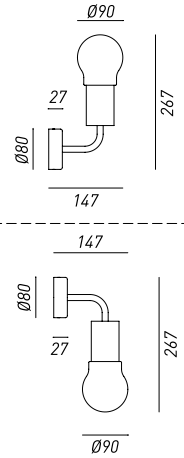

276.03.ONT  
276.03.OOT  
1x Max 25W G9

finiture montatura / frame finishes



OTTONE  
BRASS



OTTONE NATURALE  
NATURAL BRASS

vetro / glass



VETRO TRASPARENTE  
TRANSPARENT GLASS

# ALCHIMIA

design  
BROGLIATOTRAVERSO







UN GIOCO DI PROPORZIONI ED ACCOSTAMENTI, DI DIMENSIONI, DI MATERIALI E DI FORME CHE DANNO VITA A LAMPADE IN OTTONE NATURALE O ANTICATO E VETRO TRASPARENTE, DELICATE E RAFFINATE. UNA FAMIGLIA DI LAMPADE DA COMPORRE PER RENDERE UNICO UN AMBIENTE, GENERANDO UNO SPAZIO NELLO SPAZIO: IL RISULTATO FINALE È APPUNTO UNA QUESTIONE DI ALCHIMIA.

AN INTERPLAY OF PROPORTIONS AND COMBINATIONS, OF DIMENSIONS, MATERIALS AND SHAPES GIVES LIFE TO DELICATE REFINED LAMPS MADE OF NATURAL OR ANTIQUE-EFFECT BRASS AND TRANSPARENT GLASS. A COLLECTION OF LAMPS TO PUT TOGETHER TO MAKE AN ENVIRONMENT UNIQUE, CREATING A SPACE IN SPACE: THE END RESULT IS PRECISELY A MATTER OF ALCHEMY.



**SISTEMA COMPOSTO DA / SYSTEM MADE OF:**

**Codici / Codes:** 1 X 277.12.ON  
1 X 277.13.ON  
1 X 277.14.ON  
1 X 277.15.ON  
1 X 277.16.ON  
6 X 300.42.ON  
1 X 300.41.ON  
1 X 270.38.AA  
1 X 270.37.10













lampade / lamps

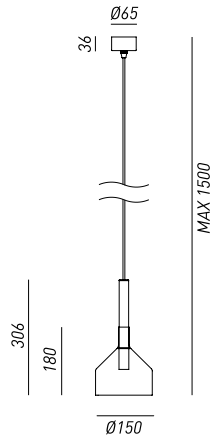

277.02.0NT  
277.02.00T  
1x Max 25W G9

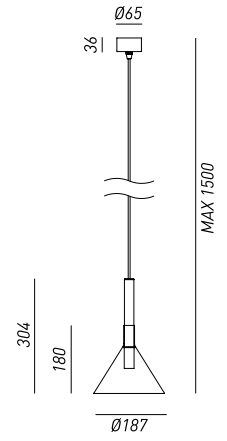

277.03.0NT  
277.03.00T  
1x Max 25W G9

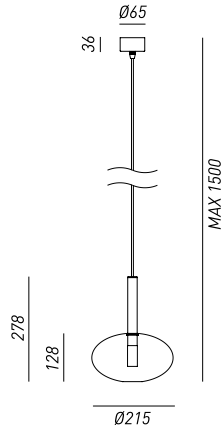

277.04.0NT  
277.04.00T  
1x Max 25W G9

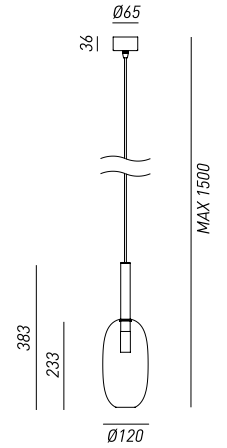

277.05.0NT  
277.05.00T  
1x Max 25W G9

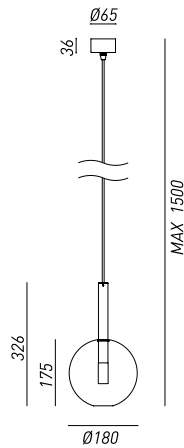

277.06.0NT  
277.06.00T  
1x Max 25W G9

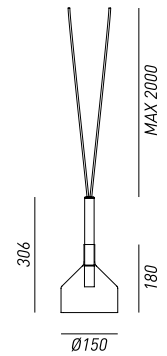

277.12.0NT  
277.12.00T  
1x Max 25W G9

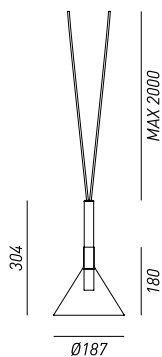

277.13.ONT  
277.13.00T  
1x Max 25W G9

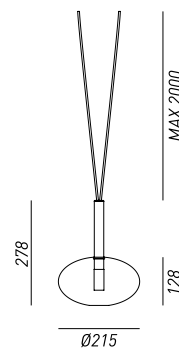

277.14.ONT  
277.14.00T  
1x Max 25W G9

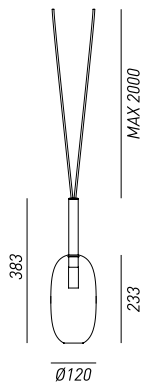

277.15.ONT  
277.15.00T  
1x Max 25W G9

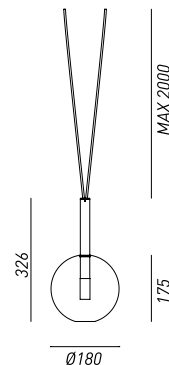

277.16.ONT  
277.16.00T  
1x Max 25W G9

accessori / accessories

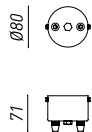

300.41.ON  
300.41.00  
*Rosone per soffitto o parete,  
compreso di 2 tappi e 2 stringicavi.  
Wall or ceiling canopy  
with 2 screw tops and 2 cableglands.*



300.42.ON  
300.42.00  
*Rosone per cavo d'acciaio,  
compreso di 2 tappi e 2 stringicavi.  
Canopy for steel cable  
with 2 screw tops and 2 cableglands.*

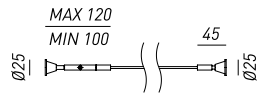

**270.08.AA**  
Kit per cavo d'acciaio Ø 3 mm.  
Kit for steel cable Ø 3 mm.

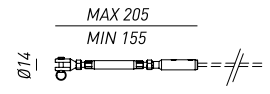

**270.38.AA**  
Kit per cavo d'acciaio, Ø 4 mm  
Kit for steel cable, Ø 4 mm

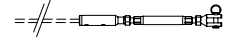

**270.07.05**  
Cavo d'acciaio Ø 3 mm, 5 m.  
Steel cable Ø 3 mm, 5 m.

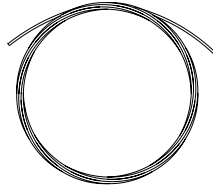

**270.37.10**  
Cavo d'acciaio Ø 4 mm, 10 m  
Steel cable Ø 4 mm, 10 m

**270.37.20**  
Cavo d'acciaio Ø 4 mm, 20 m  
Steel cable Ø 4 mm, 20 m

**270.37.30**  
Cavo d'acciaio Ø 4 mm, 30 m  
Steel cable Ø 4 mm, 30 m

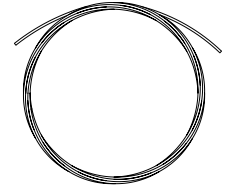

finiture montatura / frame finishes



**OTTONE**  
BRASS



**OTTONE NATURALE**  
NATURAL BRASS

vetro / glass



**VETRO TRASPARENTE**  
TRANSPARENT GLASS

**LOFT**





LA FORTE MATERICITÀ E LE RICERCATE CARATTERISTICHE ESTETICHE CONTRADDISTINGUONO QUESTE LAMPADE DA INTERNO REALIZZATE IN FERRO, ELEMENTI D'ARREDO DAL DISEGNO CONTEMPORANEO. IL PECULIARE SISTEMA A SNODI VOLUTAMENTE INDUSTRIALI, RISULTATO DELLA PERFETTA UNIONE TRA MATERIA E ARTIGIANALITÀ, CONSENTE IL MOVIMENTO DALL'ALTO AL BASSO. LA GRIGLIA, DISPONIBILE COME ACCESSORIO, ACCOMPAGNA LA LINEA ACCENTUANDO COSÌ IL RICHIAMO AL MONDO INDUSTRIALE. LA COLLEZIONE LOFT È COMPOSTA DA SOSPENSIONI, APPLIQUE, UNA LAMPADA DA TAVOLO E UNA PIANTANA, TUTTE NELLA FINITURA FERRO CON SNODI IN FUSIONE DI OTTONE.

WITH THEIR CONTEMPORARY STYLE, THESE IRON INDOOR LAMPS ARE CHARACTERIZED BY STRONG MATERIALS AND REFINED AESTHETIC FEATURES. THANKS TO THE MATERIALS USED AND OUR EXPERTISE IN HANDICRAFT, THE PECULIAR SYSTEM OF INDUSTRIAL JOINTS ALLOWS FOR THE MOVEMENT FROM TOP TO BOTTOM. THE GRID, AVAILABLE AS AN ACCESSORY, GIVES THE LAMP A MORE INDUSTRIAL FEEL. THE LOFT COLLECTION INCLUDES SUSPENSIONS, WALL MOUNTS, TABLE LAMPS AND FLOOR LAMPS, AVAILABLE IN IRON FINISH WITH BRASS JOINTS.

















Lampade / lamps

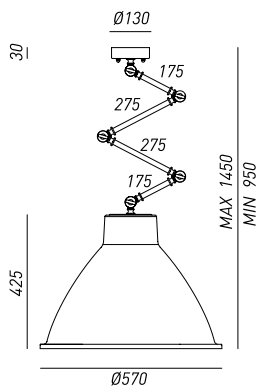

269.04.OF  
1x Max 77W E27

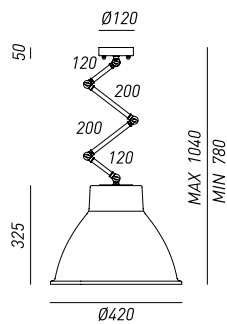

269.03.OF  
1x Max 77W E27

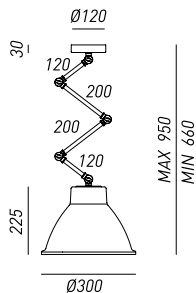

269.02.OF  
1x Max 46W E27

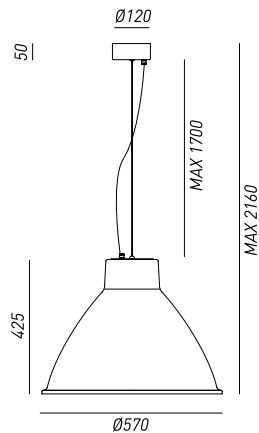

269.14.FF  
1x Max 77W E27

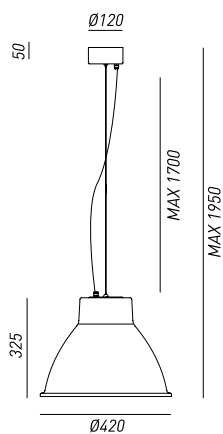

269.13.FF  
1x Max 77W E27

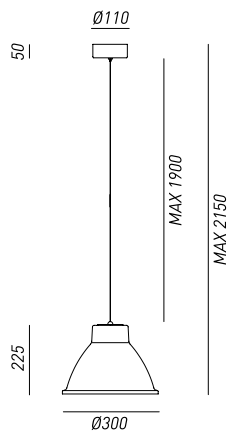

269.12.FF  
1x Max 46W E27

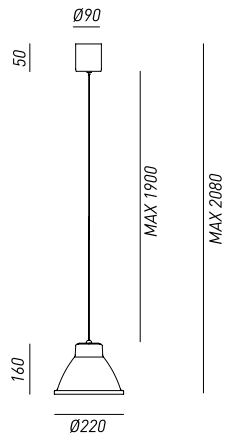

269.11.FF  
1x Max 46W E27

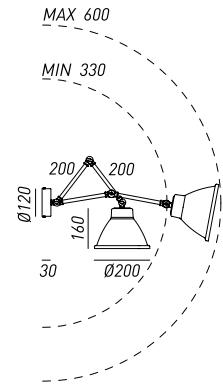

269.05.OF  
1x Max 46W E27

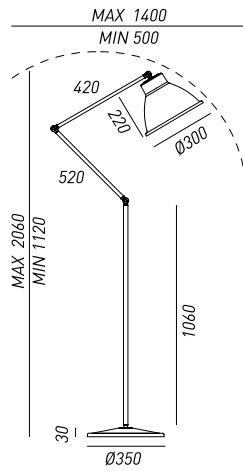

269.08.OF  
1x Max 46W E27

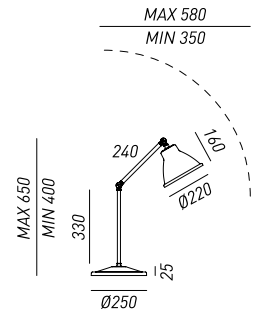

269.06.OF  
1x Max 46W E27

dettaglio rosone / canopie's details



269.04  
 $\varnothing 130$  mm



269.02-03  
 $\varnothing 120$  mm

dettaglio rosoni / canopie's details



269.11-12-13-14  
 Ø 90-110-120 mm

Istruzioni per l'installazione / Installation instructions

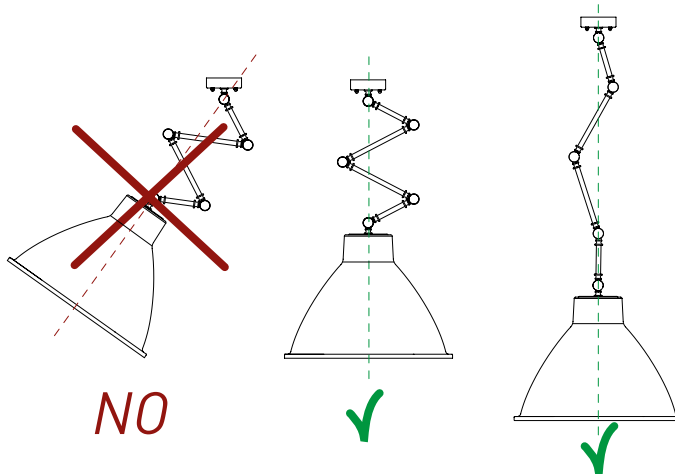

optional

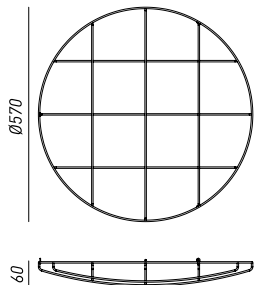
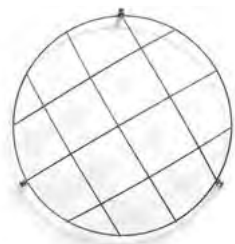

269.54.FF  
 per articoli / for items  
 269.04-14

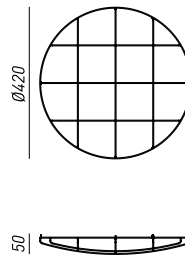
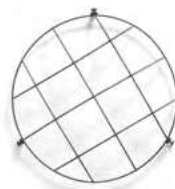

269.53.FF  
 per articoli / for items  
 269.03-13

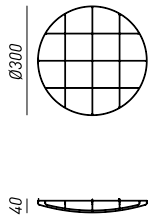

269.52.FF  
 per articoli / for items  
 269.02-08-12

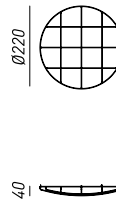

269.51.FF  
 per articoli / for items  
 269.05-06-11



---

*finiture montatura / frame finishes*



OTTONE  
BRASS

---

*finiture testa / shade finishes*



FERRO  
IRON

---

# REPORTER



REPORTER È UNA COLLEZIONE DI LAMPADE DA INTERNO DAL FORTE IMPATTO ESTETICO. OGGETTI CAPACI DI CARATTERIZZARE GLI AMBIENTI CON PARTICOLARI CAMBI DI PROSPETTIVA GRAZIE ALLA LORO DUTTILITÀ, E DI CREARE DISEGNI DI LUCE PERSONALIZZABILI. IL MOVIMENTO MECCANICO DELLA MONTATURA E DELLE SINGOLE TESTE PERMETTE DI INDIRIZZARE LA LUCE IN BASE ALLE PROPRIE ESIGENZE, FACENDO DI REPORTER UNA LAMPADA SIMBOLO DI FUNZIONALITÀ, E ALLO STESSO TEMPO DI ESTETICA E CONTEMPORANEITÀ. ELEMENTI CLASSICI E RIFERIMENTI INDUSTRIALI SI INCONTRANO IN UNA COLLEZIONE COMPOSTA DA SOSPENSIONI, APPLIQUE, UNA LAMPADA DA TAVOLO E UNA PIANTANA, DISPONIBILI NELLA FINITURA FERRO CON SNODI IN FUSIONE DI OTTONE.

THE REPORTER INDOOR LAMP COLLECTION OFFERS A STRONG AESTHETIC IMPACT. THESE LAMPS CAN CREATE DIFFERENT PERSPECTIVES THANKS TO THEIR FLEXIBILITY AND CAN CREATE CUSTOMIZABLE PATTERNS OF LIGHT. THE MECHANICAL MOVEMENT OF THE FRAME AND THE INDIVIDUAL LIGHTS ALLOW FOR THE FOCUSING OF THE LIGHTS TO MATCH YOUR NEEDS. THIS MAKES REPORTER A SYMBOL OF FUNCTIONALITY AND, AT THE SAME TIME, AESTHETICS AND MODERNITY. CLASSICAL ELEMENTS AND INDUSTRIAL REFERENCES MEET IN THIS COLLECTION OF SUSPENSIONS, WALL MOUNTS, TABLE LAMPS AND FLOOR LAMPS. THEY ARE AVAILABLE IN IRON FINISHES WITH BRASS JOINTS.













Lampade / lamps

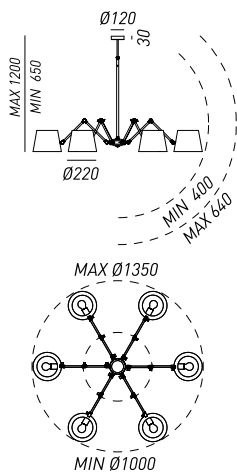

271.04.OF  
6x Max 46W E27

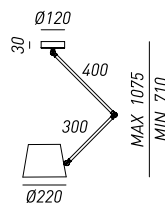

271.01.OF  
1x Max 46W E27

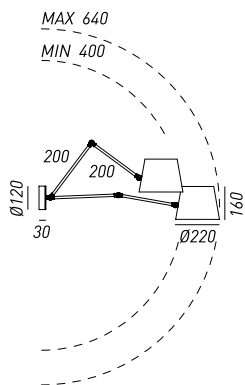

271.05.OF  
1x Max 46W E27

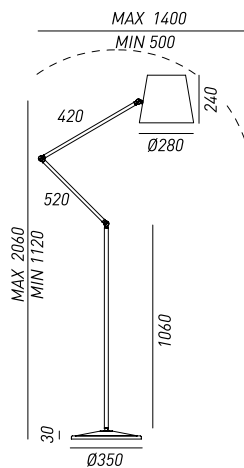

271.08.OF  
1x Max 77W E27

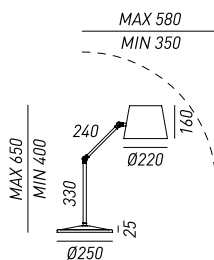

271.06.OF  
1x Max 46W E27

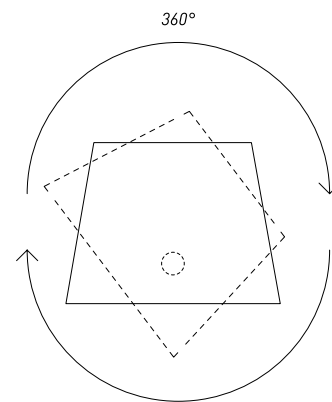

Rotazione della campana: 360°  
Shade rotation: 360°

*dettaglio rosoni / canopie's details*



271.01-04  
Ø 120 mm

*finiture montatura / frame finishes*



OTTONE  
BRASS

*finiture testa / shade finishes*



FERRO  
IRON

**OFFICINA**



ASPETTO RUVIDO E GREZZO  
MA DI GRAN RICERCATEZZA:  
QUESTE LE CARATTERISTICHE DI  
OFFICINA, COLLEZIONE DAL GUSTO  
TIPICAMENTE INDUSTRIAL IN GRADO  
DI CREARE ATMOSFERE RAFFINATE  
NEGLI AMBIENTI IN CUI SI COLLOCA.  
PRODOTTE IN FERRO, QUESTE  
LAMPADE RAPPRESENTANO UN  
OMAGGIO AD UNO STILE MINIMAL ED  
ESSENZIALE.

ROUGH AND RAW LOOK WITH GREAT  
SOPHISTICATION: THESE ARE THE  
CHARACTERISTICS OF OFFICINA,  
COLLECTION OF A TYPICALLY  
INDUSTRIAL TASTE ABLE TO CREATE  
A SOPHISTICATED ATMOSPHERE IN  
THE ENVIRONMENTS IN WHICH IT IS  
PLACED. PRODUCED IN IRON, THESE  
LAMPS ARE A TRIBUTE TO A MINIMAL  
AND ESSENTIAL STYLE.















NEW YORK TIMES SQUARE  
Rockefeller  
Greenwich Village  
CENTRAL PARK  
7<sup>TH</sup> AVENUE  
BROADWAY  
BROOKLYN BRIDGE  
PARK AVE ROOSEVELT BRYANT PARK  
Columbus Circle  
Union Square SOHO

*lampade / lamps*

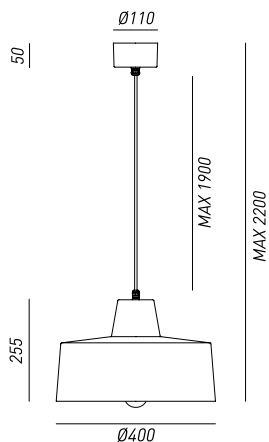

268.06.FF  
1x Max 77W E27

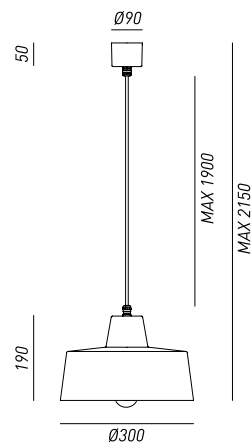

268.05.FF  
1x Max 46W E27

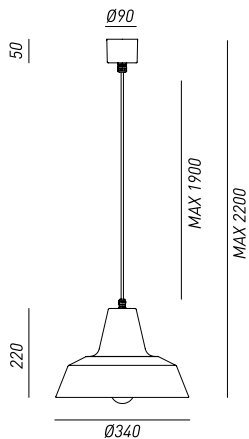

268.10.FF  
1x Max 77W E27

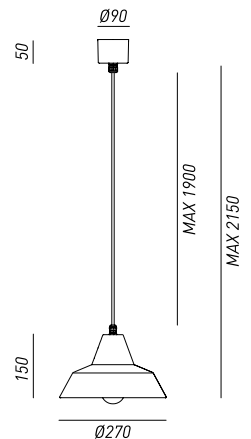

268.09.FF  
1x Max 46W E27

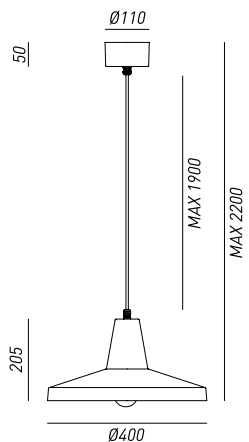

268.02.FF  
1x Max 77W E27

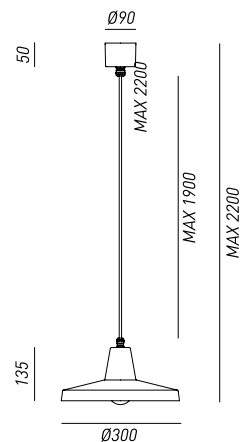
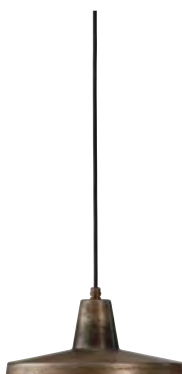

268.01.FF  
1x Max 46W E27

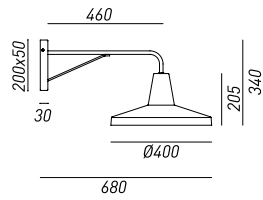

268.04.FF  
1x Max 77W E27 

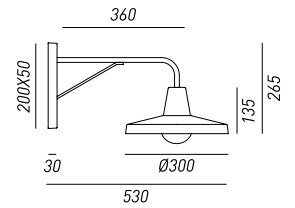

268.03.FF  
1x Max 46W E27 

*dettaglio rosoni / canopie's details*



268.02-06  
Ø 110 mm



268.01-05-09-10  
Ø 90 mm

*finiture montatura / frame finishes*



FERRO  
IRON

*finiture testa / shade finishes*



FERRO  
IRON

**KHONUS**



FORME SEMPLICI E LINEARI  
ISPIRANO UN DESIGN FUNZIONALE.  
COSÌ NASCE KHONUS: UNA SERIE  
DI LAMPADIE CONICHE REALIZZATE  
IN FERRO ANTICATO, IN GRADO DI  
RIFLETTERE LA LUCE SIA VERSO  
IL BASSO CHE VERSO L'ALTO  
ILLUMINANDO INTERAMENTE  
L'AMBIENTE. DISPONIBILI IN TRE  
MISURE DIVERSE, POSSONO ESSERE  
DISPOSTE SINGOLARMENTE OPPURE  
INSIEME VALORIZZANDO LA LORO  
ESSENZA.

SIMPLE AND LINEAR SHAPES  
INSPIRE A FUNCTIONAL DESIGN.  
THIS IS KHONUS: A SERIES OF CONE  
SHAPED LAMPS MADE OF ANTIQUE  
IRON, CAPABLE OF REFLECTING  
LIGHT BOTH DOWNWARDS AND  
UPWARDS ENTIRELY ILLUMINATING  
THE SURROUNDINGS. AVAILABLE  
IN THREE DIFFERENT SIZES, CAN  
BE ARRANGED INDIVIDUALLY OR  
TOGETHER ENHANCING THEIR  
ESSENCE.









*lampade / lamps*

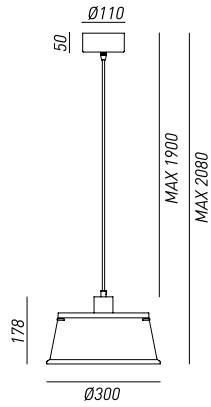

256.01.FF  
1x Max 77W E27

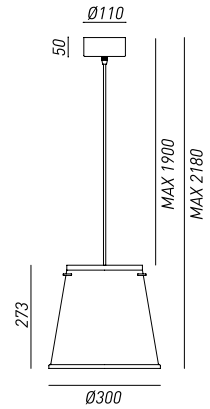

256.02.FF  
1x Max 77W E27

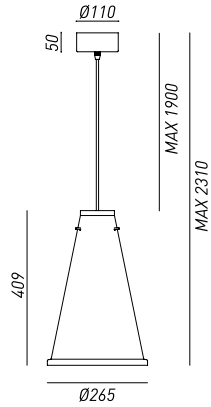

256.03.FF  
1x Max 77W E27

*dettaglio rosone / canopie's details*



256.01-02-03  
Ø 110 mm

---

*finiture montatura / frame finishes*



FERRO  
IRON

---

*finiture testa / shade finishes*



FERRO  
IRON

---

**GIRASOLI**



DESIGN MINIMALISTA ISPIRATO A  
FORME GEOMETRICHE SEMPLICI  
PER UNA COLLEZIONE DALLA  
CONFORMAZIONE CILINDRICA,  
RIGOROSA E PRIMORDIALE.  
REALIZZATE IN OTTONE O FERRO,  
QUESTE LAMPADE DAL GRANDE  
FASCINO SONO CARATTERIZZATE  
DA LINEE PULITE ED ESSENZIALI  
CHE RISALTANO LA PUREZZA DELLA  
MATERIA, PROTAGONISTA ASSOLUTA  
DELLA SERIE GIRASOLI.

MINIMALIST DESIGN INSPIRED BY  
SIMPLE GEOMETRIC SHAPES FOR  
A COLLECTION OF CYLINDRICAL,  
RIGOROUS AND PRIMORDIAL SHAPES.  
MADE OF BRASS OR IRON, THESE  
GLAMOROUS LAMPS HAVE CLEAN  
AND SIMPLE LINES THAT HIGHLIGHT  
THE PURITY OF THE MATERIAL, AN  
ABSOLUTE PROTAGONIST OF THE  
GIRASOLI SERIES.

















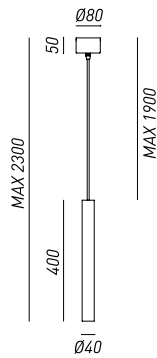

lampade / lamps

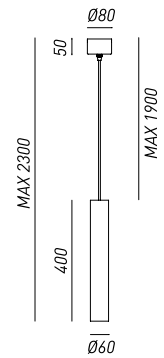

208.31.ON  
208.31.OO  
208.31.FF  
1x Max 25W G9 



208.33.N1  
208.33.O1  
208.33.F1  
1x Max 50W GU10 

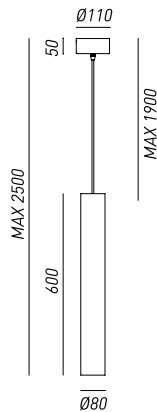

208.34.ON  
208.34.OO  
208.34.FF  
1x Max 50W E27 PAR20 

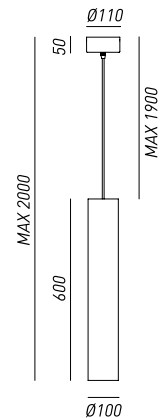

208.35.ON  
208.35.OO  
208.35.FF  
1x Max 75W E27 PAR30   
\*lampada Ø Max 96 mm  
bulb Ø Max 96 mm

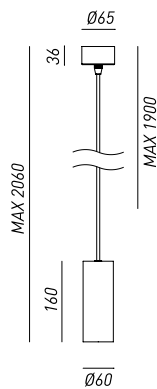

214.21.ON  
214.21.FF  
214.21.OO  
1x Max 35W GU10 

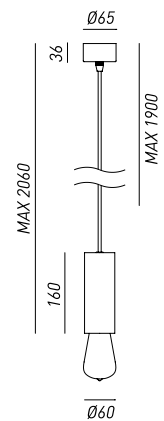

214.20.ON  
214.20.FF  
214.20.OO  
1x Max 57W E27 

*lampade / lamps*

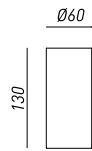

208.03.01  
208.03.F1  
208.03.N1  
1x Max 35W GU10

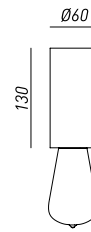

208.03.02  
208.03.F2  
208.03.N2  
1x Max 57W E27

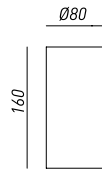

208.02.00  
208.02.FF  
208.02.FN  
1x Max 50W E27 PAR20

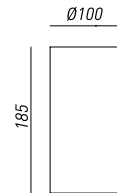

208.01.00  
208.01.FF  
208.01.ON  
1x Max 75W E27PAR30   
\*lampada Ø Max 96 mm  
bulb Ø Max 96 mm

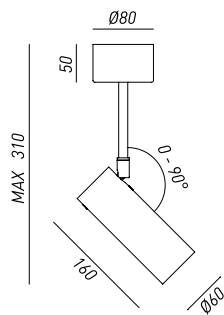

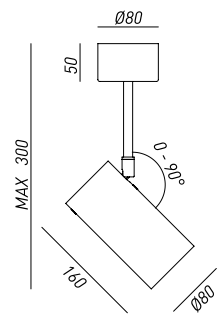

214.10.00  
214.10.ON  
214.10.FF  
1x Max 35W GU10



214.08.FF  
214.08.ON  
214.08.00  
1x Max 50W E27 PAR20

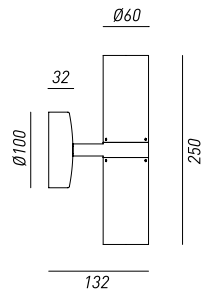



214.26.00  
 214.26.0N  
 214.26.FF  
 2x Max 35W GU10 

*dettaglio rosoni / canopie's details*



208.34-35  
 Ø 110 mm H 50 mm



208.31-33  
 Ø 80 mm H 50 mm

*finiture montatura / frame finishes*



OTTONE  
 BRASS



FERRO  
 IRON



OTTONE NATURALE  
 NATURAL BRASS

*finiture testa / shade finishes*



OTTONE  
 BRASS



FERRO  
 IRON



OTTONE NATURALE  
 NATURAL BRASS

**LONDON**





LO STILE INTERNAZIONALE  
INCONTRA LE LINEE DELLA  
TRADIZIONE CARATTERIZZANDO  
LONDON, COLLEZIONE COMPOSTA  
DA SOSPENSIONI, APPLIQUE E  
PLAFONIERE. LA STRUTTURA,  
REALIZZATA IN FERRO ANTICATO,  
È RESA PERCEPIBILE DALLE  
TRASPARENZE DEL VETRO CREANDO  
COSÌ INASPETTATI CAMBI DI VISIONE  
IN UN'ATMOSFERA LEGGERA E DI  
GRANDE FASCINO.

THE INTERNATIONAL STYLE MEETS  
THE LINES OF THE TRADITION THUS  
OUTLINING LONDON, A COLLECTION  
COMPOSED OF SUSPENSIONS,  
APPLIQUES AND CEILING LAMPS.  
THE STRUCTURE, MADE OF  
ANTIQUÉ IRON, IS PERCEPTIBLE  
BY THE TRANSPARENCY OF GLASS,  
CREATING UNEXPECTED CHANGES  
OF VISION IN A SOFT AND OF GREAT  
CHARM ATMOSPHERE.



























lampade / lamps

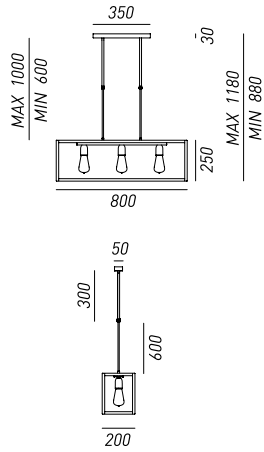

205.04.FF  
3x Max 77W E27

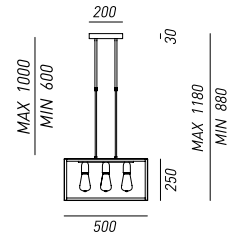

205.05.FF  
4x Max 77W E27

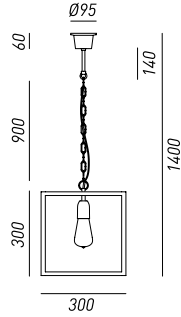

205.02.FF  
1x Max 77W E27

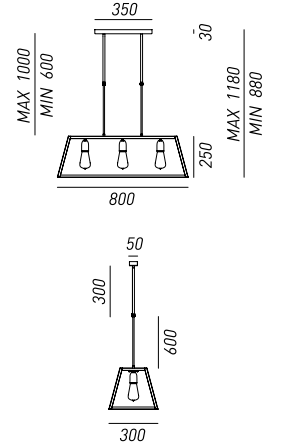

205.24.FF  
3x Max 77W E27

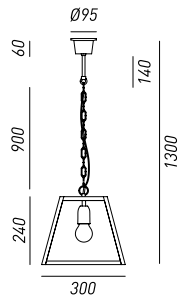

205.21.FF  
1x Max 77W E27

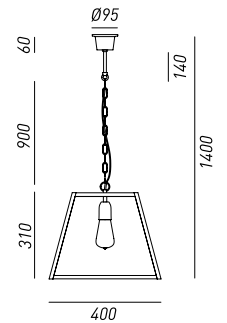

205.22.FF  
1x Max 77W E27

*lampade / lamps*

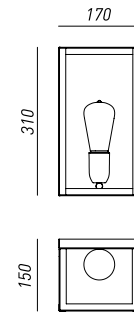
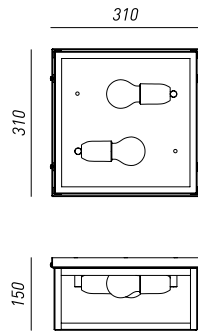
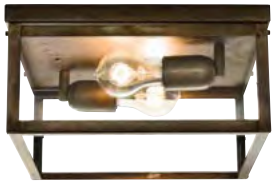

205.06.FF  
2x Max 46W E27 

205.09.FF  
1x Max 46W E27 

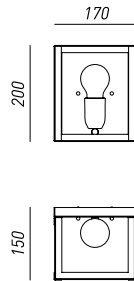

205.08.FF  
1x Max 46W E27 

*dettaglio rosoni / canopie's details*



205.04-24  
L 350 mm H 30 mm

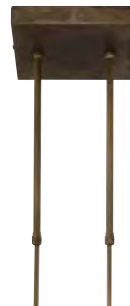

205.05  
L 200 mm H 30 mm



205.02-22-21  
Ø 95 mm H 60 mm

*finiture montatura / frame finishes*



FERRO  
IRON



VETRO TRASPARENTE  
TRANSPARENT GLASS

**GALILEO**







IL TRATTO GRAFICO DECISO E LA PERFETTA MEZZA SFERA CARATTERIZZANO QUESTA COLLEZIONE DI LAMPADE, CHE SI CONFIGURA COME UN OMAGGIO ALLA RIVOLUZIONE ASTRONOMICA. IL CONTRASTO TRA L'ESTERNO IN OTTONE O FERRO E L'INTERNO REALIZZATO IN FOGLIA ORO, ARGENTO O RAME, CONFERISCE A QUESTO PRODOTTO UN VALORE ESTETICO DI GRANDE EFFETTO VISIVO. DISPONIBILE CON ESTERNO IN OTTONE O FERRO NEI DIAMETRI 30, 40, 60 CM, E CON ESTERNO IN FERRO NEL DIAMETRO 80 CM.

THE FIRM GRAPHIC LINE AND THE PERFECT HALF SPHERE CHARACTERIZE THIS COLLECTION OF LAMPS, DESIGNED AS A TRIBUTE TO THE ASTRONOMICAL REVOLUTION. THE CONTRAST BETWEEN THE OUTER LOOK MADE OF BRASS OR IRON AND THE INTERIOR ONE DONE WITH GOLD, SILVER OR COPPER FOIL, ASCRIBES THIS PRODUCT AN AESTHETIC VALUE OF GREAT VISUAL EFFECT. AVAILABLE IN BRASS OR IRON EXTERIOR FOR DIAMETERS 30, 40, 60 CM AND IN IRON EXTERIOR FOR DIAMETER 80 CM.





ESEMPI DI FINITURE / EXAMPLES OF FINISHES







lampade / lamps

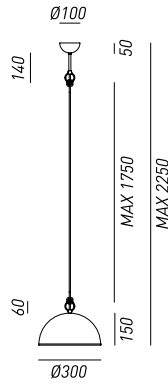

251.07.00 251.07.FF  
 251.07.094 251.07.F94  
 251.07.095 251.07.F95  
 251.07.096 251.07.F96  
 1x Max 46W E27



251.08.00 251.08.FF  
 251.08.094 251.08.F94  
 251.08.095 251.08.F95  
 251.08.096 251.08.F96  
 1x Max 77W E27

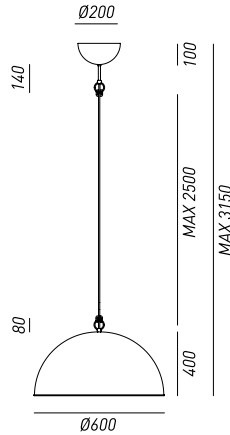

251.10.00 251.10.FF  
 251.10.094 251.10.F94  
 251.10.095 251.10.F95  
 251.10.096 251.10.F96  
 1x Max 77W E27

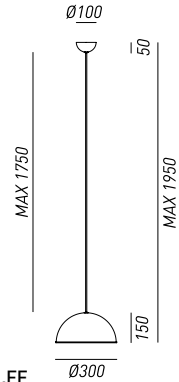

251.01.00 251.01.FF 251.31.00 251.31.FF  
 251.01.094 251.01.F94 251.31.094 251.31.F94  
 251.01.095 251.01.F95 251.31.095 251.31.F95  
 251.01.096 251.01.F96 251.31.096 251.31.F96  
 1x Max 46W E27 LED 8,7W 3000K

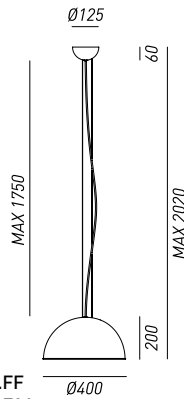

251.02.00 251.02.FF 251.32.00 251.32.FF  
 251.02.094 251.02.F94 251.32.094 251.32.F94  
 251.02.095 251.02.F95 251.32.095 251.32.F95  
 251.02.096 251.02.F96 251.32.096 251.32.F96  
 1x Max 77W E27 LED 20W 3000K

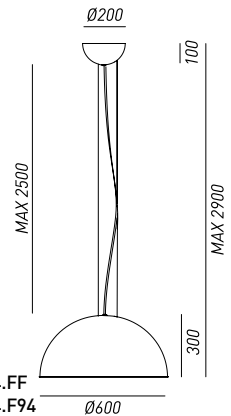

251.04.00 251.04.FF 251.34.00 251.34.FF  
 251.04.094 251.04.F94 251.34.094 251.34.F94  
 251.04.095 251.04.F95 251.34.095 251.34.F95  
 251.04.096 251.04.F96 251.34.096 251.34.F96  
 1x Max 77W E27 LED 30W 3000K

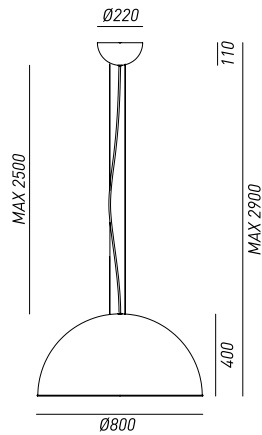

251.06.FF  
251.06.F94  
251.06.F95  
251.06.F96  
1x Max 77W E27

251.36.FF  
251.36.F94  
251.36.F95  
251.36.F96  
LED 43W 3000K



210.02.01 210.02.F1  
1x Max 77W E27   
210.12.00 210.12.FF  
LED 13W 3000K



210.03.01 210.03.F1  
1x Max 77W E27   
210.13.00 210.13.FF  
LED 8,7W 3000K

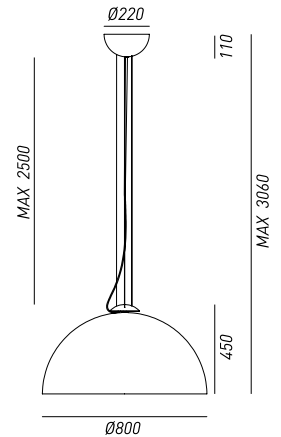

257.24.FF  
LED 43W 3000K  
257.34.FF  
4x Max 46W E27   
IP55

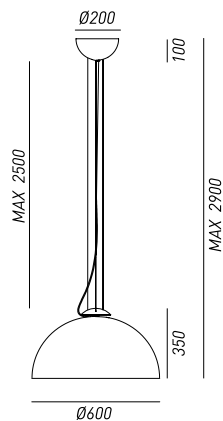

257.23.FF  
LED 30W 3000K  
257.33.FF  
3x Max 46W E27   
IP55

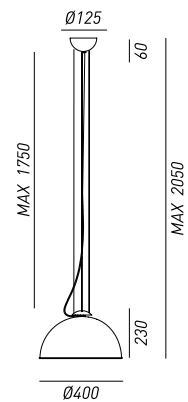

257.22.FF  
LED 20W 3000K  
257.32.FF  
2x Max 46W E27   
IP55

*dettaglio rosoni / canopie's details*

251.08  
Ø 125 mm H 60 mm



251.10  
Ø 200 mm H 100 mm



251.06  
257.04  
Ø 220 mm H 110 mm



251.02  
257.02  
Ø 125 mm H 60 mm



251.04  
257.03  
Ø 200 mm H 100 mm

---

descrizione codici / codes description

Ø 300 mm 251.01 251.07 | Ø 400 mm 251.02 251.08 | Ø 600 mm 251.04 251.10

- 00** ESTERNO OTTONE - INTERNO OTTONE / BRASS EXTERIOR - BRASS INTERIOR
- 094** ESTERNO OTTONE - INTERNO FOGLIA RAME / BRASS EXTERIOR - COPPER FOIL INTERIOR
- 095** ESTERNO OTTONE - INTERNO FOGLIA ARGENTO / BRASS EXTERIOR - SILVER FOIL INTERIOR
- 096** ESTERNO OTTONE - INTERNO FOGLIA ORO / BRASS EXTERIOR - GOLD FOIL INTERIOR
  
- FF** ESTERNO FERRO - INTERNO FERRO / IRON EXTERIOR - IRON INTERIOR
- F94** ESTERNO FERRO - INTERNO FOGLIA RAME / IRON EXTERIOR - COPPER FOIL INTERIOR
- F95** ESTERNO FERRO - INTERNO FOGLIA ARGENTO / IRON EXTERIOR - SILVER FOIL INTERIOR
- F96** ESTERNO FERRO - INTERNO FOGLIA ORO / IRON EXTERIOR - GOLD FOIL INTERIOR

Ø 800 mm 251.06

- FF** ESTERNO FERRO - INTERNO FERRO / IRON EXTERIOR - IRON INTERIOR
- F94** ESTERNO FERRO - INTERNO FOGLIA RAME / IRON EXTERIOR - COPPER FOIL INTERIOR
- F95** ESTERNO FERRO - INTERNO FOGLIA ARGENTO / IRON EXTERIOR - SILVER FOIL INTERIOR
- F96** ESTERNO FERRO - INTERNO FOGLIA ORO / IRON EXTERIOR - GOLD FOIL INTERIOR

**POGGIO**







LA RICERCATA E COMPLESSA LAVORAZIONE DELLA COLLEZIONE POGGIO, REALIZZATA IN OTTONE E FERRO, È VOLTA ALLA CREAZIONE DI OGGETTI IN GRADO DI RACCHIUDERE L'EREDITÀ CULTURALE DEL DESIGN ITALIANO DEGLI ANNI '40. FORME PULITE E LIBERE DA OGNI COSTRIZIONE CARATTERIZZANO QUESTE LAMPADE, RAPPRESENTATIVE DI UN HERITAGE PURO E AUTENTICO.

THE SOPHISTICATED AND COMPLEX PROCESSING OF THE BRASS AND IRON POGGIO COLLECTION IS A CREATION OF OBJECTS THAT CAN ENCOMPASS THE CULTURAL HERITAGE OF ITALIAN DESIGN OF THE 40S. WITH THEIR CLEAN AND CONSTRAINT-FREE SHAPES, THESE LAMPS REPRESENT A PURE AND AUTHENTIC HERITAGE.







*lampade / lamps*

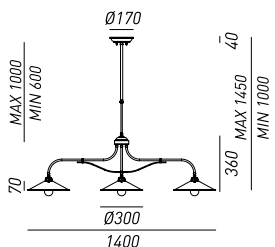

203.11.00  
203.11.0F  
3x Max 77W E27

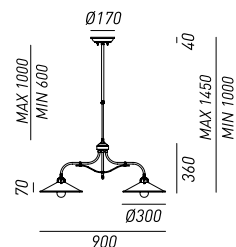

203.10.00  
203.10.0F  
2x Max 77W E27

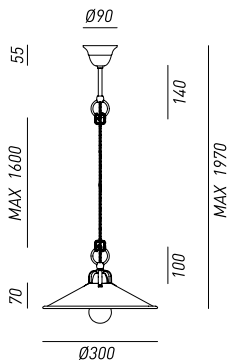

203.09.00  
203.09.0F  
1x Max 77W E27

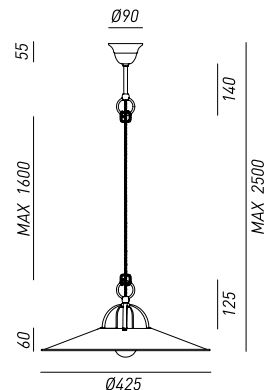

203.12.00  
203.12.0F  
1x Max 77W E27

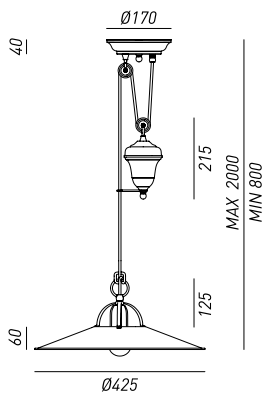

203.13.00  
203.13.0F  
1x Max 77W E27

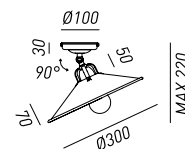

203.02.00  
203.02.0F  
1x Max 77W E27

*dettaglio rosoni / canopie's details*



203.10-11  
Ø 170 mm H 40 mm



203.09-12  
Ø 90 mm H 55 mm



203.13  
Ø 170 mm H 40 mm

*finiture montatura / frame finishes*



OTTONE  
BRASS

*finiture testa / shade finishes*



OTTONE  
BRASS



FERRO  
IRON

**CANTINA**







VOLUTAMENTE ISPIRATE  
ALL'ARREDAMENTO TIPICO  
DI CANTINE E LABORATORI  
ARTIGIANALI, QUESTE LAMPADE  
SONO CARATTERIZZATE DA PIATTI  
LEVIGATI IN OTTONE O FERRO  
ANTICATO. L'ESSENZIALITÀ DELLE  
FORME È ELEMENTO DISTINTIVO  
DELLA COLLEZIONE CANTINA:  
PRODOTTI MODERNI E VERSATILI  
ADATTABILI AD OGNI AMBIENTE.

PURPOSELY INSPIRED BY  
FURNISHINGS TYPICAL OF CELLARS  
AND WORKSHOPS, THESE LAMPS  
ARE CHARACTERIZED BY FLAT  
POLISHED BRASS OR ANTIQUE IRON.  
THE SIMPLICITY OF THE FORMS IS  
THE DISTINCTIVE ELEMENT OF THE  
COLLECTION CANTINA: MODERN AND  
VERSATILE PRODUCTS ADAPTABLE  
TO ANY ENVIRONMENT.





*lampade / lamps*

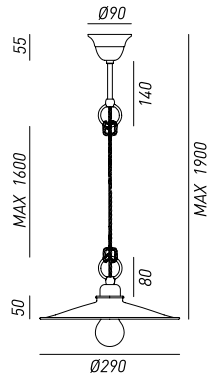

201.10.00  
201.10.FF  
1x Max 57W E27

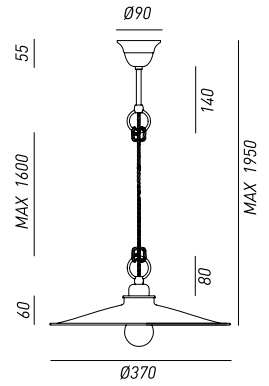

201.11.00  
201.11.FF  
1x Max 57W E27

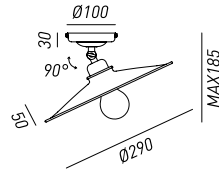

201.02.00  
201.02.FF  
1x Max 57W E27

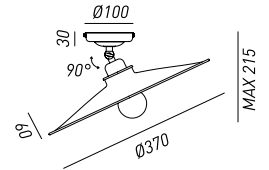

201.03.00  
201.03.FF  
1x Max 57W E27

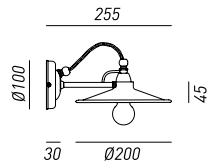

201.04.00  
201.04.FF  
1x Max 46W E14

*dettaglio rosoni / canopie's details*



201.10-11  
Ø 90 mm H 55 mm

*finiture montatura / frame finishes*



OTTONE  
BRASS



FERRO  
IRON

*finiture testa / shade finishes*



OTTONE  
BRASS



FERRO  
IRON

**CASCINA**





L'IMPATTO VISIVO FORTEMENTE  
MATERICO E IL RIGOROSO DISEGNO  
CARATTERIZZANO I PRODOTTI  
DELLA COLLEZIONE CASCINA.  
REALIZZATE IN OTTONE E/O FERRO  
ANTICATO, QUESTE LAMPADE  
ROMPONO LA LINEARITÀ DEGLI  
AMBIENTI STRAVOLGENDO I CANONI  
SCENOGRAFICI CLASSICI.

THE HIGHLY MATERIAL VISUAL  
IMPACT AND STRICT DESIGN  
CHARACTERIZE THE PRODUCTS OF  
THE CASCINA COLLECTION. MADE  
OF BRASS AND/OR ANTIQUE IRON,  
THESE LAMPS BREAK THE LINEARITY  
OF THE ENVIRONMENTS TWISTING  
THE CLASSICAL THEATRICAL  
CANONS.









lampade / lamps

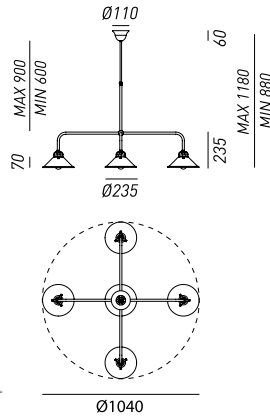

204.25.00  
5x Max 46W E27

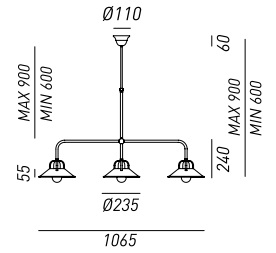

204.10.00  
3x Max 46W E27

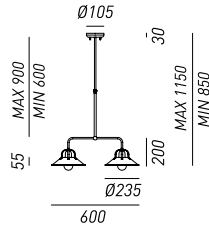

204.09.00  
2x Max 46W E27

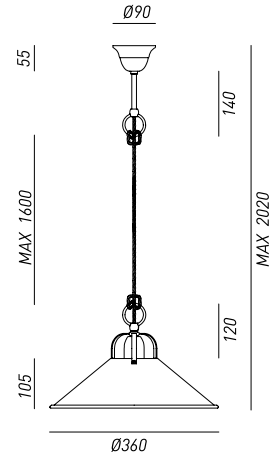

204.08.00  
204.08.0F  
1x Max 46W E27

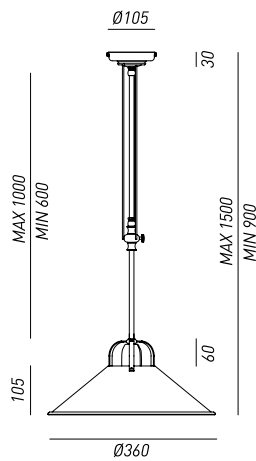

204.11.00  
204.11.0F  
1x Max 46W E27

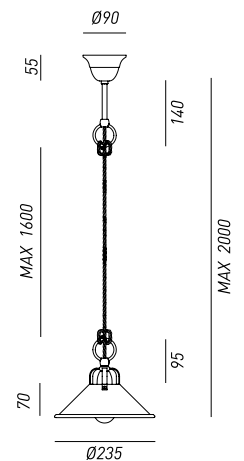

204.07.00  
1x Max 46W E27

*lampade / lamps*

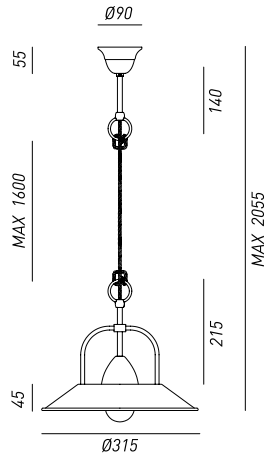

204.12.00  
204.12.0F  
1x Max 46W E27

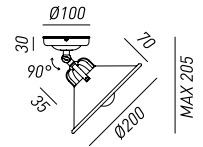

204.23.00  
1x Max 46W E14

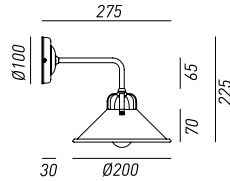

204.05.00  
1x Max 46W E14

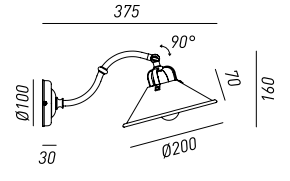

204.04.00  
1x Max 46W E14

*dettaglio rosoni / canopie's details*



204.10-25  
Ø 110 mm H 60 mm



204.09  
Ø 100 mm H 30 mm





204.08-07-12  
Ø 90 mm H 55 mm



204.11  
Ø 105 mm H 30 mm

*finiture montatura / frame finishes*



OTTONE  
BRASS

*finiture testa / shade finishes*



OTTONE  
BRASS



FERRO  
IRON

**COUNTRY**



LINGUAGGIO COUNTRY  
INTERNAZIONALE E TRADIZIONE  
MILLENNARIA DEL VETRO DI MURANO,  
GRANDE ESPRESSIONE DEL MADE  
IN ITALY, SI FONDONO ALLA  
PERFEZIONE NELLA COLLEZIONE  
COUNTRY. PRODOTTE IN OTTONE E  
VETRO SOFFIATO BIANCO, QUESTE  
LAMPADRE SONO PECULIARMENTE  
CARATTERIZZATE DAL BORDO  
RIBRUCIATO MARRONE.

INTERNATIONAL COUNTRY  
LANGUAGE AND MILLENNIAL  
TRADITION OF MURANO GLASS,  
GREAT EXPRESSION OF MADE IN  
ITALY, BLEND PERFECTLY INTO THE  
COUNTRY COLLECTION. PRODUCED  
IN BRASS WITH WHITE BLOWN  
GLASS, THESE  
LAMPS ARE PARTICULARLY  
CHARACTERIZED BY A BURNT BROWN  
RIM.







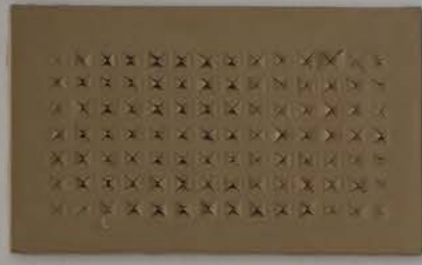

Lampade / lamps

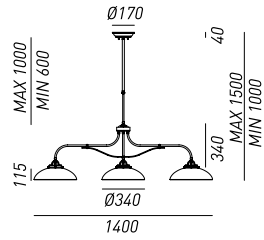

080.09.OV  
3x Max 77W E27

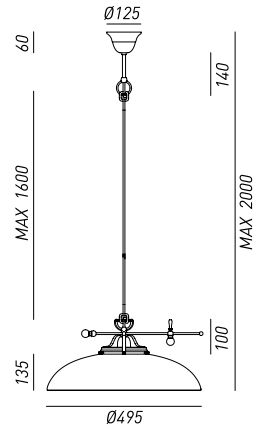

080.10.OV  
1x Max 77W E27

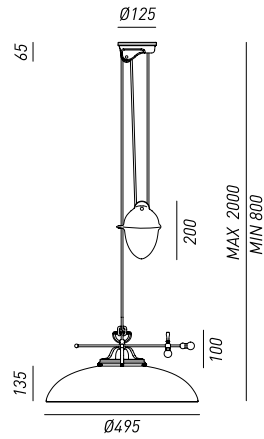

080.11.OV  
1x Max 77W E27

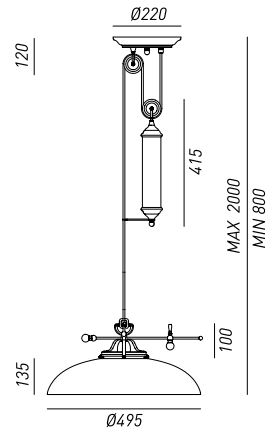

080.12.OV  
1x Max 77W E27

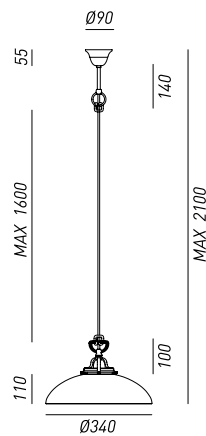

082.10.OV  
1x Max 77W E27

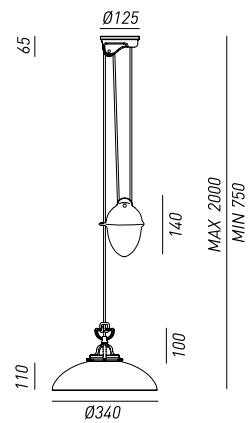

082.11.OV  
1x Max 77W E27



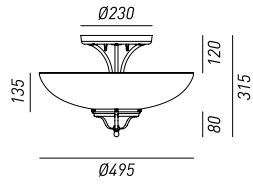

080.02.OV  
3x Max 46W E27

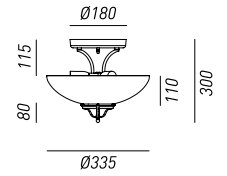

082.02.OV  
3x Max 46W E14

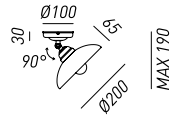

082.23.OV  
1x Max 46W E14

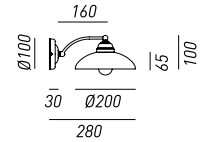

082.17.OV  
1x Max 46W E14

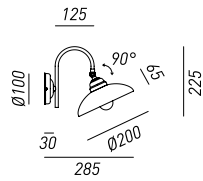

082.19.OV  
1x Max 46W E14

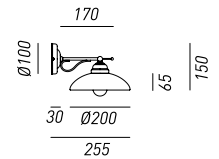

082.14.OV  
1x Max 46W E14

*dettaglio rosoni / canopie's details*

080.12  
Ø 220 mm H 120 mm



080.09  
Ø 170 mm H 40 mm



080.10  
Ø 110 mm H 60 mm



082.10  
Ø 90 mm H 55 mm



080.11  
082.11  
Ø 125 mm H 65 mm

---

*finiture montatura / frame finishes*



OTTONE  
BRASS



CERAMICA  
CERAMIC

---

*finiture testa / shade finishes*

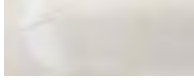

VETRO  
GLASS





lampade / lamps

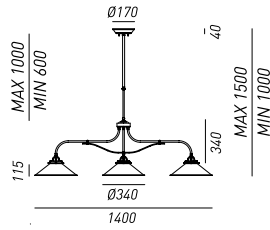

081.09.OV  
3x Max 77W E27

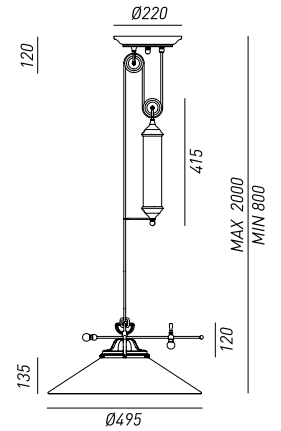

083.12.OV  
1x Max 77W E27

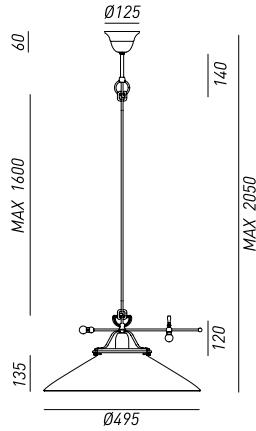

083.10.OV  
1x Max 77W E27

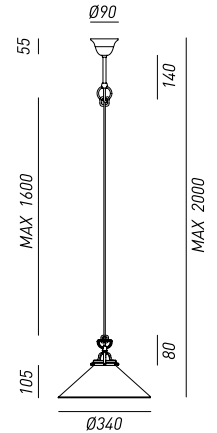

081.10.OV  
1x Max 77W E27

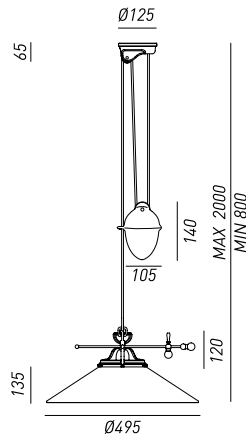

083.11.OV  
1x Max 77W E27

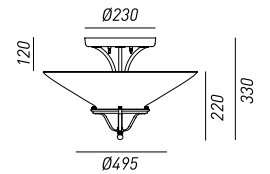

083.02.OV  
3x Max 46W E27

*lampade / lamps*

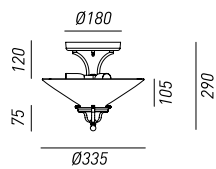

**081.02.OV**  
3x Max 46W E14

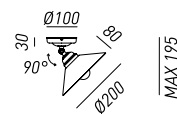

**081.23.OV**  
1x Max 46W E14

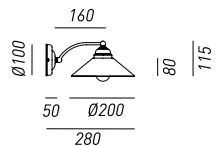

**081.17.OV**  
1x Max 46W E14

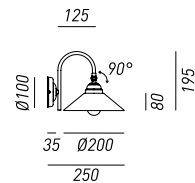

**081.19.OV**  
1x Max 46W E14

*dettaglio rosone / canopie's details*



**081.10**  
Ø 90 mm H 55 mm



**083.10**  
Ø 125 mm H 60 mm



083.12  
Ø 220 mm H 120 mm



080.09  
Ø 170 mm H 40 mm



083.11  
Ø 125 mm H 65 mm

*finiture montatura / frame finishes*



OTTONE  
BRASS



CERAMICA  
CERAMIC

*finiture testa / shade finishes*



VETRO  
GLASS

**MINI**







MINI È UNA COLLEZIONE DI APPLIQUE  
E FARETTI REALIZZATI IN CERAMICA  
E OTTONE ANTICATO. IL PROFILO  
RICERCATO CARATTERIZZA QUESTI  
PRODOTTI COME ELEMENTI DI UN  
DESIGN GIOVANE E ATTUALE.

MINI IS A COLLECTION OF SCONCES  
AND SPOTLIGHTS MADE OF  
CERAMICS AND ANTIQUE BRASS.  
THE REFINED PROFILE CHARACTERIZES  
THESE PRODUCTS AS PART OF A  
YOUNG AND CURRENT DESIGN.







Lampade / lamps

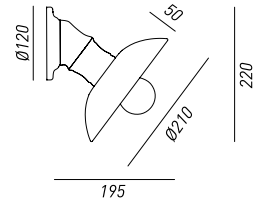
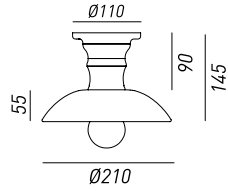

064.02.0C  
1x Max 46W E27



064.04.0C  
1x Max 46W E27

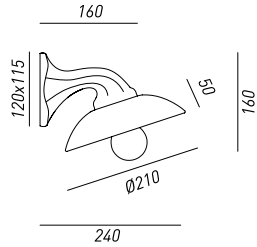

064.05.0C  
1x Max 46W E27

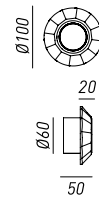
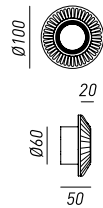

208.07.00  
1x Max 35W GU5.3



208.17.00  
1x Max 35W GU10



208.09.00  
1x Max 35W GU5.3





208.19.00  
11x Max 35W GU10

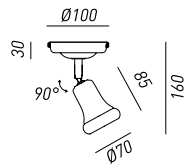

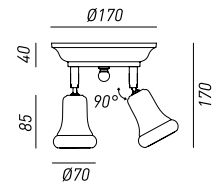

208.23.00  
1x Max 35W GU10 



208.22.00  
2x Max 35W GU10 

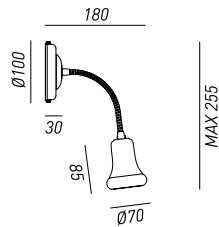

208.20.00  
1x Max 35W GU10 

finiture montatura / frame finishes



OTTONE  
BRASS



CERAMICA  
CERAMIC

finiture testa / shade finishes



OTTONE  
BRASS

# FIORI DI PIZZO







I RICAMI SAPIENTEMENTE TRAFORATI SULLE PREZIOSE CERAMICHE DI BASSANO CONFERISCONO UN GRANDE VALORE ESTETICO ALLE LAMPADE DELLA COLLEZIONE FIORI DI PIZZO, SIMBOLO DI UN CLASSICISMO RIVISITATO IN CHIAVE MODERNA. LA RICERCATA LAVORAZIONE CONSENTE, IN FASE DI ILLUMINAZIONE, LA CREAZIONE DI GIOCHI DI LUCE SULLE PARETI PROIETTANDO FIORI E DECORI.

THE EMBROIDERIES EXPERTLY DRILLED ON PRECIOUS CERAMICS OF BASSANO GIVE A GREAT AESTHETIC VALUE TO THE LAMPS OF THE FIORI DI PIZZO COLLECTION, A SYMBOL OF A MODERN REINTERPRETATION OF CLASSICISM. THE SOPHISTICATED PROCESSING ALLOWS, IN STAGE OF ILLUMINATION, THE CREATION OF THE PLAY OF LIGHT ON THE WALLS PROJECTING FLOWERS AND DECORATIONS.







*lampade / lamps*

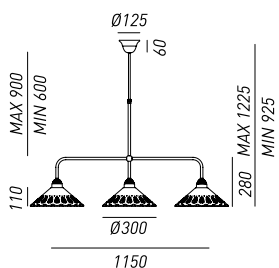

065.25.0C  
3x Max 46W E27

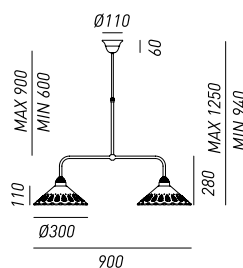

065.24.0C  
2x Max 46W E27

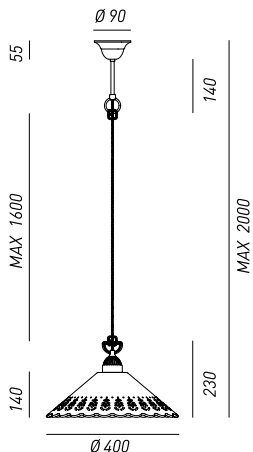

065.09.0C  
1x Max 77W E27

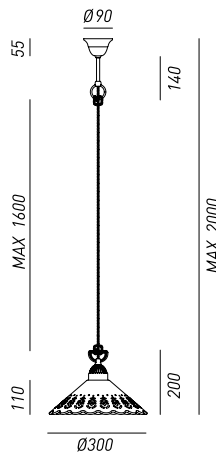

065.08.0C  
1x Max 46W E27

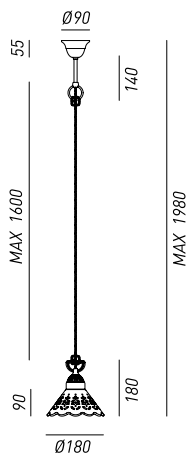

065.07.0C  
1x Max 46W E27

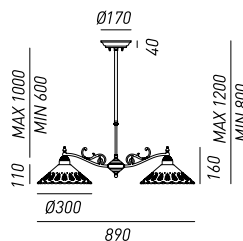

065.10.0C  
2x Max 46W E27

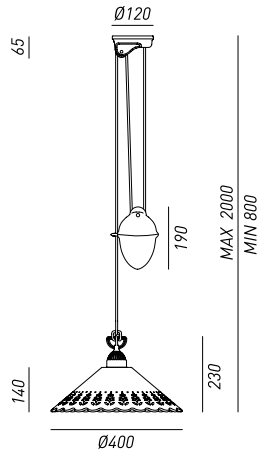

065.11.OC  
1x Max 77W E27

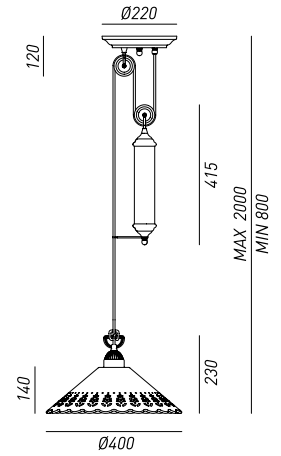

065.12.OC  
1x Max 77W E27

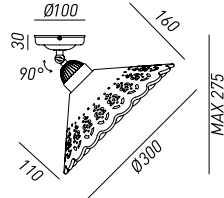

065.02.OC  
1x Max 46W E27

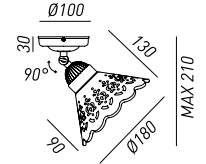

065.23.OC  
1x Max 46W E27

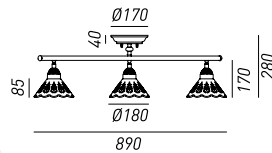

065.21.OC  
3x Max 46W E27

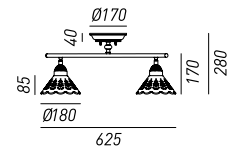

065.22.OC  
2x Max 46W E27

*lampade / lamps*

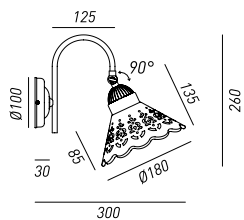

**065.19.OC**  
1x Max 46W E27

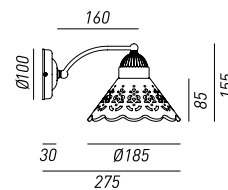

**065.17.OC**  
1x Max 46W E27

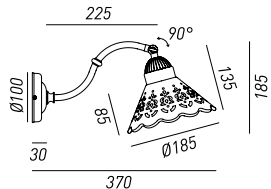

**065.18.OC**  
1x Max 46W E27

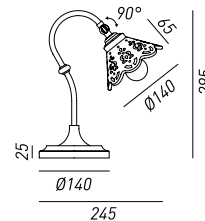

**065.52.OC**  
1x Max 46W E14

*dettaglio rosoni / canopie's details*



**065.24-25**  
Ø 125 mm H 60 mm



**065.10**  
Ø 170 mm H 40 mm





065.07-08-09  
 Ø 90 mm H 55 mm



065.11  
 Ø 120 mm H 65 mm



065.12  
 Ø 220 mm H 120 mm

*finiture montatura / frame finishes*



OTTONE  
 BRASS



CERAMICA  
 CERAMIC

*finiture testa / shade finishes*



CERAMICA  
 CERAMIC

**ANITA**



L'ECCELLENTE EQUILIBRIO TRA ELEGANZA DELLO STILE LIBERTY E MODERNO COMFORT FA DI QUESTA COLLEZIONE UN CAPOLAVORO DI MAESTRIA ARTIGIANALE, CONTRADDISTINTA DA DETTAGLI SAPIENTEMENTE RICERCATI. LE FAMOSE CERAMICHE DI BASSANO CON CUI SONO REALIZZATE LE LAMPADE ANITA, CONFERISCONO VALORE AGGIUNTO A QUESTE CREAZIONI.

THE OUTSTANDING BALANCE OF ELEGANCE IN THE ART NOUVEAU STYLE AND MODERN COMFORT MAKE THIS COLLECTION A MASTERPIECE OF CRAFTSMANSHIP, CHARACTERIZED BY EXPERTLY RESEARCHED DETAILS. THE FAMOUS CERAMICS OF BASSANO USED TO MAKE THESE LAMPS, ADD ADDITIONAL VALUE TO THESE CREATIONS.











lampade / lamps

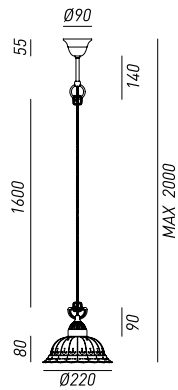

061.07.OC  
1x Max 46W E27

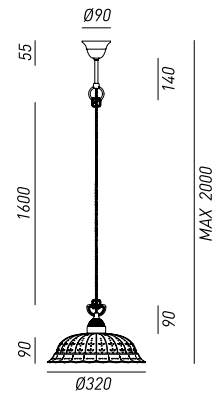

061.08.OC  
1x Max 46W E27

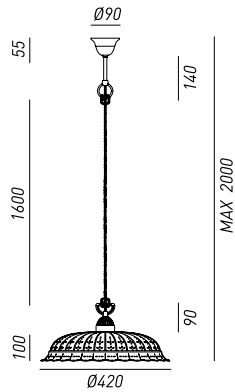

061.09.OC  
1x Max 77W E27

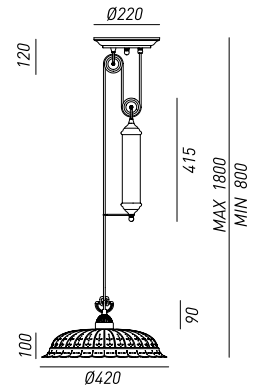

061.12.OC  
1x Max 77W E27

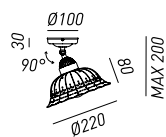

061.23.OC  
1x Max 46W E27

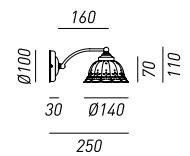

061.17.OC  
1x Max 46W E14

Lampade / lamps

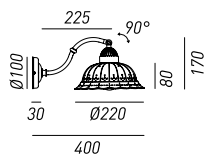

061.18.0C  
1x Max 46W E27

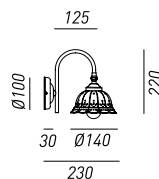

061.19.0C  
1x Max 46W E14

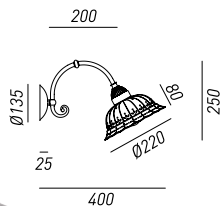

061.37.0C  
1x Max 46W E27

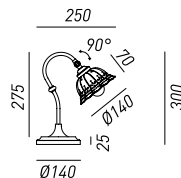

061.52.0C  
1x Max 46W E14

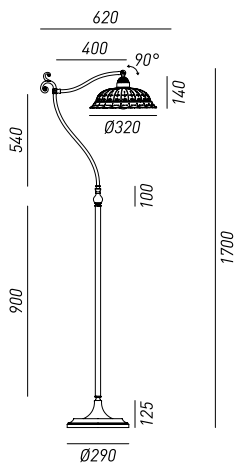

061.53.0C  
1x Max 77W E27

*dettaglio rosoni / canopie's details*



061.12  
Ø 220 mm H 120 mm



061.07-08-09  
Ø 90 mm H 55 mm

*finiture montatura / frame finishes*



OTTONE  
BRASS

*finiture testa / shade finishes*



CERAMICA  
CERAMIC

**TABIÀ**





REALIZZATE IN VETRO E MONTATURE  
IN OTTONE ANTICATO, QUESTE  
LAMPADIE RAPPRESENTANO LA  
PIÙ ALTA ESPRESSIONE DELLO  
STILE NEW CLASSIC. L'INTERA  
COLLEZIONE SEGNA L'ATTENTA  
RICERCA DELLA SEMPLIFICAZIONE  
E DEL MINIMALISMO STILISTICO  
RIVISITANDO IN CHIAVE MODERNA  
MATERIALI TIPICI DELLA TRADIZIONE  
ITALIANA.

MADE OF GLASS AND FRAMES IN  
ANTIQUÉ BRASS, THESE LAMPS  
ARE THE HIGHEST EXPRESSION OF  
NEW CLASSIC STYLE. THE ENTIRE  
COLLECTION MARKS THE CAREFUL  
RESEARCH OF SIMPLICITY AND  
STYLISTIC MINIMALISM REVISITING IN  
MODERN MATERIALS TYPICAL OF THE  
ITALIAN TRADITION.









lampade / lamps

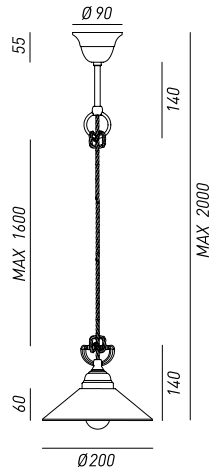

212.07.OV  
1x Max 46W E14

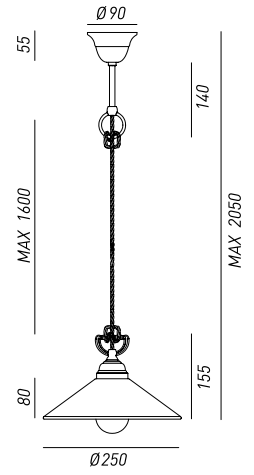

212.08.OV  
1x Max 77W E27

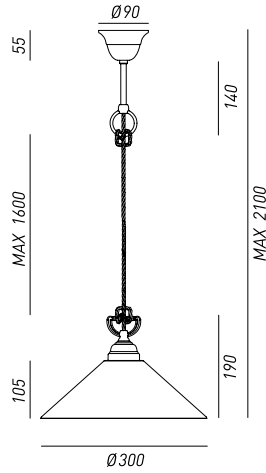

212.09.OV  
1x Max 77W E27

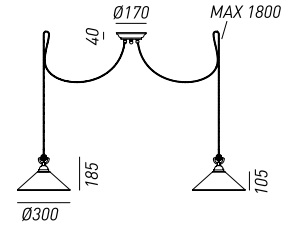

212.10.OV  
2x Max 77W E27

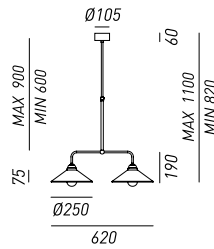

212.24.OV  
2x Max 77W E27

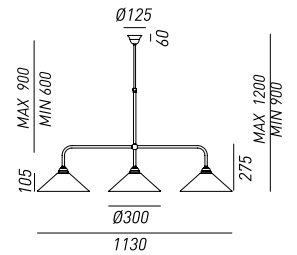

212.25.OV  
3x Max 77W E27

lampade / lamps

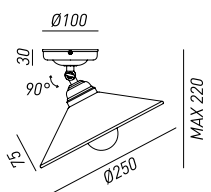

212.02.OV  
1x Max 77W E27

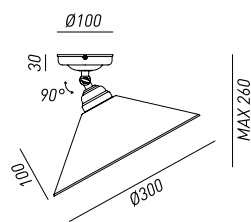

212.03.OV  
1x Max 77W E27

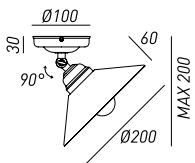

212.23.OV  
1x Max 46W E14

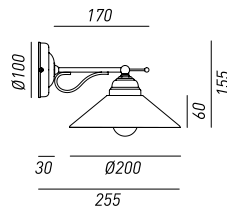

212.14.OV  
1x Max 46W E14

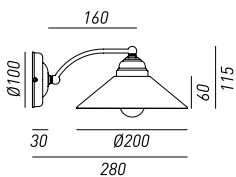

212.17.OV  
1x Max 46W E14

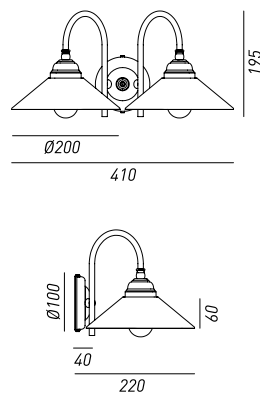

212.20.OV  
2x Max 46W E14

*dettaglio rosoni / canopie's details*



212.10  
Ø 170 mm H 40 mm



212.07-08-09  
Ø 90 mm H 55 mm



212.25-24  
Ø 110 mm H 60 mm

*finiture montatura / frame finishes*



OTTONE  
BRASS

*finiture testa / shade finishes*



VETRO  
GLASS

**CONTRADA**







IL PURISMO STILISTICO  
CONTRASSEGNA LA COLLEZIONE  
CONTRADA: LAMPADE DAL DESIGN  
RIGOROSO ED ESSENZIALE  
REALIZZATE IN RAME E OTTONE  
ANTICATO. IL MATERIALE, RICERCATO  
E DI GRANDE QUALITÀ, CONFERISCE  
A QUESTI PRODOTTI UN GRANDE  
IMPATTO MATERICO.

THE STYLISTIC PURISM MARKS THE  
CONTRADA COLLECTION: LAMPS  
WITH RIGOROUS AND ESSENTIAL  
DESIGN MADE OF COPPER AND  
ANTIQUÉ BRASS. THE SOPHISTICATED  
AND OF HIGH QUALITY MATERIAL,  
GIVES THESE PRODUCTS A GREAT  
MATERIAL IMPACT.





Lampade / lamps

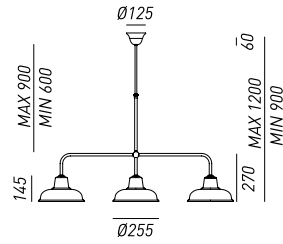

211.11.OR  
3x Max 77W E27



243.02.OR  
1x Max 77W E27   
IP 20

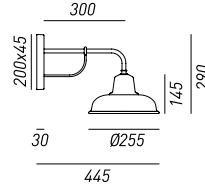

243.05.OR  
1x Max 77W E27   
IP 23

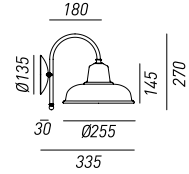

243.06.OR  
1x Max 77W E27   
IP 23

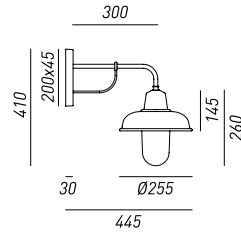

243.25.ORB  
243.25.ORT  
1x Max 57W E27   
1x Max 23W E27   
IP 44

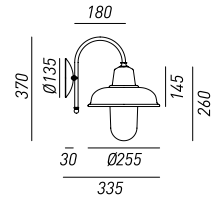

243.26.ORB  
243.26.ORT  
1x Max 57W E27   
1x Max 23W E27   
IP 44

*dettaglio rosoni / canopie's details*



211.11  
Ø 110 mm H 60 mm



243.07  
Ø 110 mm H 60 mm

*finiture montatura / frame finishes*



OTTONE  
BRASS

*finiture testa / shade finishes*



RAME  
COPPER

*vetro / glass*



VETRO BIANCO  
WHITE GLASS



VETRO TRASPARENTE  
TRANSPARENT GLASS

**BARCHESSA**







IL DESIGN MINIMALISTA E CONCETTUALE DELLE LAMPADE DELLA COLLEZIONE BARCHESSA, REALIZZATE IN FERRO, OTTONE O RAME ANTICATO, RISALTA IL MASSIMO DELLA LORO FUNZIONALITÀ. LE FORME PULITE E LIBERE DA QUALSIASI ARTIFICIOSITÀ SIMBOLEGGIANO IN MANIERA ESCLUSIVA QUESTI PRODOTTI, VISIBILMENTE ISPIRATI ALL'ARTE POVERA.

THE MINIMALIST AND CONCEPTUAL DESIGN OF THE BARCHESSA LAMPS' COLLECTION MADE OF IRON, BRASS OR COPPER, BRINGS OUT THE MOST OF THEIR FUNCTIONALITY. CLEAN AND ARTIFICIALITY-FREE SHAPES SYMBOLIZE THE EXCLUSIVITY OF THESE PRODUCTS, VISIBLY INSPIRED BY POOR ART.











*lampade / lamps*

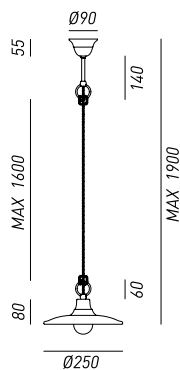

220.10.00  
220.10.0R  
1x Max 57W E27

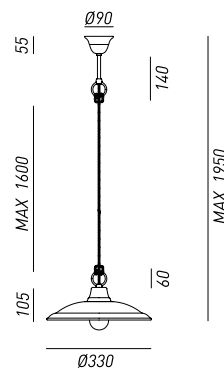

220.11.0R  
1x Max 77W E27

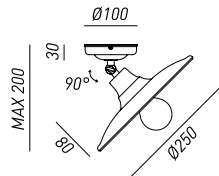

220.02.00  
220.02.0R  
1x Max 57W E27

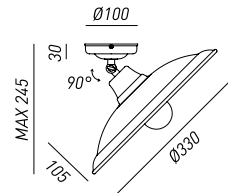

220.03.0R  
1x Max 77W E27

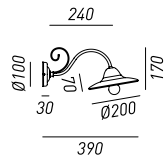

220.04.0R  
220.04.FO  
1x Max 46W E14

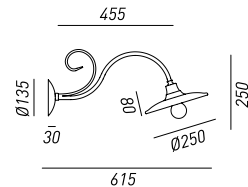

220.05.0R  
220.05.FO  
1x Max 77W E27



220.06.ORB  
1x Max 77W E27



220.07.ORB  
220.07.ORT  
1x Max 57W E27  
1x Max 23W E27  
IP 44

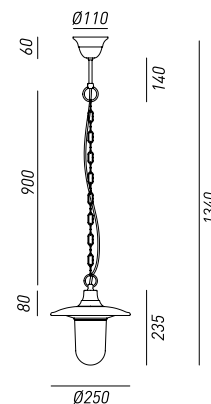

220.08.ORB  
220.08.ORT  
1x Max 57W E27  
1x Max 23W E27  
IP 44

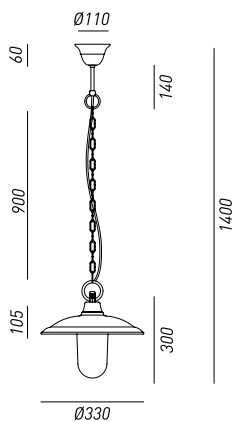

220.12.ORB  
220.12.ORT  
1x Max 57W E27  
1x Max 23W E27  
IP 44

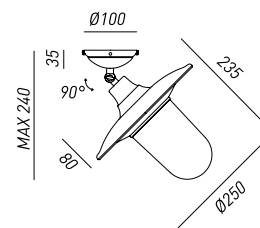

220.13.ORB  
220.13.ORT  
1x Max 75 W E27  
1x Max 23W E27  
IP 44

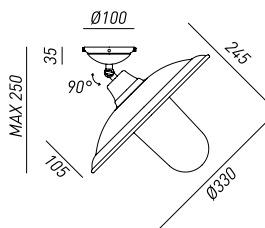

220.25.ORB  
220.25.ORT  
1x Max 57W E27  
1x Max 23W E27  
IP 44

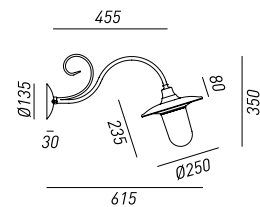

*lampade / lamps*



**220.26.ORB**  
**220.26.ORT**  
 1x Max 57W E27   
 1x Max 23W E27   
 IP 44

*pali / lamp posts*

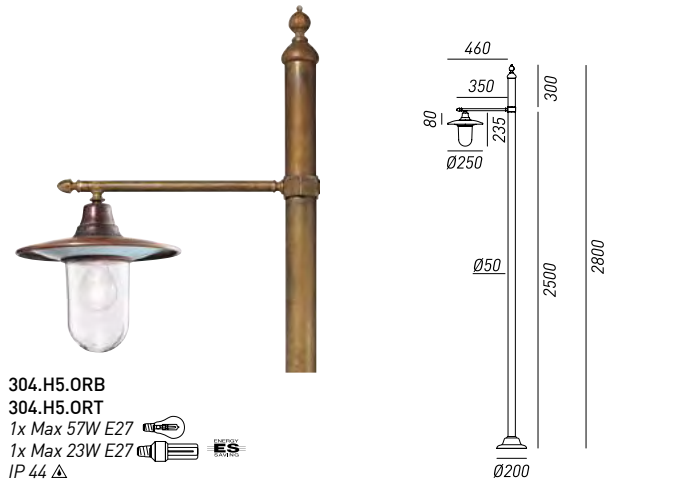

**304.H5.ORB**  
**304.H5.ORT**  
 1x Max 57W E27   
 1x Max 23W E27   
 IP 44

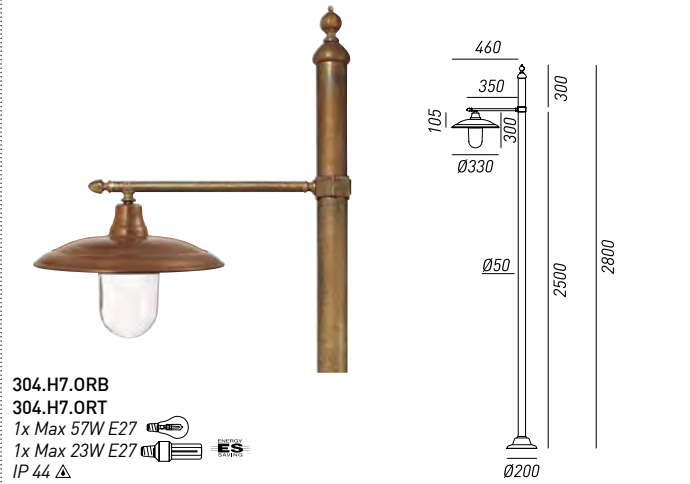

**304.H7.ORB**  
**304.H7.ORT**  
 1x Max 57W E27   
 1x Max 23W E27   
 IP 44

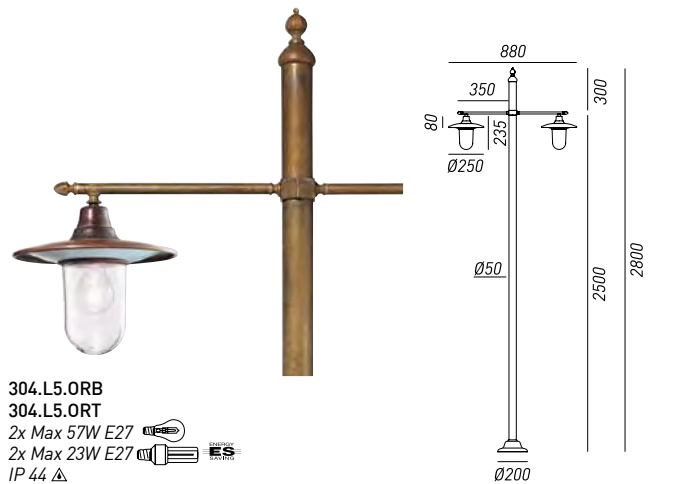



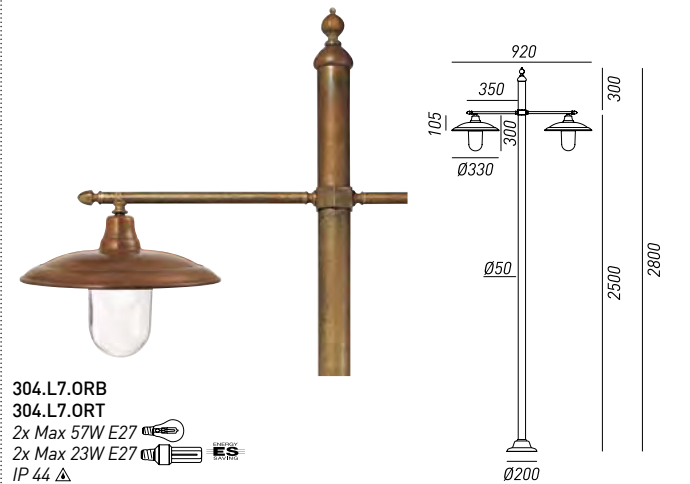

**304.L5.ORB**  
**304.L5.ORT**  
 2x Max 57W E27   
 2x Max 23W E27   
 IP 44



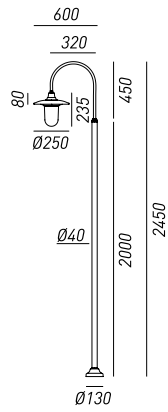



**304.L7.ORB**  
**304.L7.ORT**  
 2x Max 57W E27   
 2x Max 23W E27   
 IP 44



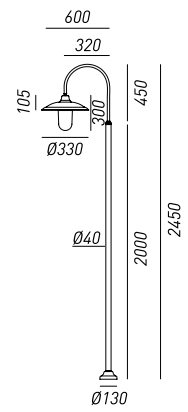

301.D5.ORB  
301.D5.ORT  
1x Max 57W E27   
1x Max 23W E27    
IP 44 



301.D7.ORB  
301.D7.ORT  
1x Max 57W E27   
1x Max 23W E27    
IP 44 

dettaglio rosone / canopie's details



220.07-08  
Ø 110 mm H 60 mm



220.10-11  
Ø 90 mm H 55 mm

finiture montatura / frame finishes



OTTONE  
BRASS

finiture testa / shade finishes



OTTONE  
BRASS

vetro / glass



VETRO BIANCO  
WHITE GLASS



VETRO TRASPARENTE  
TRANSPARENT GLASS

**DROP**





ISPIRATE ALLE LUCI DELLE SAGRE PAESANE, LE LAMPADE DELLA COLLEZIONE DROP RAPPRESENTANO UNA SOLUZIONE ORIGINALE PER L'ARREDAMENTO DEGLI AMBIENTI ESTERNI E INTERNI. TRASPARENZA E SEMPLICITÀ CONTRADDISTINGUONO QUESTE LAMPADE REALIZZATE IN OTTONE, RAME E VETRO, REINTERPRETAZIONE IN CHIAVE CONTEMPORANEA DELLA TRADIZIONALE FORMA A GOCCIA. PUNTI LUCE DAL DESIGN RICERCATO CHE ILLUMINANO GLI SPAZI CON ELEGANTE DISCREZIONE AMALGAMANDOSI CON IL PAESAGGIO.

INSPIRED BY TOWN FESTIVAL LIGHTS, THE DROP COLLECTION REPRESENT A UNIQUE SOLUTION FOR OUTDOOR AND INDOOR ENVIRONMENTS. THANKS TO THEIR TRANSPARENCY AND SIMPLICITY, THESE LAMPS MADE OF BRASS, COPPER AND GLASS GIVE A NEW CONTEMPORARY REINTERPRETATION OF THE TEARDROP FORM. THE LIGHT ILLUMINATES SPACES WITH ELEGANT DISCRETION THAT DISSOLVES INTO THE LANDSCAPE.











**MENU**

AVANA	-ARANCIA	-MELONE
ENZERO	-MELA	-CAROTA
MPELMO	-FRAGOLA	-FINOCCHIO
GURIA	-CILIEGIA	-LIME
BICOCCA	-PESCA	-MIRTILLO
MONTE	-KIWI	-BANANA
CCO	-MANGO	-PAPAIA

carbonato  
180 gr  
2 uova  
Vanillina

Mirtilli freschi  
Sale impiccico  
2 uova  
Vanillina

andendo il forni a 180° fate ammorbidire  
70° Temperata ambiente e poi sbatte  
mer, carmeni, assieme allo zucchero  
valere in un'ora, ma a che il composto rinfidi  
no. Rompete la uova in una ciotola e unitele  
la volta e lentamente, sempre sbattendo









**SISTEMA COMPOSTO DA / SYSTEM MADE OF:**

**Codici / Codes:** 1 X 270.06.00  
1 X 270.38.AA  
1 X 270.37.10  
4 X 270.10.00  
3 X 270.02.ORT



lampade / lamps

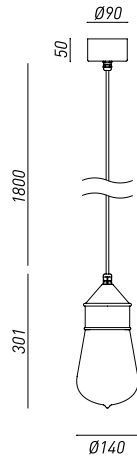

270.03.ORT  
1x Max 57W E27

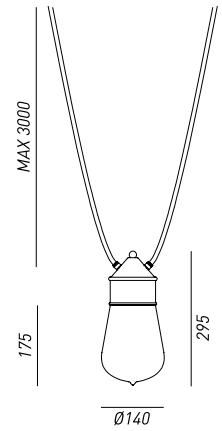

270.02.ORT  
1x Max 57W E27

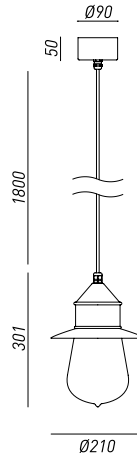

270.13.ORT  
1x Max 57W E27

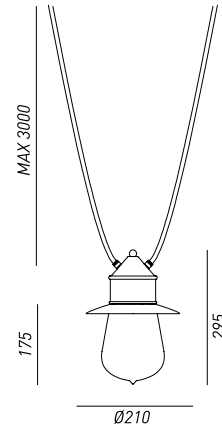

270.12.ORT  
1x Max 57W E27

dettaglio rosone / canopie's details



270.01-11  
Ø 90 mm H 50 mm

accessori / accessories

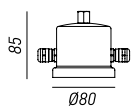

**270.10.00**  
 Ø 80 mm H 85 mm  
 Scatola di connessione per cavo d'acciaio.  
 Connection box for steel cable.  
 IP 44 ▲

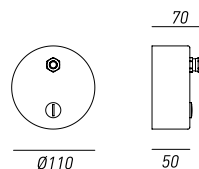

**270.06.00**  
 Ø 110 mm H 50 mm  
 Rosone da muro o soffitto con due stringicavo piu un tappo.  
 Wall or ceiling canopy with two cable glands and screw top.  
 IP 44 ▲

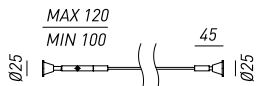

**270.08.AA**  
 Kit per cavo d'acciaio Ø 3 mm.  
 Kit for steel cable Ø 3 mm.

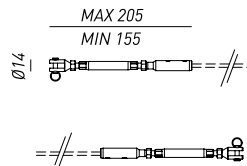

**270.38.AA**  
 Kit per cavo d'acciaio, Ø 4 mm  
 Kit for steel cable, Ø 4 mm

**270.07.05**  
 Cavo d'acciaio Ø 3 mm, 5 m.  
 Steel cable Ø 3 mm, 5 m.

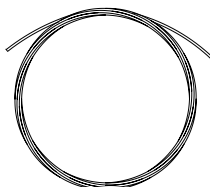

**270.37.10**  
 Cavo d'acciaio Ø 4 mm, 10 m  
 Steel cable Ø 4 mm, 10 m  
**270.37.20**  
 Cavo d'acciaio Ø 4 mm, 20 m  
 Steel cable Ø 4 mm, 20 m  
**270.37.30**  
 Cavo d'acciaio Ø 4 mm, 30 m  
 Steel cable Ø 4 mm, 30 m

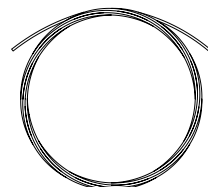

finiture montatura / frame finishes



**OTTONE**  
**BRASS**

finiture testa / shade finishes



**OTTONE**  
**BRASS**



**RAME**  
**COPPER**

vetro / glass



**VETRO TRASPARENTE**  
**TRANSPARENT GLASS**



**ATTENZIONE!!**

FINO A 3 LAMPADE E CON TRATTE INFERIORI O UGUALI AI 5 METRI UTILIZZARE GLI ARTICOLI:

- 270.07.05 (CAVO ACCIAIO Ø 3 mm, 5 m)
- 270.08.AA (KIT CAVO ACCIAIO Ø 3 mm)

**WARNING!!**

UP TO 3 LAMPS AND WITH CABLE SECTIONS LOWER OR UGUAL THAN 5 METERS, YOU HAVE TO USE THE FOLLOWING ITEMS:

- 270.07.05 (Ø 3 mm STEEL CABLE 5 m)
- 270.08.AA (KIT FOR STEEL CABLE Ø 3 mm)

**ATTENZIONE!!**

PIÙ DI 3 LAMPADE O CON TRATTE SUPERIORI AI 5 METRI UTILIZZARE GLI ARTICOLI:

- 270.37.10/20/30 (CAVO ACCIAIO Ø 4 mm, 10 m / 20 m / 30 m)
- 270.38.AA (KIT CAVO ACCIAIO Ø 4 mm)

**WARNING!!**

FOR MORE THAN 3 LAMPS OR WITH CABLE SECTIONS LONGER THAN 5 METERS, YOU HAVE TO USE THE FOLLOWING ITEMS:

- 270.37.10/20/30 (Ø 4 mm STEEL CABLE, 10 m / 20 m / 30 m)
- 270.38.AA (KIT FOR STEEL CABLE Ø 4 mm)

**LANTERNE**



LA LUCE TENUE E AMBRATA DIVENTA ASSOLUTA PROTAGONISTA DI QUESTA SERIE DI LAMPADE DI CHIARA ISPIRAZIONE ORIENTALEGGIANTE. I PRODOTTI DELLA COLLEZIONE LANTERNE, CON MONTATURE IN OTTONE O FERRO E VETRO TRASPARENTE, REINTERPRETANO IN CHIAVE CONTEMPORANEA TUTTO IL FASCINO DELLA TIPICA ATMOSFERA A LUME DI CANDELA.

THE SOFT AND AMBER LIGHT BECOMES AN ABSOLUTE PROTAGONIST OF THESE SERIES OF LAMPS CLEARLY INSPIRED BY ORIENTAL FEATURES. THE PRODUCTS OF LANTERNE COLLECTION, WITH FRAMES MADE OF BRASS OR IRON AND TRANSPARENT GLASS, REINTERPRET IN A CONTEMPORARY LIGHT ALL THE CHARM OF THE TYPICAL ATMOSPHERE OF CANDLELIGHT.















lampade / lamps

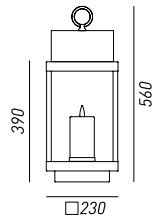

265.01.00  
265.01.FF  
1x Max 28W E27   
1x Max 12W E27   
IP 65

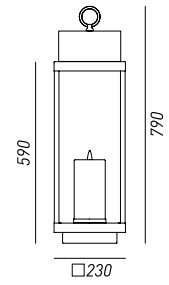

265.02.00  
265.02.FF  
1x Max 42W E27   
1x Max 20W E27   
IP 65

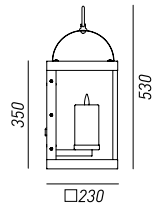

265.03.00  
265.03.FF  
1x Max 28W E27   
1x Max 12W E27   
IP 65

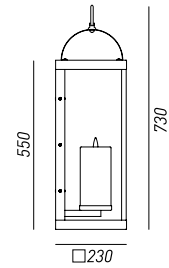

265.04.00  
265.04.FF  
1x Max 42W E27   
1x Max 20W E27   
IP 65

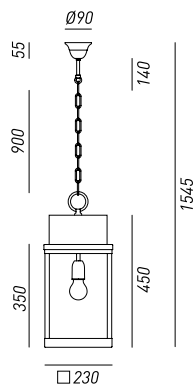

265.07.00  
265.07.FF  
1x Max 70W E27   
IP 44

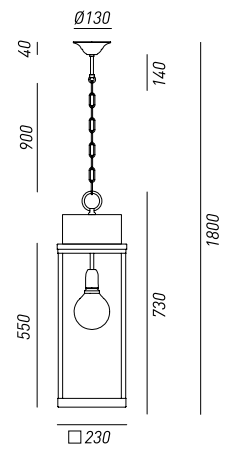

265.08.00  
265.08.FF  
1x Max 105W E27   
IP 44

Lampade / lamps

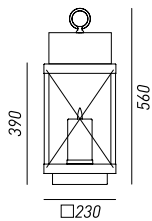

265.11.00  
265.11.FF  
1x Max 28W E27   
1x Max 12W E27   
IP 65

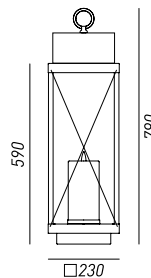

265.12.00  
265.12.FF  
1x Max 42W E27   
1x Max 20W E27   
IP 65

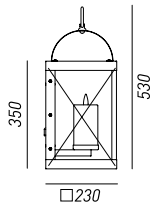

265.13.00  
265.13.FF  
1x Max 28W E27   
1x Max 12W E27   
IP 65

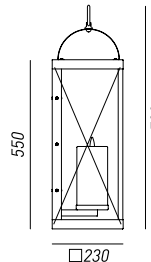

265.14.00  
265.14.FF  
1x Max 42W E27   
1x Max 20W E27   
IP 65

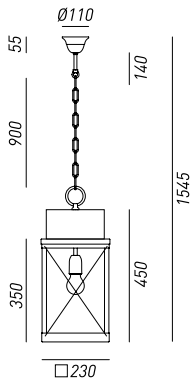

265.17.00  
265.17.FF  
1x Max 70W E27   
IP 44

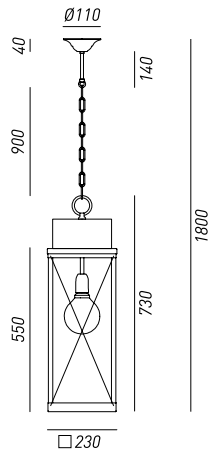

265.18.00  
265.18.FF  
1x Max 105W E27   
IP 44

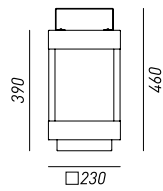

266.01.00  
266.01.FF  
1x 18W 2G10   
IP 65

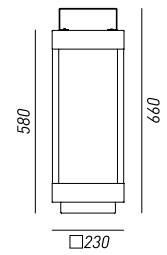

266.02.00  
266.02.FF  
1x 18W 2G10   
IP 65

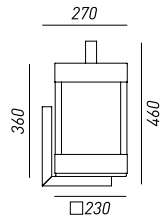

266.03.00  
266.03.FF  
1x 18W 2G10   
IP 65

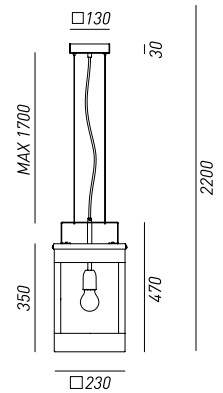

266.07.00  
266.07.FF  
1x Max 70W E27   
IP 44

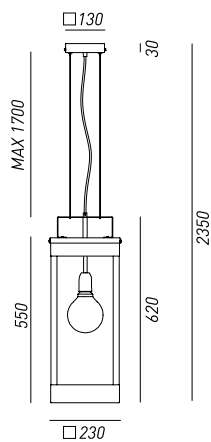

266.08.00  
266.08.FF  
1x Max 105W E27   
IP 44

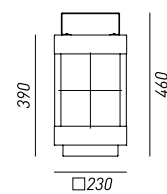

266.11.00  
266.11.FF  
1x 18W 2G10   
IP 65

Lampade / lamps

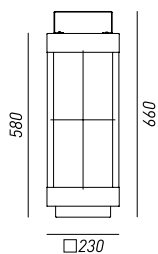

266.12.00  
266.12.FF  
1x 18W 2G10   
IP 65

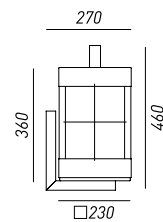

266.13.00  
266.13.FF  
1x 18W 2G10   
IP 65

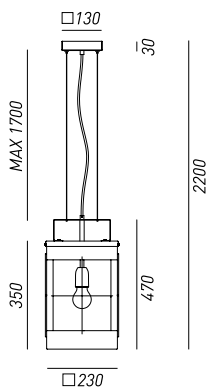

266.17.00  
266.17.FF  
1x Max 70W E27   
IP 44

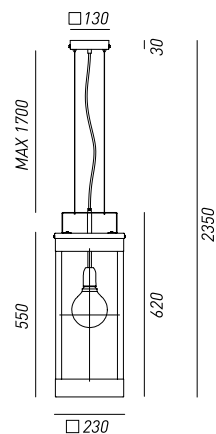

266.18.00  
266.18.FF  
1x Max 105W E27   
IP 44

optional



PICCHETTO / STAKE  
266.30.FZ  
□ 140 mm H 400 mm

*dettaglio rosoni / canopie's details*



265.08-18  
Ø 110 mm H 40 mm



266.07-08-17-18  
Ø 130 mm H 30 mm

*finiture montatura / frame finishes*



OTTONE  
BRASS



FERRO  
IRON

*vetro / glass*



VETRO TRASPARENTE  
TRANSPARENT GLASS

# QUADRO





CREATA SU MISURA PER UNA DELLE PIÙ SUGGESTIVE REALIZZAZIONI DE IL FANALE, LA COLLEZIONE QUADRO È ENTRATA POI A FAR PARTE DEL CATALOGO. L'ELEGANZA ASSOLUTA, LE FORME GEOMETRICHE INCONTAMINATE E I RIFERIMENTI IRLANDESI CARATTERIZZANO QUESTE LAMPADE PRODOTTE IN VETRO TRASPARENTE O PLEXIGLASS BIANCO E OTTONE ANTICATO.

THIS STRIKING COLLECTION STARTED OUT AS A SPECIAL MADE-TO-ORDER RANGE OF LAMPS, BUT IT IS NOW PART OF OUR CATALOGUE. THESE LAMPS, WHICH ARE ABSOLUTELY ELEGANT IN THEIR PRISTINE GEOMETRIC SHAPES, ARE MADE WITH BRASS FRAMES AND EITHER TRANSPARENT GLASS OR WHITE PLEXIGLASS.









Lampade / lamps

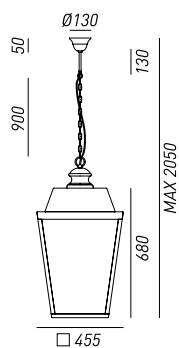

262.50.OB  
262.50.OT  
1x Max 116W E27   
IP 43

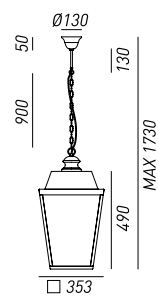

262.51.OB  
262.51.OT  
1x Max 77W E27   
IP 43

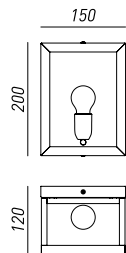

262.01.OT  
1x Max 30W E14   
IP 55

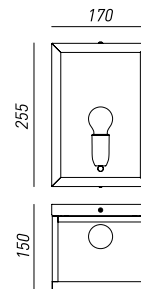

262.02.OT  
1x Max 46W E27   
IP 55

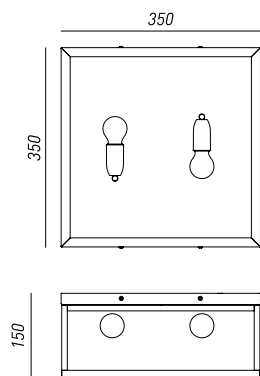

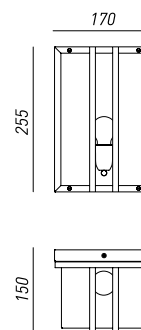

262.03.OT  
2x Max 30W E27   
IP 55

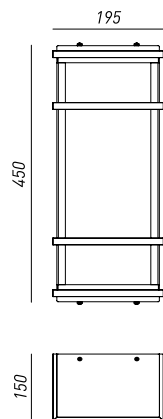

262.07.OT  
1x Max 46W E27   
IP 55

(vedi realizzazione pag. 464) / (see project on page 464)



**262.10.0B**  
 1x Max 42W GX 24q 3/4   
 Ballast included  
 IP 55 

*dettaglio rosoni / canopie's details*



**262.50-51**  
 Ø 130 mm H 55 mm

*finiture montatura / frame finishes*



**OTTONE**  
**BRASS**

*vetro / glass*



**VETRO TRASPARENTE**  
**TRANSPARENT GLASS**



**PLEXIGLASS BIANCO**  
**WHITE PLEXIGLASS**

**DECORI**





NATA DALLA FORTE ESIGENZA DI ESALTARE UN'ILLUMINAZIONE PROPRIAMENTE TECNICA, LA COLLEZIONE DECORI VALORIZZA L'ATTENTA RICERCA MATERICA. LE LAMPADE, DISPONIBILI IN FERRO O RAME, SONO CARATTERIZZATE DA UN'ESTREMA ESSENZIALITÀ DELLE LINEE GARANTENDO COMUNQUE UNA PERFETTA COESIONE TRA FUNZIONALITÀ E LATO ESTETICO.

CREATED FROM THE GREAT NEED FOR ENHANCEMENT OF PROPER ILLUMINATION TECHNIQUE, DECORI COLLECTION ENHANCES THE CAREFUL MATERIAL RESEARCH. THE LAMPS, AVAILABLE IN IRON OR COPPER, ARE CHARACTERIZED BY AN EXTREME SIMPLICITY OF THE LINES WHILE STILL PROVIDING A PERFECT COHESION BETWEEN FUNCTIONALITY AND AESTHETICS.













*lampade / lamps*

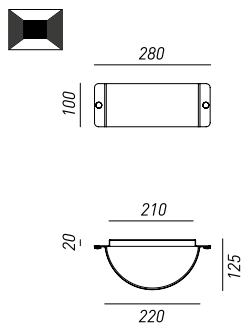

252.01.RR  
252.01.RF  
1x Max 46W E27   
252.51.RR  
252.51.RF  
LED 8,5W 3000K  
IP 54

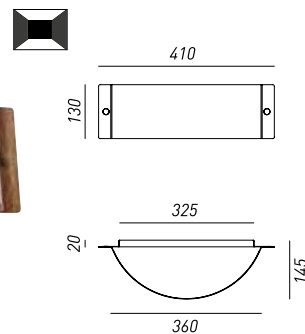

252.02.RR  
252.02.RF  
2x Max 30W E27   
252.52.RR  
252.52.RF  
LED 13W 3000K  
IP 54

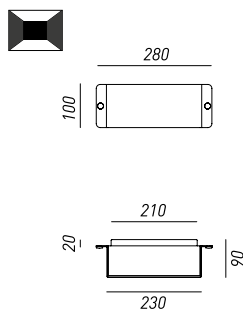

252.03.RR  
252.03.RF  
1x Max 46W E27   
252.53.RR  
252.53.RF  
LED 8,5W 3000K  
IP 54

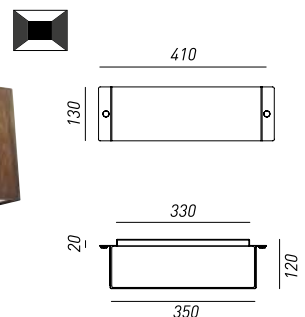

252.04.RR  
252.04.RF  
2x Max 30W E27   
252.54.RR  
252.54.RF  
LED 13W 3000K  
IP 54

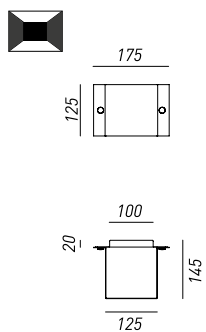

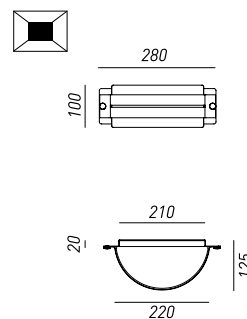

252.05.RR  
252.05.RF  
1x Max 33W G9   
252.55.RR  
252.55.RF  
LED 7,5W 3000K  
IP 54



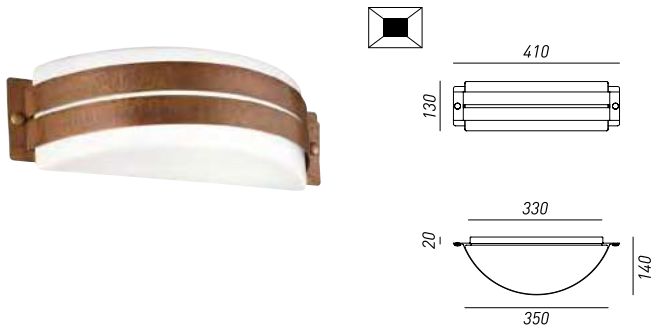

252.06.RR  
252.06.RF  
1x Max 46W E27   
252.56.RR  
252.56.RF  
LED 8,5W 3000K  
IP 54







252.07.RR  
252.07.RF  
2x Max 30W E27   
252.57.RR  
252.57.RF  
LED 13W 3000K  
IP 54 

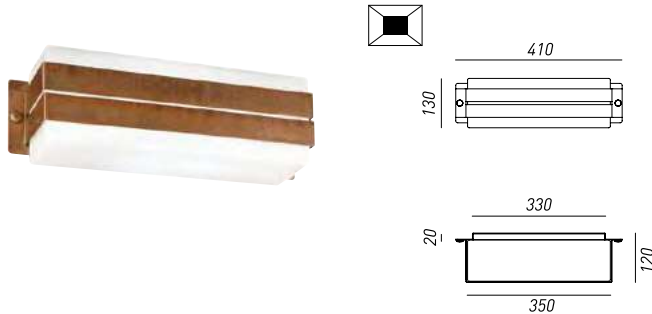

252.08.RR  
252.08.RF  
1x Max 46W E27   
252.58.RR  
252.58.RF  
LED 8,5W 3000K  
IP 54 



252.09.RR   
252.09.RF  
2x Max 30W E27  
252.59.RR  
252.59.RF  
LED 13W 3000K  
IP 54 

legenda simboli / symbols key

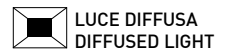
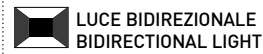

finiture fascia / band finishes



vetro / glass



**BORGO**





ARTIGIANALITÀ E ATTENTA RICERCA DEI MATERIALI SI FONDONO CON LE PIÙ RECENTI TECNICHE D'ILLUMINAZIONE DANDO VITA ALLA COLLEZIONE BORG0 CHE SI CONFIGURA COME LA PIÙ ALTA RAPPRESENTAZIONE DEL MOOD AZIENDALE. LE LAMPADE, REALIZZATE IN RAME ED OTTONE, PRESENTANO FORME D'ISPIRAZIONE CLASSICA SAPIENTEMENTE RIVISITATE IN CHIAVE CONTEMPORANEA.

CRAFTMANSHIP AND CAREFUL RESEARCH OF THE MATERIALS, COMBINED WITH THE LATEST ILLUMINATION TECHNIQUES, MAKE THE BORG0 COLLECTION AS THE HIGHEST REPRESENTATION OF THE COMPANY'S MOOD. THE LAMPS, MADE OF COPPER AND BRASS, ARE FORMS OF CLASSICAL INSPIRATION WISELY REVISITED IN A CONTEMPORARY WAY.









lampade / lamps

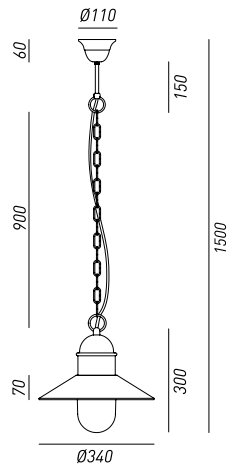

244.08.ORB  
244.08.ORT  
1x Max 116W E27   
1x Max 30W E27   
IP 44

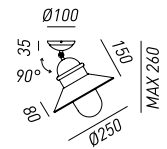

244.02.ORB  
244.02.ORT  
1x Max 57W E27   
1x Max 23W E27   
IP 43

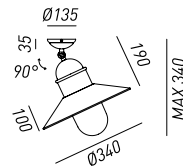

244.03.ORB  
244.03.ORT  
1x Max 116W E27   
1x Max 30W E27   
IP 43

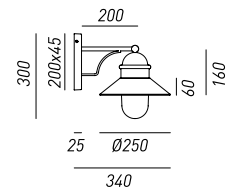

244.05.ORB  
244.05.ORT  
1x Max 57W E27   
1x Max 23W E27   
IP 44

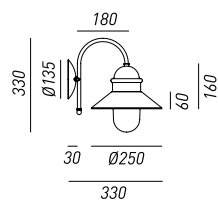

244.06.ORB  
244.06.ORT  
1x Max 57W E27   
1x Max 23W E27   
IP 44

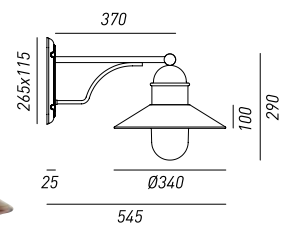

244.25.ORB  
244.25.ORT  
1x Max 116W E27   
1x Max 30W E27   
IP 44

pali / lamp posts

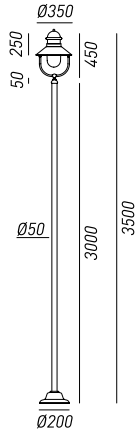

244.30.ORB  
244.30.ORT  
1x Max 116W E27   
1x Max 30W E27   
IP 44

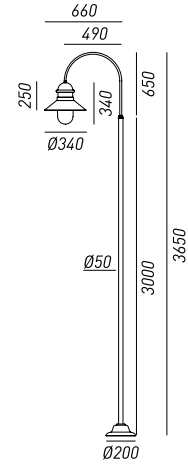

244.40.ORB  
244.40.ORT  
1x Max 116W E27   
1x Max 30W E27   
IP 44

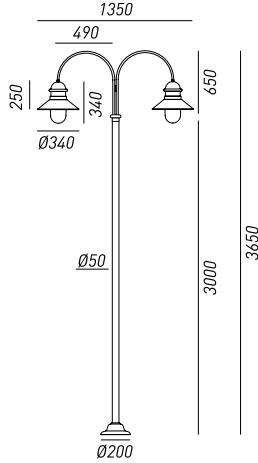

244.42.ORB  
244.42.ORT  
2x Max 116W E27   
2x Max 30W E27   
IP 44

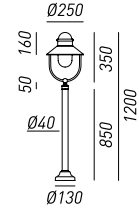

301.B2.ORB  
301.B2.ORT  
1x Max 57W E27   
1x Max 23W E27   
IP 44

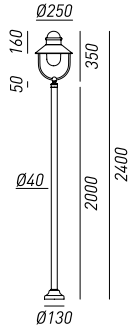

301.B4.ORB  
301.B4.ORT  
1x Max 57W E27   
1x Max 23W E27   
IP 44

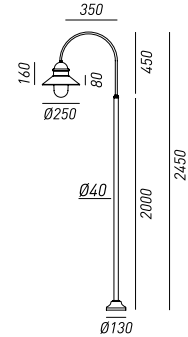

301.D3.ORB  
301.D3.ORT  
1x Max 57W E27   
1x Max 23W E27   
IP 44

pali / lamp posts

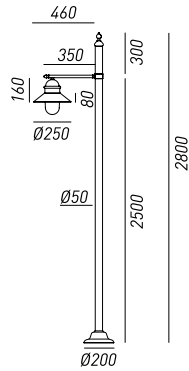

304.H3.ORB  
 304.H3.ORT  
 1x Max 57W E27   
 1x Max 23W E27   
 IP 44

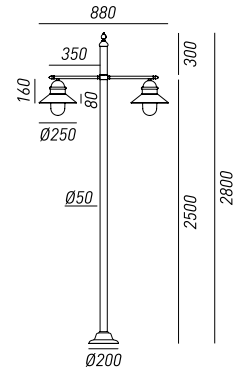

304.L3.ORB  
 304.L3.ORT  
 2x Max 57W E27   
 2x Max 23W E27   
 IP 44

dettaglio rosoni / canopie's details



244.08-09  
 Ø 110 mm H 60 mm

finiture montatura / frame finishes



OTTONE  
 BRASS

finiture testa / shade finishes



OTTONE  
 BRASS



RAME  
 COPPER

vetro / glass



VETRO BIANCO  
 WHITE GLASS



VETRO TRASPARENTE  
 TRANSPARENT GLASS

**CALMAGGIORE**



L'IMPATTO VISIVO DELICATO  
MA DECISO CARATTERIZZA LE  
LAMPADINE DI QUESTA COLLEZIONE,  
DESTINATE AGLI AMBIENTI  
OUTDOOR. I PRODOTTI, REALIZZATI  
IN RAME E OTTONE ANTICATO, SONO  
CONTRADDISTINTI DA UN'EFFICIENTE  
EMISSIONE LUMINOSA CHE  
CONFERISCE CARATTERE AGLI SPAZI  
ARREDATI.

THIS OUTDOOR COLLECTION OF  
LAMPS OFFERS A FIRM YET DELICATE  
VISUAL IMPACT. THE LAMPS,  
WHICH ARE MADE OF COPPER  
AND ANTIQUED BRASS, GIVE OFF  
EFFICIENT LIGHT WHILE ADDING  
CHARACTER TO THE FURNISHED  
SPACE.









*lampade / lamps*



**233.03.ORB**  
**233.03.ORT**  
 1x Max 46W E27   
 1x Max 20W E27   
 IP 44

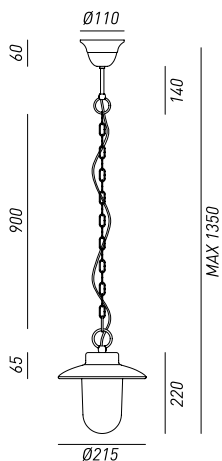

**231.03.ORB**  
**231.03.ORT**  
 1x Max 46W E27   
 1x Max 20W E27   
 IP 44

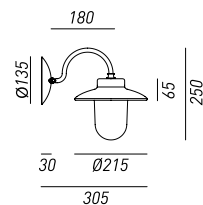

**230.03.ORB**  
**230.03.ORT**  
 1x Max 46W E27   
 1x Max 20W E27   
 IP 44

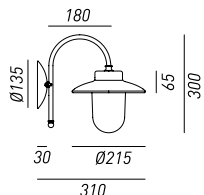

**232.06.ORB**  
**232.06.ORT**  
 1x Max 46W E27   
 1x Max 20W E27   
 IP 43

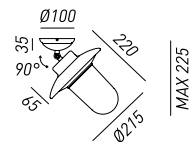

*pali / lamp posts*



**304.H1.ORB**  
**304.H1.ORT**  
 1x Max 57W E27   
 1x Max 23W E27   
 IP 44

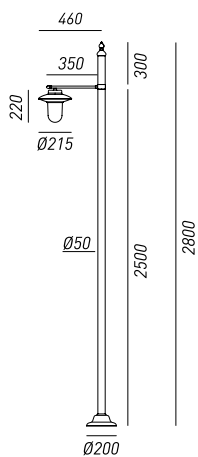

**304.L1.ORB**  
**304.L1.ORT**  
 2x Max 57W E27   
 2x Max 23W E27   
 IP 44

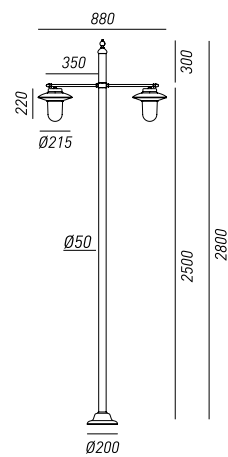

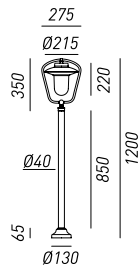

301.B3.ORB  
301.B3.ORT  
1x Max 57W E27   
1x Max 23W E27   
IP 44

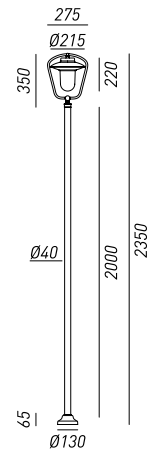

301.B5.ORB  
301.B5.ORT  
1x Max 57W E27   
1x Max 23W E27   
IP 44

dettaglio rosoni / canopie's details



233.03  
Ø 110 mm H 60 mm

finiture montatura / frame finishes



OTTONE  
BRASS

finiture testa / shade finishes



RAME  
COPPER

vetro / glass



VETRO BIANCO  
WHITE GLASS



VETRO TRASPARENTE  
TRANSPARENT GLASS

**PATIO**





LAMPADRE DA ESTERNO  
CARATTERIZZATE DAL DESIGN SOBRIO  
ED ESSENZIALE REALIZZATE IN  
RAME E OTTONE ANTICATO. GRAZIE  
ALL'ASPETTO E ALLA RICERCATA  
LAVORAZIONE, I PRODOTTI DI QUESTA  
COLLEZIONE SI CONFIGURANO COME  
ELEMENTI DECORATIVI DALL'ALTA  
FUNZIONALITÀ TECNICA.

THESE OUTDOOR LAMPS ARE  
DISTINGUISHED BY A SIMPLE  
DESIGN AND ARE MADE OF  
COPPER AND ANTIQUED BRASS.  
THANKS TO THEIR LOOK AND  
REFINED MANUFACTURING, THESE  
LAMPS STAND OUT AS HIGH-  
TECH, FUNCTIONING DECORATIVE  
ELEMENTS.











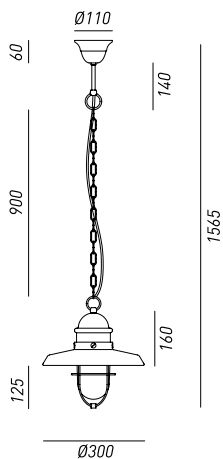





*lampade / lamps*

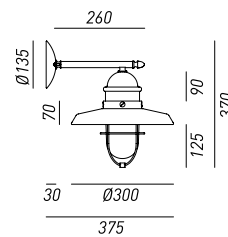



225.07.ORB  
225.07.ORT  
1x Max 57W E27   
1x Max 23W E27    
IP 44 

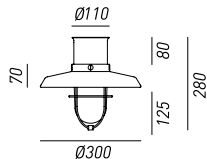

225.05.ORB  
225.05.ORT  
1x Max 57W E27   
1x Max 23W E27    
IP 44 



225.04.ORB  
225.04.ORT  
1x Max 57W E27   
1x Max 23W E27    
IP 43

*dettaglio rosoni / canopies details*



225.07  
Ø 110 mm H 60 mm

---

*finiture montatura / frame finishes*



**OTTONE  
BRASS**

---

*finiture testa / shade finishes*



**OTTONE  
BRASS**



**RAME  
COPPER**

---

*vetro / glass*



**VETRO BIANCO  
WHITE GLASS**



**VETRO TRASPARENTE  
TRANSPARENT GLASS**

---

**GRANAIO**



NATA DALLA FORTE ESIGENZA DI  
ESALTARE UN'ILLUMINAZIONE  
PROPRIAMENTE TECNICA, LA  
COLLEZIONE DECORI VALORIZZA  
L'ATTENTA RICERCA MATERICA. LE  
LAMPADIE, DISPONIBILI IN OTTONE  
E RAME, SONO CARATTERIZZATE DA  
UN'ESTREMA ESSENZIALITÀ DELLE  
LINEE GARANTENDO COMUNQUE  
UNA PERFETTA COESIONE TRA  
FUNZIONALITÀ E LATO ESTETICO.

CREATED FROM THE GREAT NEED  
FOR ENHANCEMENT OF PROPER  
ILLUMINATION TECHNIQUE, DECORI  
COLLECTION ENHANCES THE  
CAREFUL MATERIAL RESEARCH. THE  
LAMPS, AVAILABLE IN BRASS AND  
COPPER, ARE CHARACTERIZED BY AN  
EXTREME SIMPLICITY OF THE LINES  
WHILE STILL PROVIDING A PERFECT  
COHESION BETWEEN FUNCTIONALITY  
AND AESTHETICS.









*lampade / lamps*

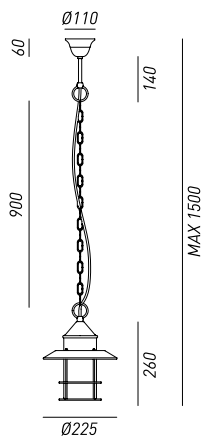

246.07.ORB  
246.07.ORT  
1x Max 57W E27   
1x Max 23W E27   
IP 44

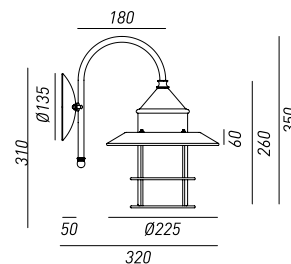

246.06.ORB  
246.06.ORT  
1x Max 57W E27   
1x Max 23W E27   
IP 44

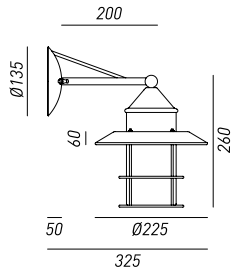

246.05.ORB  
246.05.ORT  
1x Max 57W E27   
1x Max 23W E27   
IP 44

*pali / lamp posts*

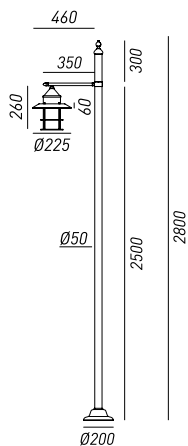

304.H8.ORB  
304.H8.ORT  
1x Max 57W E27   
1x Max 23W E27   
IP 44

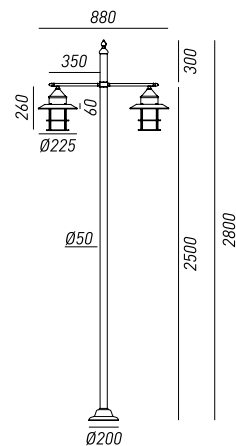

304.L8.ORB  
304.L8.ORT  
2x Max 57W E27   
2x Max 23W E27   
IP 44

*dettaglio rosoni / canopie's details*



246.07  
 Ø 110 mm H 60 mm

*finiture montatura / frame finishes*



OTTONE  
 BRASS

*finiture testa / shade finishes*



OTTONE  
 BRASS



RAME  
 COPPER

*vetro / glass*



VETRO BIANCO  
 WHITE GLASS



VETRO TRASPARENTE  
 CLEAR GLASS

**FIORDO**





LA COLLEZIONE FIORDO NASCE DALLA VOLONTÀ DI ADATTARE CARATTERISTICHE TIPICHE DEL DESIGN D'INTERNI A PRODOTTI DESTINATI ALL'OUTDOOR. LE LINEE ESTETICHE ISPIRATE AI PAESI SCANDINAVI, CONFERISCONO PERSONALITÀ A QUESTE LAMPADE, REALIZZATE IN OTTONE E RAME, CREANDO ATMOSFERE ACCOGLIENTI E FAMILIARI IN AMBIENTI ESTERNI.

THIS COLLECTION COMES FROM THE DESIRE TO ADAPT INTERIOR DESIGN PRODUCTS FEATURES IN OUTDOOR SURROUNDINGS ONES. THE AESTHETIC LINES INSPIRED BY THE SCANDINAVIAN COUNTRIES, GIVE PERSONALITY TO THESE LAMPS, MADE OF BRASS AND COPPER, CREATING A WELCOMING AND FAMILIAR ATMOSPHERE FOR THE OUTDOORS ENVIRONMENT.









*lampade / lamps*

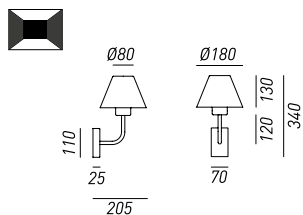

**261.01.OR**  
1x Max 48W G9

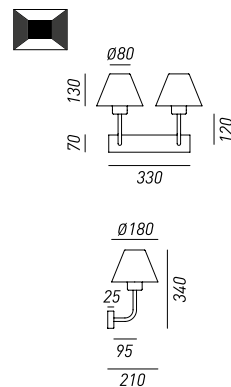

**261.02.OR**  
2x Max 48W G9

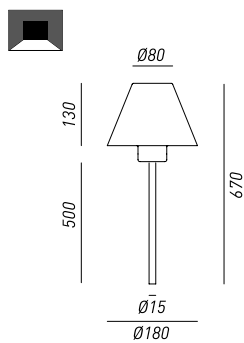

**261.10.OR**  
1x Max 48W G9

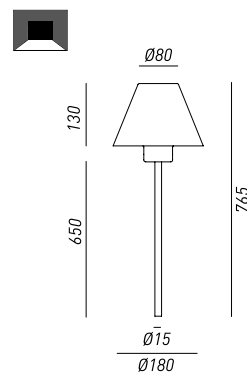

**261.11.OR**  
1x Max 48W G9

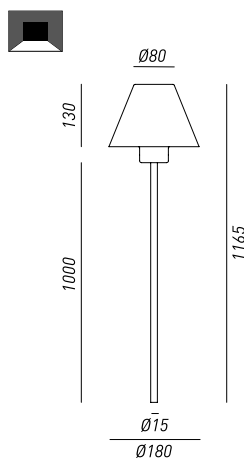
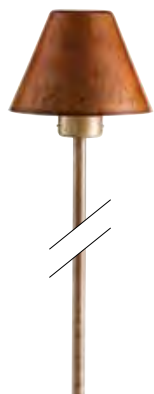

**261.12.OR**  
1x Max 48W G9

*legenda simboli / symbols key*

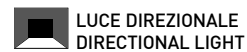
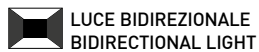

*optional*



**PICCHETTO / STAKE**  
260.30.FZ  
Ø 95 mm H 250 mm

*finiture montatura / frame finishes*



**OTTONE**  
**BRASS**

*finiture testa / shade finishes*



**RAME**  
**COPPER**

*vetro / glass*



**VETRO BIANCO**  
**WHITE GLASS**

**VENEZIA**





UN TRIBUTO ALLA CITTÀ DI VENEZIA, DALLA QUALE QUESTA COLLEZIONE PRENDE IL NOME. GUSTO CLASSICO E DISEGNO ELEGANTE CARATTERIZZANO QUESTE LAMPADE DA ESTERNI REALIZZATE IN OTTONE, RAME ANTICATO E VETRO BIANCO O PULEGOSO, TECNICA, QUEST'ULTIMA, CHE CONFERISCE NOTEVOLI EFFETTI CROMATICI.

THIS COLLECTION IS NAMED AS A TRIBUTE TO THE CITY OF VENICE. THESE OUTDOOR LAMPS ARE CLASSICALLY AND ELEGANTLY DESIGNED AND MADE OF BRASS, ANTIQUED COPPER WITH EITHER WHITE OR "PULEGOSO" GLASS TECHNIQUE, THE LATTER GIVING OFF PECULIAR CHROMATIC EFFECTS.















lampade / lamps

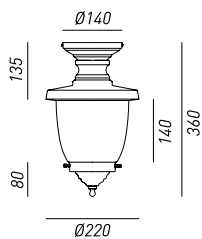

248.02.ORB  
248.02.ORT  
1x Max 57W E27   
1x Max 23W E27   
IP 44

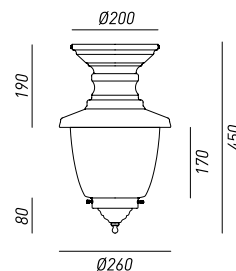

248.03.ORB  
248.03.ORT  
1x Max 57W E27   
1x Max 30W E27   
IP 44

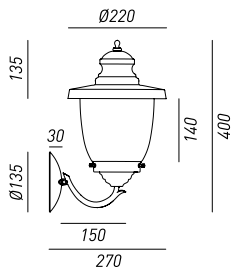

248.05.ORB  
248.05.ORT  
1x Max 57W E27   
1x Max 23W E27   
IP 44

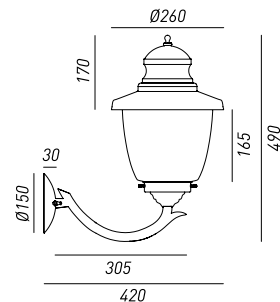

248.06.ORB  
248.06.ORT  
1x Max 57W E27   
1x Max 30W E27   
IP 44

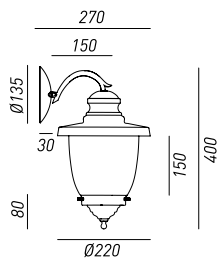

248.09.ORB  
248.09.ORT  
1x Max 57W E27   
1x Max 23W E27   
IP 44

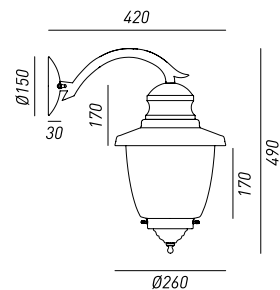

248.10.ORB  
248.10.ORT  
1x Max 57W E27   
1x Max 30W E27   
IP 44

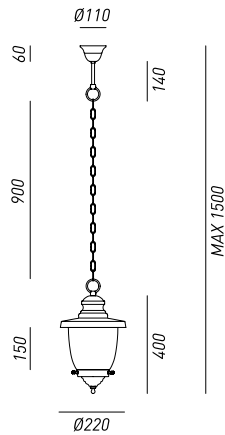

248.07.ORB  
248.07.ORT  
1x Max 57W E27   
1x Max 23W E27   
IP 44

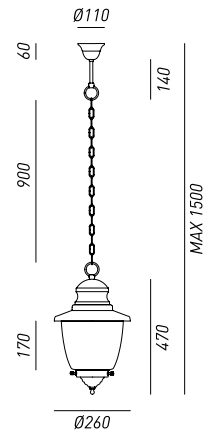

248.08.ORB  
248.08.ORT  
1x Max 57W E27   
1x Max 30W E27   
IP 44

pali / lamp posts

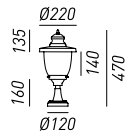

248.11.ORB  
248.11.ORT  
1x Max 57W E27   
1x Max 23W E27   
IP 44

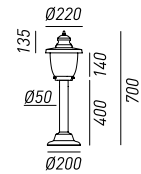

248.12.ORB  
248.12.ORT  
1x Max 57W E27   
1x Max 23W E27   
IP 44

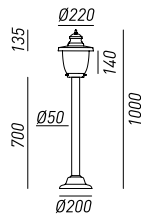

248.13.ORB  
248.13.ORT  
1x Max 57W E27   
1x Max 23W E27   
IP 44

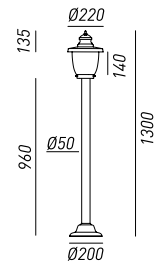

248.14.ORB  
248.14.ORT  
1x Max 57W E27   
1x Max 23W E27   
IP 44

pali / lamp posts

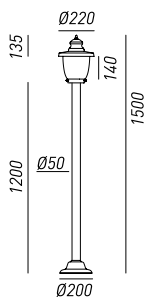
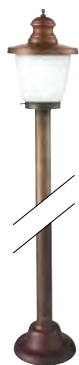

248.15.ORB  
248.15.ORT  
1x Max 57W E27   
1x Max 23W E27   
IP 44

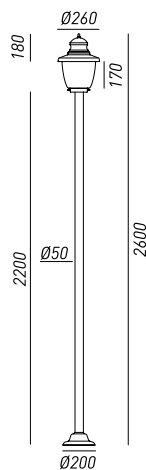

248.18.ORB  
248.18.ORT  
1x Max 77W E27   
1x Max 30W E27   
IP 44

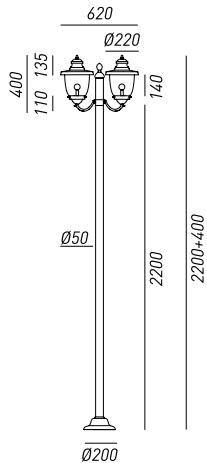

248.20.ORB  
248.20.ORT  
2x Max 57W E27   
2x Max 23W E27   
IP 44

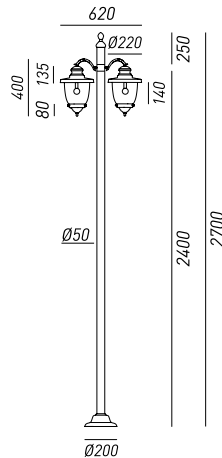

248.27.ORB  
248.27.ORT  
2x Max 57W E27   
2x Max 23W E27   
IP 44

dettaglio rosoni / canopie's details



248.07-08  
 $\varnothing 110$  mm H 60 mm



---

*finiture montatura / frame finishes*



**OTTONE**  
**BRASS**

---

*finiture testa / shade finishes*



**RAME**  
**COPPER**

---

*vetro / glass*



**VETRO BIANCO**  
**WHITE GLASS**



**VETRO PULEGOSO**  
**BUBBLE GLASS**

---

**LOGGIA**



LAMPADE DALLA FORMA  
CILINDRICA EVOCAO SUGGESTIVE  
ATMOSFERE ATTRAVERSO  
UNA REINTERPRETAZIONE IN  
CHIAVE MODERNA DEI CLASSICI  
PORTACANDELE A MURO.  
REALIZZATA IN VETRO BIANCO O  
PULEGOSO E OTTONE ANTICATO  
LA COLLEZIONE È COMPOSTA DA  
APPLIQUE, SOSPENSIONI E LAMPADE  
DA TERRA.

THESE CYLINDRICAL SHAPED LAMPS  
ARE A MODERN INTERPRETATION  
OF THE CLASSIC WALL MOUNTED  
CANDLESTICK. MADE IN ANTIQUED  
BRASS WITH EITHER WHITE OR  
"PULEGOSO" GLASS TECHNIQUE,  
THIS COLLECTION INCLUDES WALL  
MOUNTED, SUSPENSION AND FLOOR  
LAMPS.







Lampade / lamps

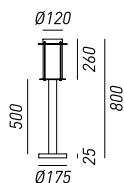

264.10.00T  
264.10.00B  
1x Max 46W E27   
1x Max 20W E27   
IP 44

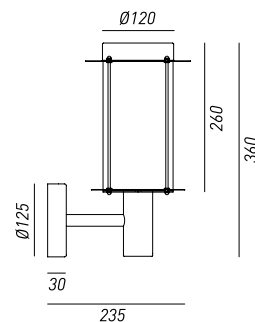

264.01.00T  
264.01.00B  
1x Max 46W E27   
1x Max 20W E27   
IP 44

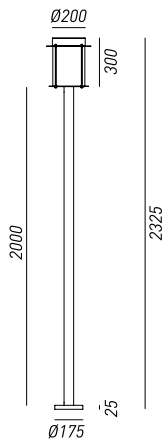
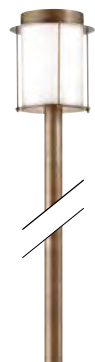

264.14.00T  
264.14.00B  
1x Max 57W E27   
1x Max 30W E27   
IP 44

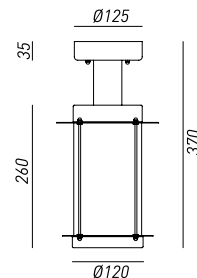

264.02.00T  
264.02.00B  
1x Max 46W E27   
1x Max 20W E27   
IP 44

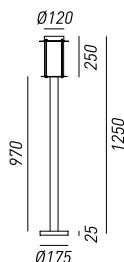

264.11.00T  
264.11.00B  
1x Max 46W E27   
1x Max 20W E27   
IP 44

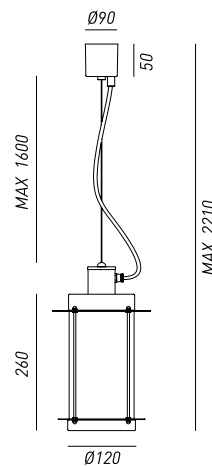

264.07.00T  
264.07.00B  
1x Max 46W E27   
1x Max 20W E27   
IP 44



*dettaglio rosoni / canopie's details*



244.07  
L 90 mm H 50 mm

*finiture montatura / frame finishes*



OTTONE  
BRASS

*finiture testa / shade finishes*



OTTONE  
BRASS

*vetro / glass*



VETRO BIANCO  
WHITE GLASS



VETRO PULEGOSO  
BUBBLE GLASS

**GARDEN**





COLLEZIONE DAL DESIGN  
ESSENZIALE E CONTEMPORANEO  
REALIZZATA IN OTTONE E RAME  
ANTICATO. GRAZIE ALLE SUE  
CARATTERISTICHE ESTETICHE E  
FUNZIONALI QUESTE LAMPADE  
ARREDANO GLI AMBIENTI ESTERNI  
OTTENENDO UN IMPATTO VISIVO  
SOBRIO ED ELEGANTE.

THIS SIMPLY DESIGNED AND  
CONTEMPORARY COLLECTION IS  
MADE OF BRASS AND ANTIQUED  
COPPER. THANKS TO ITS  
FUNCTIONAL AND APPEALING  
FEATURES, THE GARDEN  
COLLECTION IS ABLE TO DECORATE  
THE OUTSIDE SETTING GIVING OFF  
A MODEST AND ELEGANT VISUAL  
IMPACT.

Lampade / lamps

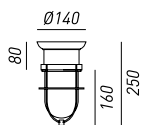

245.50.ORB  
245.50.ORT  
1x Max 57W E27   
1x Max 23W E27   
IP 43

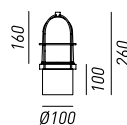

245.51.ORB  
245.51.ORT  
1x Max 57W E27   
1x Max 23W E27   
IP 44

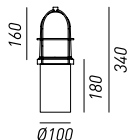

245.52.ORB  
245.52.ORT  
1x Max 57W E27   
1x Max 23W E27   
IP 44

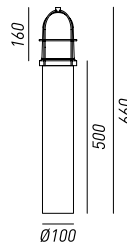

245.53.ORB  
245.53.ORT  
1x Max 57W E27   
1x Max 23W E27   
IP 44

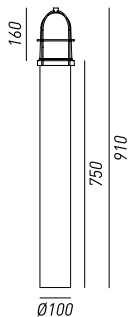



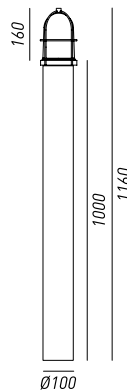

245.54.ORB  
245.54.ORT  
1x Max 57W E27   
1x Max 23W E27   
IP 44

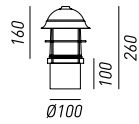





245.55.ORB  
245.55.ORT  
1x Max 57W E27   
1x Max 23W E27   
IP 44

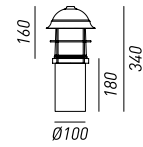





245.41.ORB  
245.41.ORT  
1x Max 57W E27   
1x Max 23W E27    
IP 44 

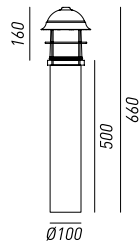





245.42.ORB  
245.42.ORT  
1x Max 57W E27   
1x Max 23W E27    
IP 44 

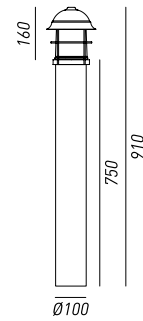





245.43.ORB  
245.43.ORT  
1x Max 57W E27   
1x Max 23W E27    
IP 44 

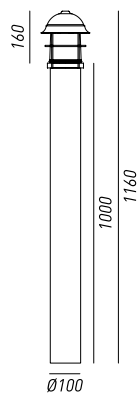



245.44.ORB  
245.44.ORT  
1x Max 57W E27   
1x Max 23W E27    
IP 44 

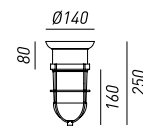

245.45.ORB  
245.45.ORT  
1x Max 57W E27   
1x Max 23W E27    
IP 44 



245.20.ORB  
245.20.ORT  
1x Max 57W E27   
1x Max 23W E27    
IP 43

Lampade / lamps

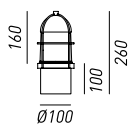

245.21.ORB  
245.21.ORT  
1x Max 57W E27   
1x Max 23W E27   
IP 44

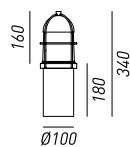

245.22.ORB  
245.22.ORT  
1x Max 57W E27   
1x Max 23W E27   
IP 44

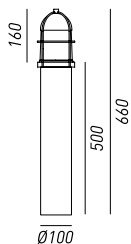

245.23.ORB  
245.23.ORT  
1x Max 57W E27   
1x Max 23W E27   
IP 44

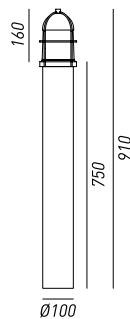

245.24.ORB  
245.24.ORT  
1x Max 57W E27   
1x Max 23W E27   
IP 44

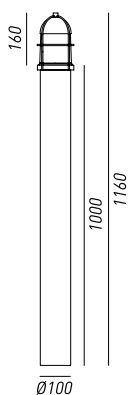

245.25.ORB  
245.25.ORT  
1x Max 57W E27   
1x Max 23W E27   
IP 44

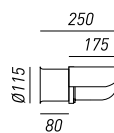

245.07.ORB  
245.07.ORT  
1x Max 46W E27   
1x Max 23W E27   
IP 44



*optional*



**PICCHETTO / STAKE**  
300.09.FZ  
Ø 110 H 400 mm



**COPRIBASE / BASE COVER**  
300.06.RR  
Ø 140 H 30 mm

*finiture montatura / frame finishes*



**OTTONE**  
BRASS

*finiture testa / shade finishes*



**OTTONE**  
BRASS



**RAME**  
COPPER

*vetro / glass*



**VETRO BIANCO**  
WHITE GLASS



**VETRO TRASPARENTE**  
TRANSPARENT GLASS

**PORTO**



LA LUCE SOFFUSA MA DECISA  
E IL DISEGNO MODERNO  
CARATTERIZZANO LA COLLEZIONE  
PORTO. L'ATTENTA LAVORAZIONE  
ASSICURA UN ELEVATO STANDARD  
QUALITATIVO A QUESTE LAMPADE DA  
ESTERNO IN GRADO DI CONIUGARE  
PERFETTAMENTE FUNZIONALITÀ ED  
ESTETICA.

PORTO IS CHARACTERIZED BY A  
SOFT BUT FIRM LIGHT, AS WELL AS  
A MODERN DESIGN. THE CAREFUL  
WORKMANSHIP ENSURES A HIGH  
STANDARD OF QUALITY FOR  
THESE OUTDOOR LAMPS, WHICH  
PERFECTLY COMBINE BEAUTY AND  
FUNCTIONALITY.







lampade / lamps

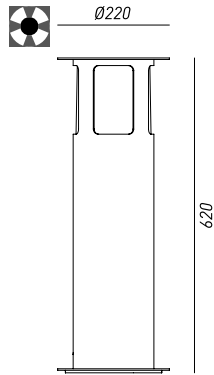

258.02.FF  
 1x Max 57W E27   
 1x Max 22W E27   
 258.22.FF  
 POWER LED 8,7W 3000K  
 IP 65

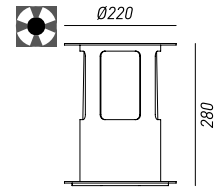

258.01.FF  
 1x Max 57W E27   
 1x Max 22W E27   
 258.21.FF  
 POWER LED 8,7W 3000K  
 IP 65

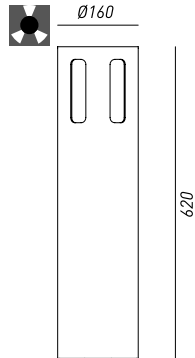

259.02.FF  
 1x Max 57W E27   
 1x Max 22W E27   
 259.22.FF  
 POWER LED 8,7W 3000K  
 IP 65

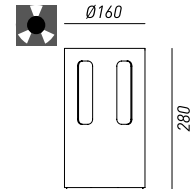

259.01.FF  
 1x Max 57W E27   
 1x Max 22W E27   
 259.21.FF  
 POWER LED 8,7W 3000K  
 IP 65

legenda simboli / symbols key

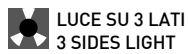
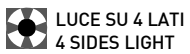

finiture montatura / frame finishes



vetro / glass



**MARINA**







NATA DALLA VOLONTÀ DI SODDISFARE ESIGENZE PROPRIAMENTE TECNICHE, QUESTA COLLEZIONE SI COMPONE DI LAMPADE DALL'ASPETTO EQUILIBRATO REALIZZATE IN OTTONE ANTICATO. IL DESIGN EVIDENTEMENTE ISPIRATO ALLO STILE MARINA, RAPPRESENTA IL LEITMOTIV CHE CARATTERIZZA OGNI SINGOLA REALIZZAZIONE.

THE DESIRE TO MEET PURELY TECHNICAL NEEDS STANDS BEHIND THIS COLLECTION OF LAMPS, MADE OF ANTIQUED BRASS. THEIR BALANCED DESIGN IS CLEARLY INSPIRED BY THE MARINA STYLE, WHOSE MOTIFS ARE REPRESENTED IN EVERY SINGLE PIECE.

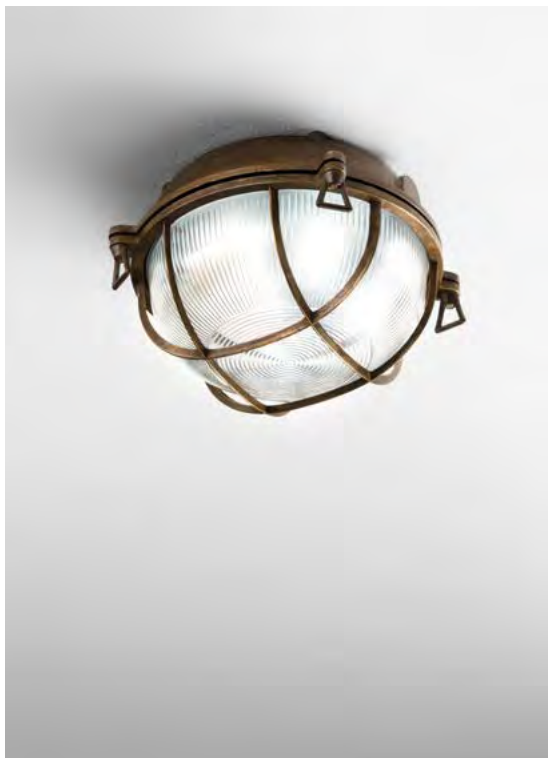





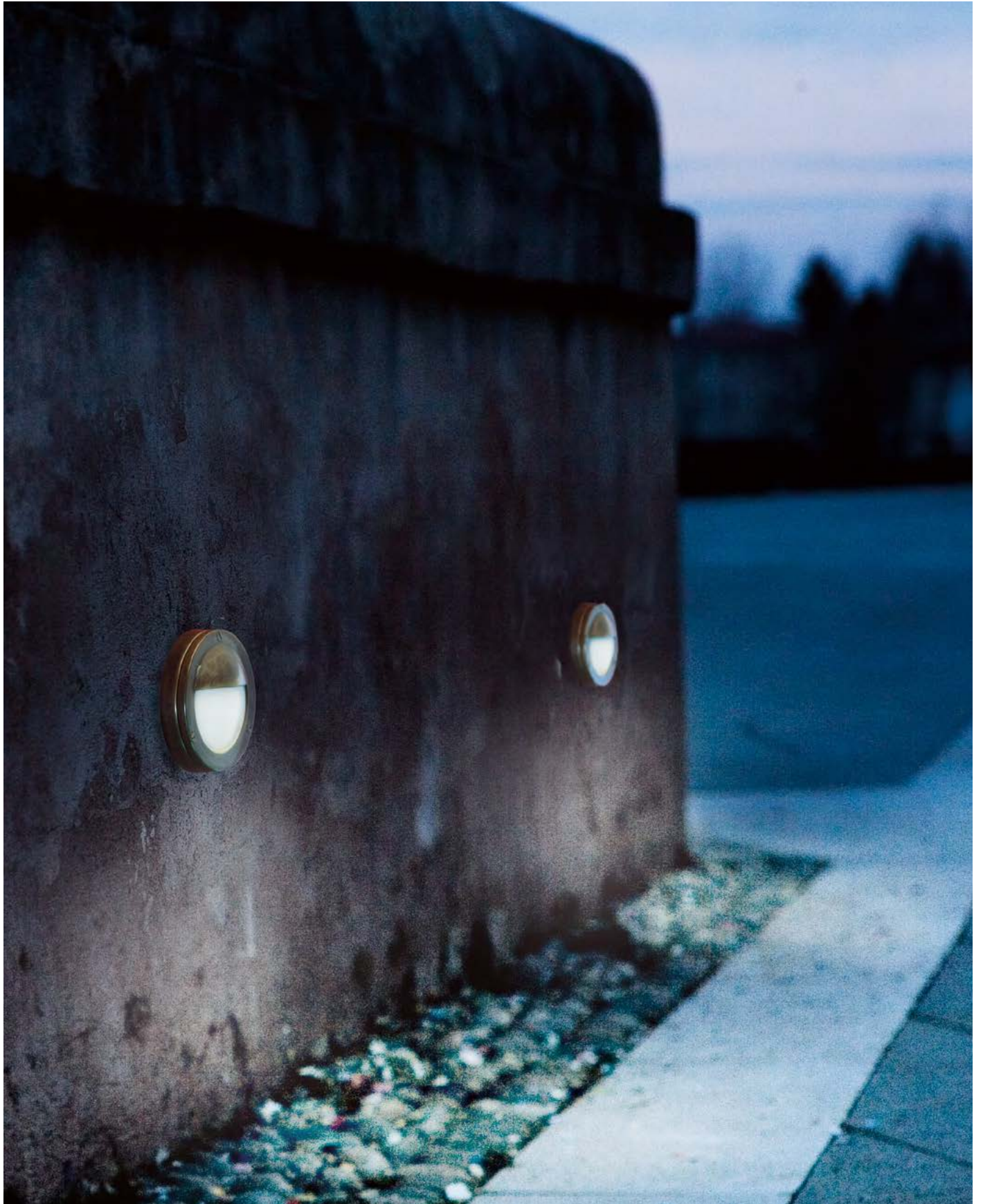

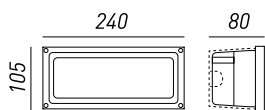

lampade / lamps



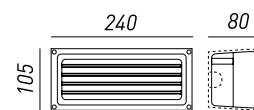

247.44.A0  
LED 13W 3000K  
247.25.A0  
1x Max 46W E27   
IP 65 



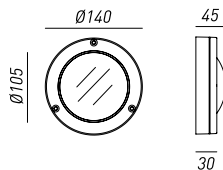

247.45.A0  
LED 13W 3000K  
247.26.A0  
1x Max 30W E27   
IP 65 



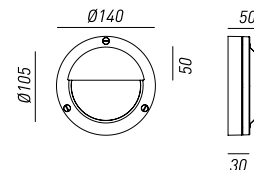

247.31.00  
LED 7W 3000K  
247.01.00  
1x Max 25W G9   
247.21.00  
1x Max 6W Gx53  POLYCARBONATE  
IP 55 



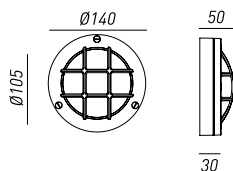

247.32.00  
LED 7W 3000K  
247.02.00  
1x Max 25W G9   
247.22.00  
1x Max 6W Gx53  POLYCARBONATE  
IP 55 

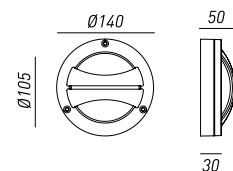

247.33.00  
LED 7W 3000K  
247.03.00  
1x Max 25W G9   
247.23.00  
1x Max 6W Gx53  POLYCARBONATE  
IP 55 



247.34.00  
LED 7W 3000K  
247.04.00  
1x Max 25W G9   
247.24.00  
1x Max 6W Gx53  POLYCARBONATE  
IP 55 

Lampade / lamps

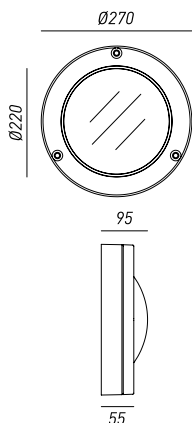

247.61.00  
POLYCARBONATE  
LED 13W 3000K  
IP 55 ▲ ▲

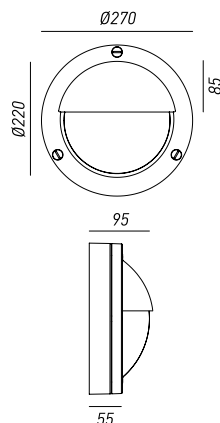

247.62.00  
POLYCARBONATE  
LED 13W 3000K  
IP 55 ▲ ▲

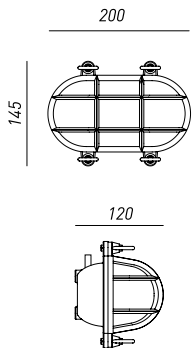

247.46.00  
LED 8,7W 3000K  
247.36.00  
1x Max 46W E27   
1x Max 11W E27   
IP 54 ▲

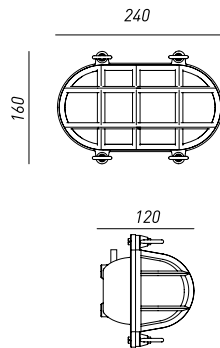

247.47.00  
LED 13W 3000K  
247.37.00  
1x Max 77W E27   
1x Max 23W E27   
IP 54 ▲

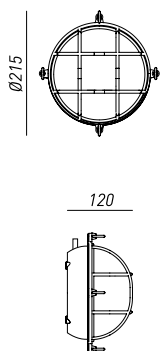

247.48.00  
LED 8,7W 3000K  
247.38.00  
1x Max 57W E27   
1x Max 15W E27   
IP 54 ▲

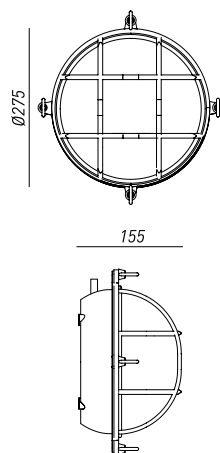

247.49.00  
LED 13W 3000K  
247.39.00  
1x Max 77W E27   
1x Max 23W E27   
IP 54 ▲



---

*finiture montatura / frame finishes*



FUSIONE OTTONE  
BRASS

---

*vetro / glass*

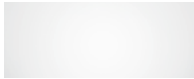

POLICARBONATO  
POLYCARBONATE



VETRO  
GLASS

---

**PONTE**





CARATTERIZZATE DALLA PRESENZA DI DUE PUNTI DI CONNESSIONE, QUESTE LAMPADE SONO IN GRADO DI RICREARE SUGGESTIVE ATMOSFERE RETRÒ GRAZIE ALLA FORZA VISIVA CHE LE CONTRADDISTINGUE. REALIZZATA IN OTTONE E RAME LA COLLEZIONE PONTE È CONCEPITA PER SODDISFARE ESIGENZE DI NATURA FUNZIONALE SENZA RINUNCIARE AL VALORE ESTETICO.

WITH THEIR TWO CONNECTING POINTS, THESE LAMPS RECREATE A SUGGESTIVE RETRO ATMOSPHERE THANKS TO THEIR VISUAL POWER. THE PONTE COLLECTION, MADE OF BRASS AND COPPER, IS DESIGNED TO SATISFY THE NEED FOR NATURAL FUNCTIONALITY WITHOUT SACRIFICING AESTHETICS.





Lampade / lamps

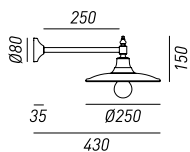

250.04.OR  
1x Max 77W E27   
IP 23

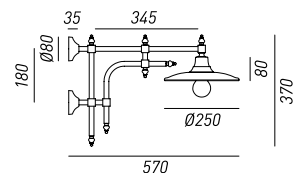

250.07.OR  
1x Max 77W E27   
IP 23

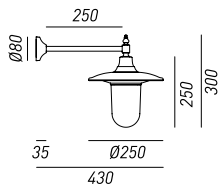

250.24.ORT  
250.24.ORB  
1x Max 57W E27   
1x Max 23W E27   
IP 44

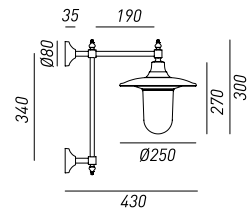

250.26.ORT  
250.26.ORB  
1x Max 57W E27   
1x Max 23W E27   
IP 44

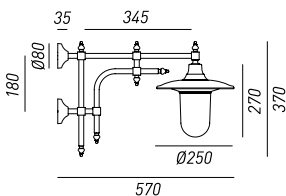

250.27.ORT  
250.27.ORB  
1x Max 57W E27   
1x Max 23W E27   
IP 44



---

*finiture montatura / frame finishes*



**OTTONE**  
**BRASS**

---

*finiture testa / shade finishes*



**RAME**  
**COPPER**

---

*vetro / glass*



**VETRO BIANCO**  
**WHITE GLASS**



**VETRO TRASPARENTE**  
**TRANSPARENT GLASS**

---

# SISTEMA CANALINE





LA MAESTRIA ARTIGIANA UNITA  
ALL'ESTREMA PERSONALIZZAZIONE  
TROVANO NEL SISTEMA CANALINE  
LA LORO MASSIMA ESPRESSIONE:  
LA MODULARITÀ TIPICA DI QUESTO  
SISTEMA, DISPONIBILE IN OTTONE  
E OTTONE NATURALE OFFRE  
MOLTEPLICI SOLUZIONI PER  
L'ILLUMINAZIONE DEGLI AMBIENTI.

CRAFTSMANSHIP AND  
CUSTOMIZATION ARE EMBODIED IN  
SISTEMA CANALINE: THIS LIGHTING  
SYSTEM, AVAILABLE BOTH IN BRASS  
AND NATURAL BRASS, THANKS TO  
ITS MODULARITY ALLOWS PLENTY OF  
LIGHTING SOLUTIONS.











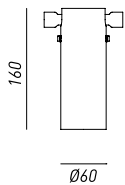

Lampade / lamps



214.04.FF  
214.04.ON  
214.04.OO  
1x Max 35W GU10 

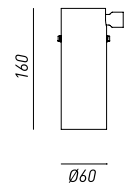

214.14.FF  
214.14.ON  
214.14.OO  
1x Max 35W GU10 

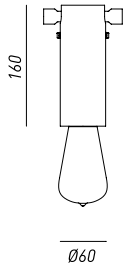

214.03.FF  
214.03.ON  
214.03.OO  
1x Max 57W E27 

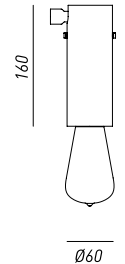

214.13.FF  
214.13.ON  
214.13.OO  
1x Max 57W E27 

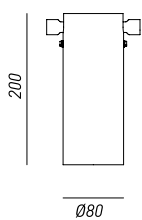

214.02.FF  
214.02.ON  
214.02.OO  
1x Max 50W E27 PAR20 

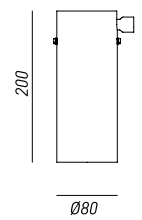

214.12.FF  
214.12.ON  
214.12.OO  
1x Max 50W E27 PAR20 

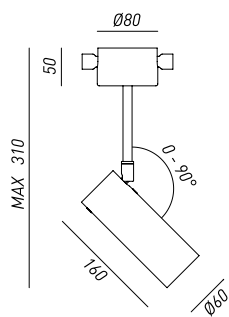

214.07.FF  
214.07.ON  
214.07.OO  
1x Max 35W GU10

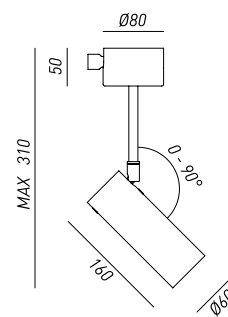

214.17.FF  
214.17.ON  
214.17.OO  
1x Max 35W GU10

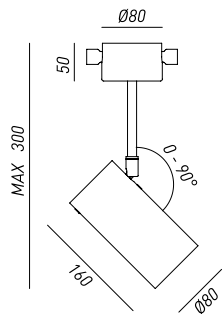

214.05.FF  
214.05.ON  
214.05.OO  
1x Max 50W E27 PAR20

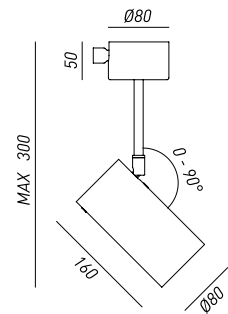

214.15.FF  
214.15.ON  
214.15.OO  
1x Max 50W E27 PAR20

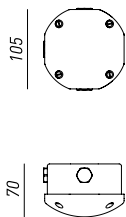

**200.01.00**  
**200.01.ON**  
 Scatola di derivazione - 4 fori entrata  
 Connector block - 4 access holes

FORNITA CON 3 TAPPI 200.05.00  
 SUPPLIED WITH 3 SCREW TOPS 200.05.00  
 IP 40

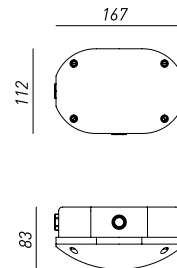

**200.02.00**  
**200.02.ON**  
 Scatola di derivazione - 4 fori entrata  
 Connector block - 4 access holes

FORNITA CON 3 TAPPI 200.05.00  
 SUPPLIED WITH 3 SCREW TOPS 200.05.00  
 IP 40

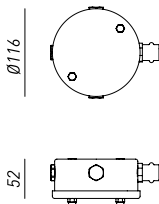

**200.55.00**  
**200.55.ON**  
**200.55.FF**  
 Scatola di derivazione - 4 fori entrata  
 Connector block - 4 access holes

FORNITA CON 3 TAPPI 200.05.00  
 E 1 ATTACCO 1/2" 200.28.00  
 SUPPLIED WITH 3 SCREW TOPS 200.05.00  
 AND 1 1/2" CONNECTION 200.28.00  
 IP 40

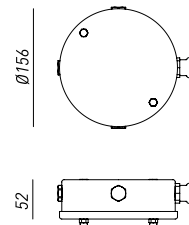

**200.56.00**  
**200.56.ON**  
**200.56.FF**  
 Scatola di derivazione - 4 fori entrata  
 Connector block - 4 access holes

FORNITA CON 3 TAPPI 200.05.00  
 E 1 ATTACCO 1/2" 200.28.00  
 SUPPLIED WITH 3 SCREW TOPS 200.05.00  
 AND 1 1/2" CONNECTION 200.28.00  
 IP 40

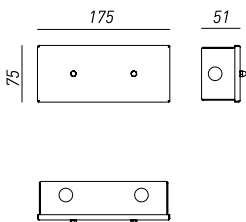

**200.32.00**  
**200.32.ON**  
 Scatola di derivazione - 6 fori entrata  
 Connector block - 6 access holes

FORNITA SENZA TAPPI  
 E ATTACCHI 1/2"  
 SUPPLIED WITHOUT SCREW TOPS  
 AND 1/2" CONNECTIONS  
 IP 40

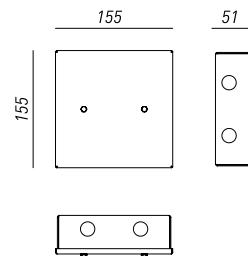

**200.33.00**  
**200.33.ON**  
 Scatola di derivazione - 8 fori entrata  
 Connector block - 8 access holes

FORNITA SENZA TAPPI  
 E ATTACCHI 1/2"  
 SUPPLIED WITHOUT SCREW TOPS  
 AND 1/2" CONNECTIONS  
 IP 40

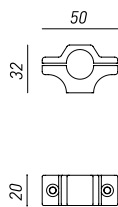

**200.04.00**  
**200.04.ON**  
Supporto a muro per tubo Ø 18 mm  
Piping wall support Ø 18 mm

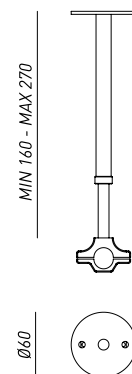

**200.39.01**  
**200.39.N1**  
Supporto a soffitto per tubo Ø 18 mm  
Piping wall support Ø 18 mm



**200.05.00**  
**200.05.ON**  
Tappo 1/2"  
1/2" Plug

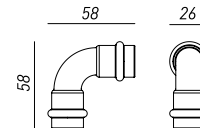

**200.07.RR**  
**200.07.ON**  
Curva 90° per tubo Ø 18 mm  
Piping 90° elbow Ø 18 mm

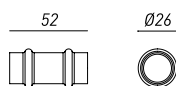

**200.09.RR**  
**200.09.ON**  
Manicotto per tubo Ø 18 mm  
Pipe coupling Ø 18 mm

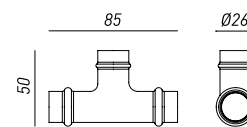

**200.11.RR**  
**200.11.ON**  
Raccordo a T per tubo Ø 18 mm  
Piping union tee Ø 18 mm

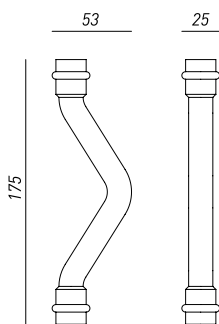

**200.13.ON**  
**200.13.RR**  
 Sorpasso per tubo Ø 18 mm  
 Piping overrunning Ø 18 mm



**200.28.ON**  
**200.28.00**  
 Attacco 1/2" per tubo Ø 18 mm  
 1/2" pipe connection for pipe Ø 18 mm

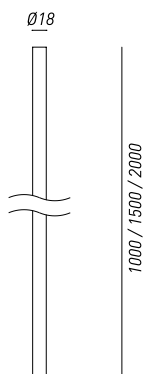

**200.31.100** H 100  
**200.31.10N** H 100  
**200.31.150** H 150  
**200.31.15N** H 150  
**200.31.200** H 200  
**200.31.20N** H 200  
 Tubo liscio Ø 18 mm  
 Smooth pipe Ø 18 mm

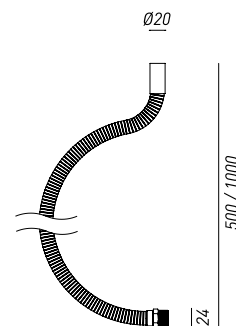

**200.53.050** H 50  
**200.53.05N** H 50  
**200.53.100** H 100  
**200.53.10N** H 100  
 Tubo flessibile con attacco scatola e manicotto  
 per tubo Ø 18 mm  
 Pliant pipe with box connection and coupling  
 for pipe Ø 18 mm

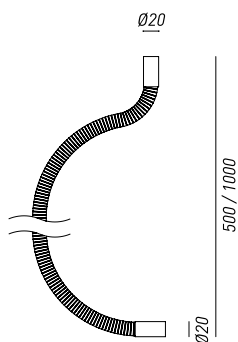

**200.54.050** H 50  
**200.54.05N** H 50  
**200.54.100** H 100  
**200.54.10N** H 100  
 Tubo flessibile con due manicotti per tubo Ø 18 mm  
 Pliant pipe with 2 coupling for pipe Ø 18 mm

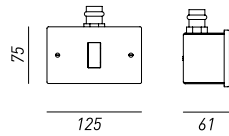

**200.35.01**  
**200.35.N1**  
 Scatola 1 Frutto c/2 fori completa di 1 tappo **200.05.00** e 1 attacco 1/2" **200.28.00** per interruttore BTICINO MAGIC (non fornito)  
 1 way box w/2 holes with 1 screw top **200.05.00** and 1 1/2" connection **200.28.00** for BTICINO MAGIC (not supplied)  
 IP 40

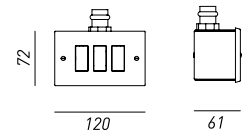

**200.35.03**  
**200.35.N3**  
 Scatola 1 Frutto c/2 fori completa di 1 tappo **200.05.00** e 1 attacco 1/2" **200.28.00** per interruttore BTICINO MAGIC (non fornito)  
 1 way box w/2 holes with 1 screw top **200.05.00** and 1 1/2" connection **200.28.00** for BTICINO MAGIC (not supplied)  
 IP 40

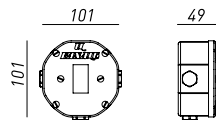

**200.51.0N**  
**200.51.00**  
 Scatola 1 Frutto c/4 fori completa di 3 tappi **200.05.00** per interruttore BTICINO MAGIC (non fornito).  
 1 way box w/4 holes complete with 3 screw tops **200.05.00** for BTICINO MAGIC switch (not supplied).  
 IP 40

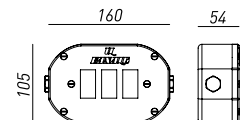

**200.52.0N**  
**200.52.00**  
 Scatola 3 Frutti c/4 fori completa di 3 tappi **200.05.00** per interruttore BTICINO MAGIC (non fornito).  
 3 way box w/4 holes complete with 3 screw tops **200.05.00** for BTICINO MAGIC switch (not supplied).  
 IP 40

optional

PER SOSPENSIONI DA ESTERNO  
FOR OUTDOOR SUSPENSION LAMPS

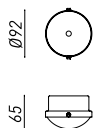

**300.37.R1**  
Basetta 1 entrata per tubo  $\varnothing$  18 mm  
Terminal strip 1 input for piping  $\varnothing$  18 mm  
IP 44

PER SOSPENSIONI DA ESTERNO  
FOR OUTDOOR SUSPENSION LAMPS

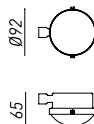

**300.34.R1**  
Basetta 1 entrata per tubo  $\varnothing$  18 mm  
Terminal strip 1 input for piping  $\varnothing$  18 mm  
IP 44

PER SOSPENSIONI DA ESTERNO  
FOR OUTDOOR SUSPENSION LAMPS

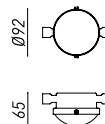

**300.36.R1**  
Basetta 1 entrata per tubo  $\varnothing$  18 mm  
Terminal strip 1 input for piping  $\varnothing$  18 mm  
IP 44

PER / FOR: 247.01/02/03.00\_247.21/22/23.00\_247.31/32/33.00

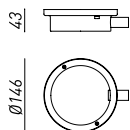

**300.30.R1**  
Controbase 1 entrata per tubo  $\varnothing$  18 mm  
Counterbase 1 input for piping  $\varnothing$  18 mm

PER / FOR: 247.01/02/03.00\_247.21/22/23.00\_247.31/32/33.00

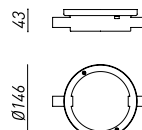

**300.32.R2**  
Controbase 2 entrate per tubo  $\varnothing$  18 mm  
Counterbase 2 inputs for piping  $\varnothing$  18 mm



ACCESSORI BASI AD ANGOLO PER TUTTI GLI APPLIQUES / ANGLE BASE ACCESSORIES FOR ALL APPLIQUES

accessori base angolo / angle base accessories

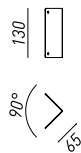

**300.03.00**  
Per basi fino a 150 mm  
For bases up to 150 mm

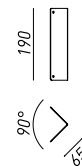

**300.04.00**  
Per basi fino a 250 mm  
For bases up to 250 mm

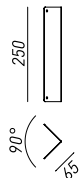

**300.05.00**  
Per basi fino a 350 mm  
For bases up to 350 mm

esempio / example





**RILEGATO**

L'ISPIRAZIONE A FORME GEOMETRICHE PURE E L'ANTICA TRADIZIONE DELLA RILEGATURA A PIOMBO FANNO DELLE LAMPADE DELLA COLLEZIONE RILEGATO DEI VERI E PROPRI SIMBOLI DELLA TRADIZIONE ARTIGIANA ITALIANA E AL CONTEMPO DEI PRODOTTI MODERNI IN GRADO DI ADATTARSI AI CONTESTI INTERNAZIONALI. PRODOTTI UNICI ED ESCLUSIVI, INTERAMENTE FATTI A MANO E REALIZZATI CON VETRO BISELLATO E BASE INTERNA IN OTTONE, DISPONIBILI NELLE FINITURE CROMO, ORO E BRUNITO.

THE LAMPS OF THE RILEGATO COLLECTION, INSPIRED BY GEOMETRIC SHAPES AND THE OLD TRADITION OF LEAD RIMS, ARE A TRUE SYMBOL OF THE ITALIAN ARTISAN HERITAGE. YET, AT THE SAME TIME, THEY ARE MODERN AND SUITABLE FOR ANY INTERNATIONAL CONTEXT. THESE UNIQUE AND EXCLUSIVE PRODUCTS ARE ENTIRELY HANDMADE WITH BEVELED GLASS AND INTERNAL BRASS BASES AND ARE AVAILABLE IN CHROME, GOLD, AND BURNISHED FINISHES.



## lampade / lamps



**MEDINA DP**  
LED 7W 3000K  
MEDINA DPE  
1x Max 57W E27 

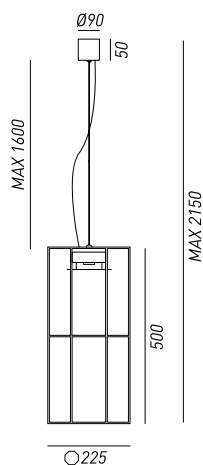

**MEDINA TC**  
LED 7W 3000K  
MEDINA TCE  
1x Max 57W E27 

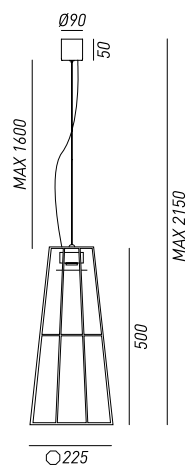

**MEDINA O**  
LED 7W 3000K  
MEDINA OE  
1x Max 57W E27 

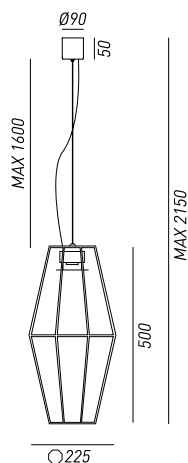

## dettaglio rosoni / canopie's details



**MEDINA DP-TC-O**  
Ø 90 mm H 50 mm

---

*finiture montatura / frame finishes*



OTTONE BRUNITO  
BURNISHED BRASS

---

*vetro / glass*



VETRO TRASPARENTE  
TRANSPARENT GLASS

---



502.00.64



502.00.80



504.00.64



504.00.80



506.00.64



506.00.80

---

*finiture montatura / frame finishes*



OTTONE DORATO  
GOLDEN BRASS



OTTONE CROMATO  
CHROME BRASS



OTTONE BRUNITO  
BURNISHED BRASS

---

*vetro / glass*



VETRO TRASPARENTE  
TRANSPARENT GLASS



lampade / lamps

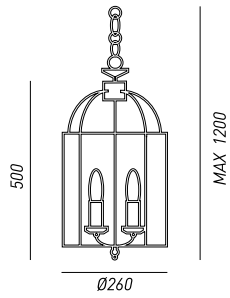

502.00.62  
2 x Max 46W E14

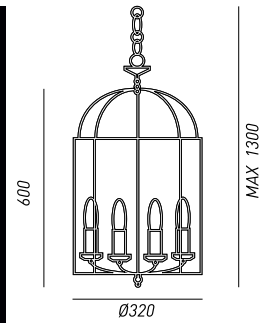

504.00.62  
4 x Max 46W E14

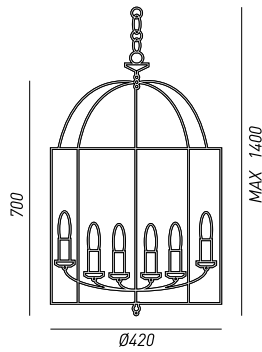

506.00.62  
6 x Max 46W E14

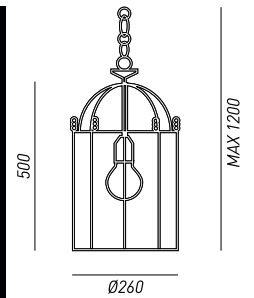

509.00.62  
1 x Max 57W E27

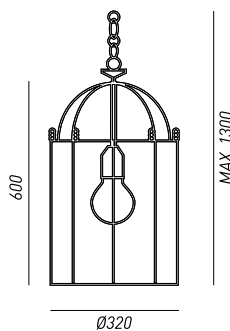

510.00.62  
1 x Max 57W E27

dettaglio rosone / canopie's details



Ø 90 mm H 55 mm  
Rosone standard per tutte le montature  
Standard canopy for all frames

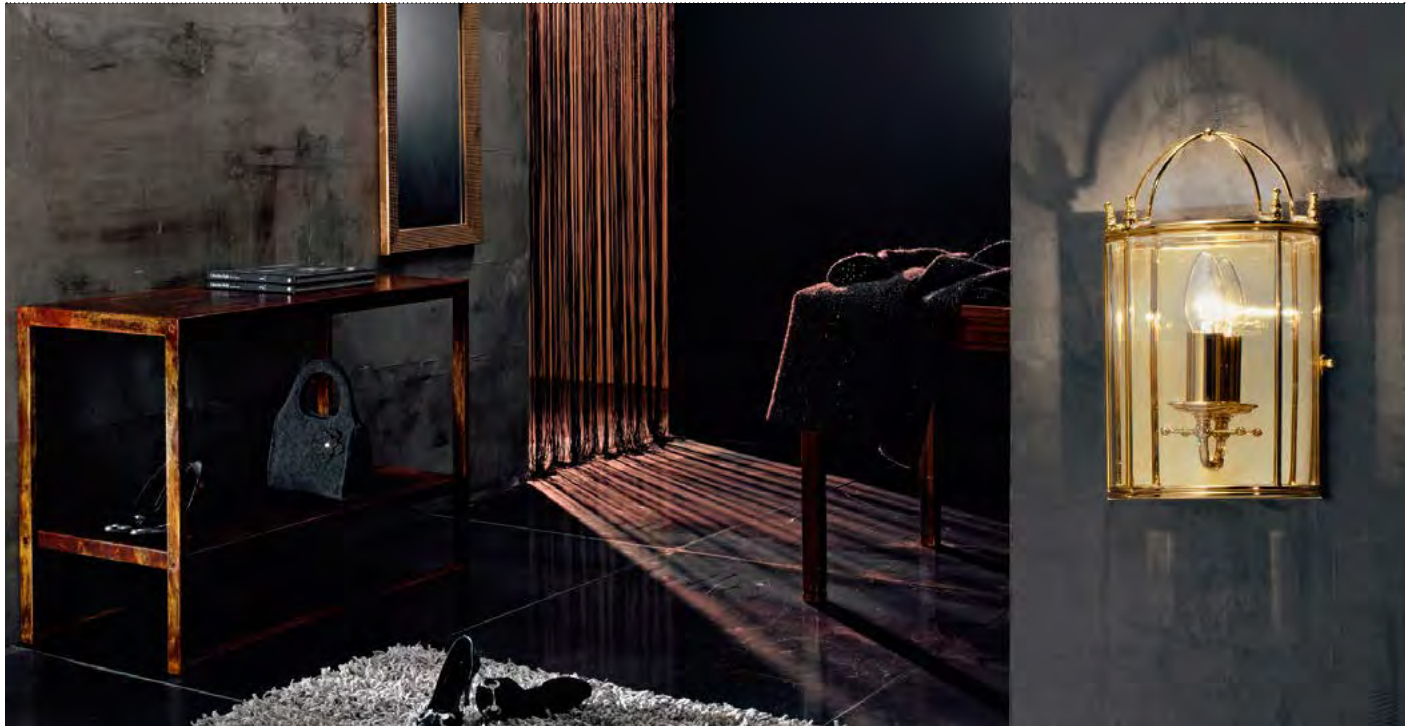

503.00.64



503.00.80



505.00.64



505.00.80

509.00.64



509.00.80



510.00.64



510.00.80



---

*finiture montatura / frame finishes*



OTTONE DORATO  
GOLDEN BRASS



OTTONE BRUNITO  
BURNISHED BRASS

---

*vetro / glass*



VETRO TRASPARENTE  
TRANSPARENT GLASS

---





379.00.64



379.00.80



380.00.64



380.00.80



402.00.64



402.00.80



401.00.64



401.00.80



lampade / lamps

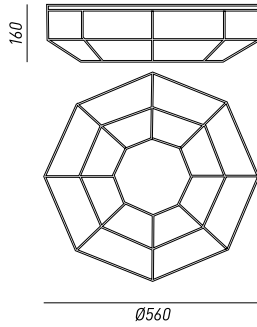

380.00.62  
4 x Max 46W E27

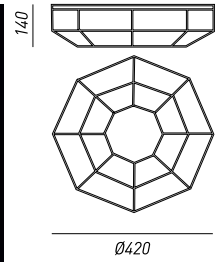

379.00.62  
4 x Max 30W E27

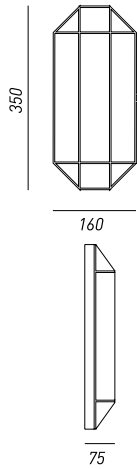

401.00.62  
2 x Max 28W E14

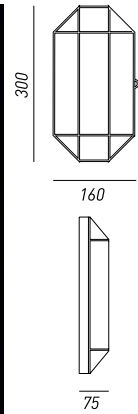

402.00.62  
1 x Max 46W E14

finiture montatura / frame finishes



OTTONE DORATO  
GOLDEN BRASS



OTTONE CROMATO  
CHROME BRASS



OTTONE BRUNITO  
BURNISHED BRASS

vetro / glass



VETRO TRASPARENTE  
TRANSPARENT GLASS



413.00.64



413.00.80



410.00.64



410.00.80



lampade / lamps

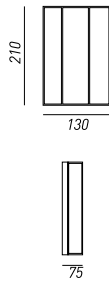

413.00.62  
1 x Max 46W E14 

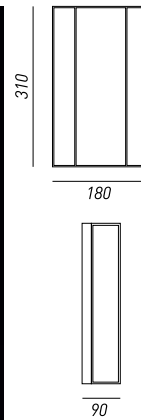

410.00.62  
2 x Max 28W E14 

finiture montatura / frame finishes



OTTONE DORATO  
GOLDEN BRASS



OTTONE CROMATO  
CHROME BRASS



OTTONE BRUNITO  
BURNISHED BRASS

vetro / glass



VETRO TRASPARENTE  
TRANSPARENT GLASS

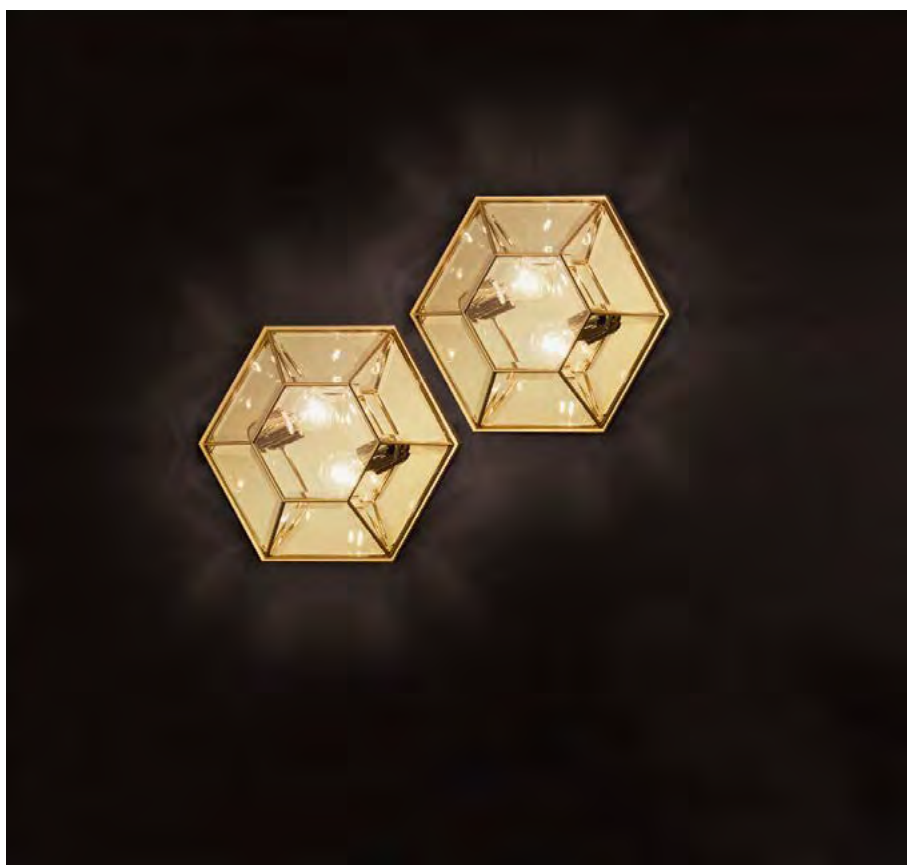



492.00.64

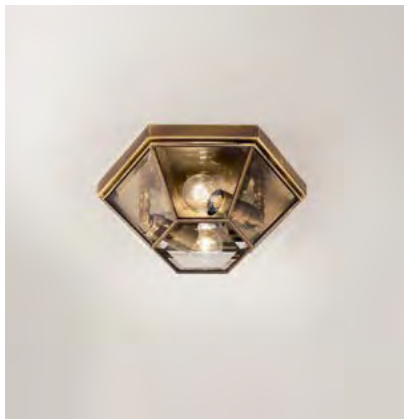

492.00.80



491.00.64



491.00.80



490.00.64



490.00.80



461.00.64



461.00.80

lampade / lamps

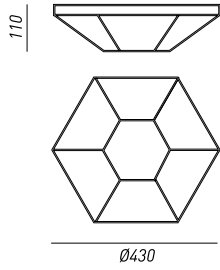

490.00.62  
2 x Max 46W E27

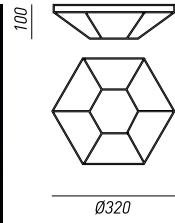
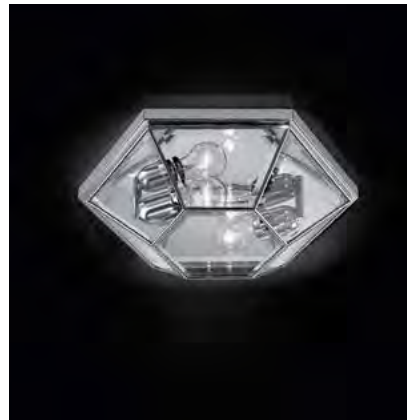

491.00.62  
2 x Max 46W E14

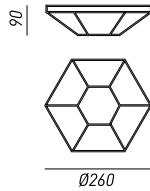
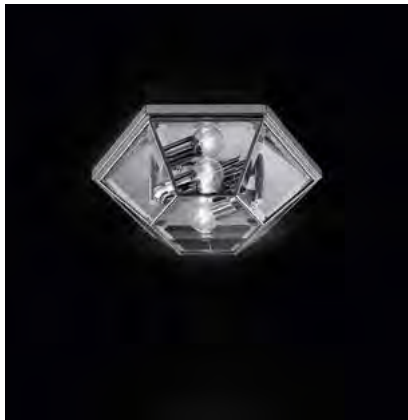

492.00.62  
2 x Max 30W E14

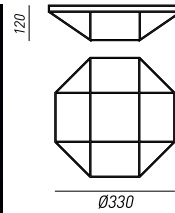

461.00.62  
2 x Max 46W E14



477.00.64



476.00.80



476.00.64



476.00.80

*lampade / lamps*

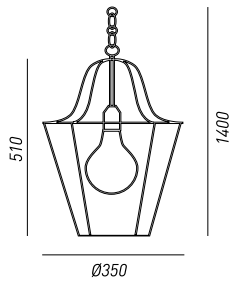

476.00.62  
1 x Max 77W E27

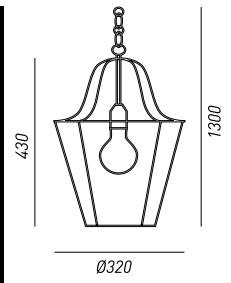

477.00.62  
1 x Max 77W E27

*dettaglio rosoni / canopies details*



Ø 90 mm H 55 mm  
*Rosone standard per tutte le montature*  
*Standard canopy for all frames*

*finiture montatura / frame finishes*



OTTONE DORATO  
GOLDEN BRASS



OTTONE CROMATO  
CHROME BRASS



OTTONE BRUNITO  
BURNISHED BRASS

*vetro / glass*



VETRO TRASPARENTE  
TRANSPARENT GLASS







**COMPANY**

**UNA STORIA FATTA DI LUCE E PASSIONE.**

ALLA BASE DI QUELLA CHE OGGI È UN'AZIENDA CHE RAPPRESENTA NEL MONDO L'ARTIGIANALITÀ E IL MADE IN ITALY C'È LA FAMIGLIA: PERSONE, COLLABORATORI E DIPENDENTI CON GLI STESSI IDEALI GUIDATI DALLA PASSIONE PER IL LAVORO, LA DEDIZIONE E UN DIALOGO APERTO CON L'AZIENDA E VERSO CHI CI LAVORA. IL SUCCESSO DE IL FANALE OGGI È DOVUTO ALLA SOMMA DELLE RISORSE CHE FANNO PARTE DELL'AZIENDA.

**DIETRO IL PRODOTTO CI SONO LE PERSONE.**

CHI LAVORA OGGI NELL'AZIENDA SA CHE È PARTE DI UNA STORIA CHE SI SCRIVE GIORNO DOPO GIORNO, NATA TRENTACINQUE ANNI FA E CHE RAPPRESENTA NEL MONDO LA TRADIZIONE E L'ARTIGIANALITÀ ITALIANA. OGGI L'AZIENDA È GUIDATA DA FAUSTO DALLA TORRE E LUISA MARTIN, AFFIANCATI DAI LORO FIGLI MARZIA E TOMAS.

**FILOSOFIA AZIENDALE.**

**VISION** - L'AZIENDA SI CONCENTRA SULLA CREAZIONE DI PRODOTTI NEL SETTORE DELL'ILLUMINAZIONE DI DESIGN MANTENENDO SEMPRE ATTENTA LA RICERCA TECNICA E MATERICA. I RISULTATI FINORA OTTENUTI HANNO INCORAGGIATO L'AZIENDA A CONTINUARE E SEGUIRE QUESTO APPROCCIO AL FINE DI PORTARE IL FANALE GROUP A ESSERE SEMPRE PIÙ RICONOSCIUTO E RICONOSCIBILE NEL MONDO COME ICONA DI ARTIGIANALITÀ E MADE IN ITALY. L'OBIETTIVO È QUELLO DI OFFRIRE UNA GAMMA DI PRODOTTI DI ALTA QUALITÀ SENZA MAI PERDERE DI VISTA I CRITERI TECNICI, ESTETICI E FUNZIONALI CHE LI CARATTERIZZANO. **MISSION** - L'AZIENDA SI PROPONE DI RAGGIUNGERE GRANDI OBIETTIVI CONTINUANDO PARALLELAMENTE A COLTIVARE LA PASSIONE PER LA LUCE E PER IL DESIGN. LA MISSIONE È QUELLA DI AVERE L'OPPORTUNITÀ E LA RESPONSABILITÀ DI FORNIRE PRODOTTI, CHE NON SI LIMITINO A SODDISFARE LE ESIGENZE DEI SINGOLI, MA CHE RACCONTINO UNA STORIA ALLE PERSONE E ALL'AMBIENTE CHE ANDRANNO A CARATTERIZZARE CON LE PROPRIE PECULIARITÀ.

L'ATTITUDINE PER LE COLLABORAZIONI CON PROGETTISTI E ARCHITETTI APPARTENENTE ALLA FILOSOFIA DELL'AZIENDA RENDE POSSIBILE OGNI GIORNO LA REALIZZAZIONE DI PROGETTI INTERNAZIONALI PER LE PIÙ DIVERSE AMBIENTAZIONI.



**A STORY OF LIGHT AND PASSION.**

AT THE BASE OF WHAT IS NOW A COMPANY THAT REPRESENTS THE CRAFTSMANSHIP AND MADE IN ITALY IN THE WORLD IS THE FAMILY: PEOPLE, PARTNERS AND EMPLOYEES WITH THE SAME IDEALS DRIVEN BY PASSION FOR WORK, DEDICATION AND AN OPEN DIALOGUE WITH THE COMPANY AND WITH THOSE WHO WORK THERE. THE SUCCESS OF IL FANALE GROUP IS DUE TO THE AMOUNT OF RESOURCES THAT ARE PART OF THE COMPANY.

**BEHIND THE PRODUCT THERE ARE PEOPLE.**

THOSE WHO WORK TODAY IN THE COMPANY KNOW THAT THEY ARE A PART OF A STORY THAT IS BEING WRITTEN EVERY DAY, BORN THIRTY FIVE YEARS AGO AND THAT REPRESENTS THE TRADITION AND ITALIAN CRAFTSMANSHIP IN THE WORLD. TODAY THE COMPANY IS LED BY FAUSTO DALLA TORRE AND LUISA MARTIN, ACCOMPANIED BY THEIR CHILDREN MARZIA AND TOMAS.

**BUSINESS PHILOSOPHY**

**VISION** - THE COMPANY FOCUSES ON CREATING PRODUCTS IN THE FIELD OF LIGHTING DESIGN WHILE MAINTAINING CAREFUL TECHNICAL AND MATERIAL RESEARCH. THE RESULTS OBTAINED SO FAR HAVE ENCOURAGED THE COMPANY TO CONTINUE AND FOLLOW THIS APPROACH IN ORDER TO BRING IL FANALE GROUP TO BE MORE AND MORE RECOGNIZED AND RECOGNIZABLE IN THE WORLD AS AN IMAGE OF CRAFTSMANSHIP AND MADE IN ITALY. THE GOAL IS TO OFFER A RANGE OF HIGH QUALITY PRODUCTS WITHOUT EVER LOSING SIGHT OF THE TECHNICAL, AESTHETIC AND FUNCTIONAL CRITERIA THAT CHARACTERIZE THEM.

**MISSION** - THE COMPANY SETS OUT TO ACHIEVE GREAT OBJECTIVES WHILE CONTINUING TO NURTURE PASSION FOR THE LIGHT AND DESIGN. THE MISSION IS TO HAVE THE OPPORTUNITY AND RESPONSIBILITY TO PROVIDE PRODUCTS THAT NOT ONLY MEET THE NEEDS OF THE INDIVIDUALS, BUT THAT TELL A STORY TO PEOPLE AND WORLD THAT WILL BE CHARACTERIZED BY ITS OWN PECULIARITIES.

THE ATTITUDE TO COLLABORATION WITH DESIGNERS AND ARCHITECTS BELONGING TO THE COMPANY'S PHILOSOPHY MAKES THE DAILY INTERNATIONAL PROJECTS FOR MANY DIFFERENT ENVIRONMENTS POSSIBLE.



FOTO SCATTATA NEL 2010 / PICTURE TAKEN IN 2010



# MANUFACTURING

LE NOSTRE LAMPADE SONO OPERE "DI ARTE E DI LUCE", IN GRADO DI INSERIRSI IN CONTESTI CONTEMPORANEI COME RICHIAMI ALLA TRADIZIONE ITALIANA.

ABBIAMO FATTO DEL MADE IN ITALY IL NOSTRO SEGNO DISTINTIVO.

LA PRODUZIONE, INTERAMENTE ITALIANA, È IN GRADO DI FONDERE ALLA PERFEZIONE UN SUBLIME ARTIGIANATO CON LE PIÙ RECENTI TECNICHE D'ILLUMINAZIONE DANDO VITA COSÌ A PRODOTTI UNICI E SENZA TEMPO, MANTENENDO INALTERATA LA MATERIA PRIMA.

IL DESIGN DI OGNI COLLEZIONE SI CONFIGURA COME SINTESI PERFETTA DI FORMA E FUNZIONE CHE, UNITO A UN'ELEVATA QUALITÀ DEI MATERIALI E UNA PREMUROSA LAVORAZIONE RENDE OGNI PRODUZIONE UNICA E NON STANDARDIZZATA: UN'EDIZIONE SPECIALE.

IL FANALE PROPONE PRODOTTI CARATTERIZZATI DA UN ALTO CONTENUTO PROGETTUALE RIVOLGENDOSI A UN PUBBLICO CHE ABBIA UNO STILE PERSONALE E RICERCATO, SENZA PERÒ TRASCURARE LE PIÙ ATTUALI TENDENZE.

LE LINEE SEMPLICI, PULITE ED ELEGANTI CON CONTAMINAZIONI INTERNAZIONALI SI INTEGRANO E RISPETTANO LA MANUALITÀ ARTIGIANA ITALIANA DANDO VITA A LAMPADE CONTRADDISTINTE DA UN EQUILIBRIO DI VOLUMI E PROPORZIONI E UNA CREATIVITÀ SENZA ECCESSI CHE RISALTA IL VALORE APPARTENENTE AL PRODOTTO. UN VALORE RACCONTATO ATTRAVERSO LE SAPIENTI MANI DEI NOSTRI ARTIGIANI CHE GRAZIE ALL'UTILIZZO DI MATERIALI DI QUALITÀ E UNA FORTE ATTENZIONE ALLE TECNICHE PRODUTTIVE CONFERISCE VALORE AGGIUNTO A PRODOTTI "SARTORIALI".

CI PIACE DEFINIRCI COME "SCULTORI DELLA LUCE". E' PROPRIO PARTENDO DA QUESTO PRESUPPOSTO CHE PLASMIAMO LA MATERIA E DIAMO FORMA ALLE EMOZIONI CREANDO PEZZI UNICI: PRODOTTI PERSONALIZZATI E FATTI SU MISURA PER I NOSTRI PROGETTI D'ARREDO.

TEAM IL FANALE

#### MATERIALI

I MATERIALI UTILIZZATI PER LA REALIZZAZIONE DI TUTTE LE LAMPADE IL FANALE, SONO QUELLI PIÙ RAPPRESENTATIVI DELLA TRADIZIONE: OTTONE, RAME, FERRO.

I VETRI DI MURANO E LE CERAMICHE DI BASSANO RAPPRESENTANO INVECE LE PIÙ ALTE ESPRESSIONI DEL MADE IN ITALY. I METALLI CON I QUALI REALIZZIAMO LE NOSTRE LAMPADE, SONO SOTTOPOSTI AD UN PARTICOLARE TRATTAMENTO DI OSSIDAZIONE ACCELERATA CHE CONFERISCE UNA PATINA D'INVECCHIAMENTO, CHE NOI DEFINIAMO "ANTICATO".

I TRATTAMENTI POST LAVORAZIONE E LE PROCEDURE CHE VENGONO UTILIZZATE PER GIUNGERE AL PRODOTTO FINALE RISPETTANO METODI ARTIGIANALI E TRADIZIONALI APPARTENENTI ALLA FAMIGLIA E TRAMANDATI FINO AD OGGI.

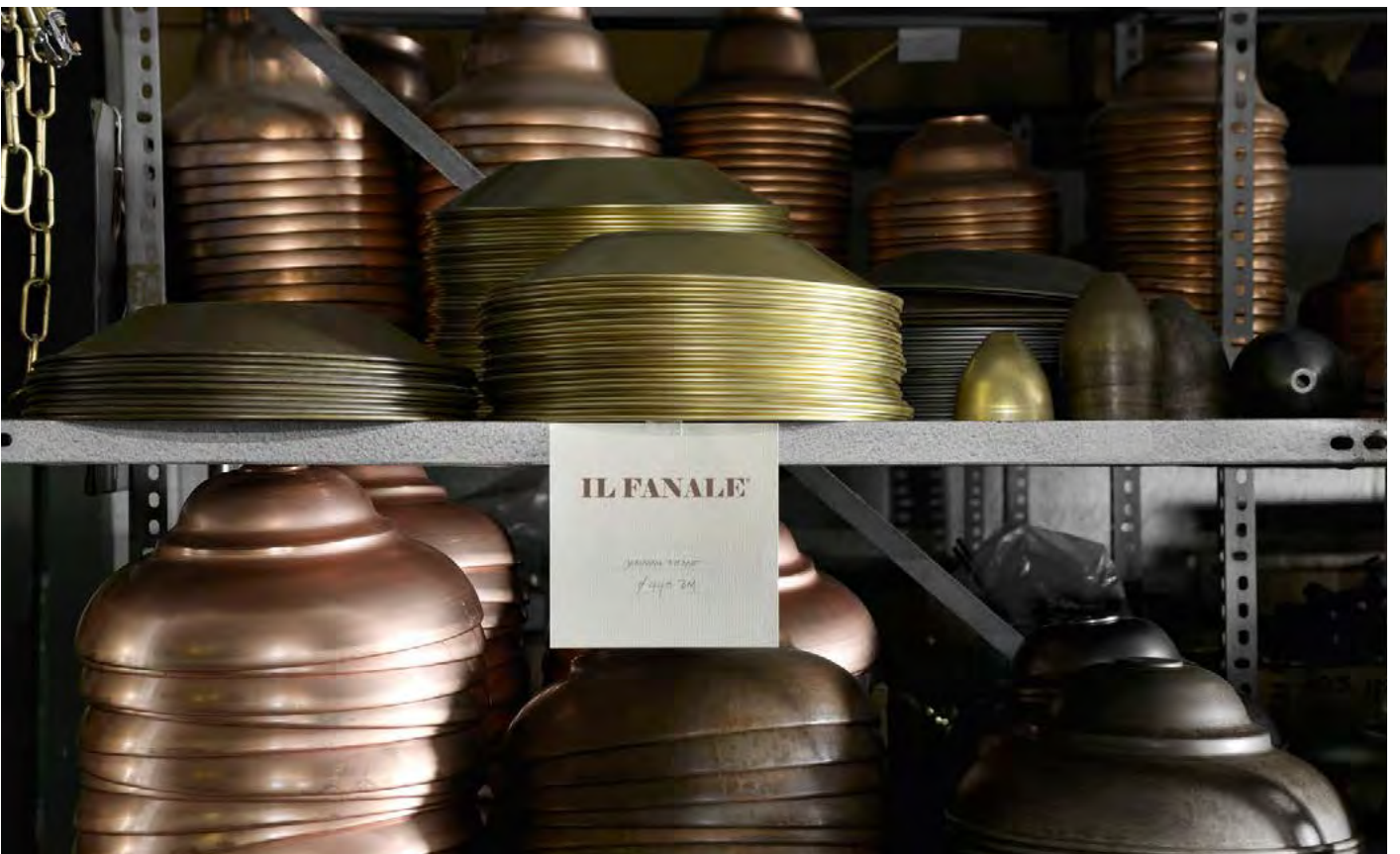

**OUR LAMPS ARE WORKS "OF ART AND LIGHT" THAT CAN ENTER THE CONTEMPORARY CONTEXTS AS REFERENCES TO THE ITALIAN TRADITION.**

**THE MADE IN ITALY IS OUR HALLMARK.**

THE PRODUCTION, BEING ENTIRELY ITALIAN, IS ABLE TO JOIN TO PERFECTION SUBLIME HANDICRAFTS WITH THE LATEST ILLUMINATION TECHNIQUES THUS GIVING LIFE TO UNIQUE AND TIMELESS PRODUCTS, WHILE MAINTAINING THE RAW MATERIAL UNCHANGED.

THE DESIGN OF EACH COLLECTION IS THE PERFECT SYNTHESIS OF FORM AND FUNCTION WHICH, COMBINED WITH HIGH QUALITY MATERIALS AND A THOUGHTFUL PROCESS MAKES EACH UNIQUE AND UNCONVENTIONAL PRODUCTION: A SPECIAL EDITION.

IL FANALE GROUP OFFERS PRODUCTS WITH A HIGH DESIGN CONTENT APPEALING TO AN AUDIENCE THAT HAS A PERSONAL AND SOPHISTICATED STYLE, WITHOUT NEGLECTING THE LATEST TRENDS.

THE SIMPLE, CLEAN AND ELEGANT LINES WITH INTERNATIONAL INFLUENCES, COMPLEMENT AND RESPECT THE ITALIAN MANUAL HANDCRAFTS, CREATING LAMPS DISTINGUISHED BY THE BALANCE OF VOLUMES AND PROPORTIONS AND THE CREATIVITY WITHOUT THE EXCESSIVENESS THAT BRINGS TO THE FORE THE VALUE OF THE PRODUCT. A VALUE TOLD BY THE SKILLED HANDS OF OUR CRAFTSMEN WITH THE USE OF QUALITY MATERIALS AND A STRONG FOCUS ON PRODUCTION TECHNIQUES CONFERS AN ADDITIONAL VALUE TO "SARTORIAL" PRODUCTS.

**WE LIKE TO DEFINE OURSELVES AS "SCULPTORS OF LIGHT." AND 'PRECISELY FROM THIS ASSUMPTION THAT WE SHAPE THE MATTER AND GIVE SHAPE TO THE EMOTIONS, CREATING UNIQUE PIECES AND CUSTOM-MADE PRODUCTS TAILORED FOR OUR FURNITURE PROJECTS.**  
IL FANALE TEAM

#### **THE MATERIALS**

THE MATERIALS USED FOR THE PRODUCTION OF ALL IL FANALE LAMPS, ARE THOSE MOST REPRESENTATIVE OF THE TRADITION: **BRASS, COPPER, IRON.**

**THE MURANO GLASS AND CERAMICS OF BASSANO** REPRESENT ON THE OTHER HAND THE HIGHEST EXPRESSIONS OF MADE IN ITALY. THE METALS WE USE TO CREATE OUR LAMPS ARE SUBJECTED TO A SPECIAL TREATMENT OF ACCELERATED OXIDATION THAT GIVES A GLOSS OF AGING, WHICH WE REFER TO AS "ANTIQUE" LOOK.

THE POST-PROCESSING TREATMENTS AND PROCEDURES THAT ARE USED TO REACH THE FINAL PRODUCT COMPLY WITH TRADITIONAL METHODS BELONGING TO THE FAMILY AND PASSED ON UNTIL NOW.



# PROJECTS

VUOI CHE I TUOI PROGETTI VENGANO PUBBLICATI?  
SPEDISCI LE FOTO A [MARKETING@ILFANALE.COM](mailto:MARKETING@ILFANALE.COM)

WANT TO GET YOUR PROJECTS FEATURED?  
SEND YOUR PICTURES TO [MARKETING@ILFANALE.COM](mailto:MARKETING@ILFANALE.COM)

**ABBIAMO DATO FORMA A GRANDI PROGETTI DI DESIGN IN TUTTO IL MONDO.**

IL FANALE SOSTIENE LO SVILUPPO DI GRANDI PROGETTI NEL MONDO REALIZZATI GRAZIE A COLLABORAZIONI CON ARCHITETTI E PROGETTISTI DI FAMA INTERNAZIONALE. UN NETWORK CHE RIUNISCE PROFESSIONISTI E "ARTISTI" CON LO SCOPO DI ILLUMINARE SPAZI PRIVATI E AMBIENTI URBANI NEL MONDO CON LA GARANZIA DEL MARCHIO IL FANALE. LA NOSTRA ESPERIENZA NEL SETTORE CI PERMETTE DI SUPERARE OSTACOLI TECNICI E FORNIRE SOLUZIONI PERSONALIZZATE AL FINE DI SODDISFARE LE ESIGENZE DI OGNI SINGOLA REALIZZAZIONE. OGNI PROGETTO È CARATTERIZZATO DALLA PERFETTA FUSIONE TRA LIGHTING DESIGN E ARTIGIANALITÀ. OGGI IL FANALE È UN AZIENDA CONOSCIUTA IN TUTTO IL MONDO PER LE SUE LAMPADE DI QUALITÀ E RAPPRESENTATIVE DEL MADE IN ITALY.

**WE HAVE CREATED MAJOR DESIGN PROJECTS AROUND THE WORLD.**

IL FANALE SUPPORTS THE DEVELOPMENT OF MAJOR PROJECTS IN THE WORLD ACHIEVED THROUGH COLLABORATIONS WITH ARCHITECTS AND DESIGNERS OF INTERNATIONAL FAME. A NETWORK THAT GETS TOGETHER PROFESSIONALS AND "ARTISTS" WITH THE GOAL OF ILLUMINATING PRIVATE SPACES AND URBAN SURROUNDINGS IN THE WORLD WITH THE GUARANTEE OF THE BRAND IL FANALE. OUR EXPERIENCE ALLOWS US TO OVERCOME TECHNICAL BARRIERS AND PROVIDE CUSTOMIZED SOLUTIONS TO MEET THE NEEDS OF EVERY SINGLE PRODUCTION. EACH PROJECT IS CHARACTERIZED BY THE PERFECT BLEND OF LIGHTING DESIGN AND CRAFTSMANSHIP. TODAY, IL FANALE IS A COMPANY KNOWN ALL OVER THE WORLD FOR ITS QUALITY LAMPS AND THE MADE IN ITALY LOGO.



BARRACA RODIZO Grill & Bar HOLLAND



SEMELI WINERY GREECE



BUENA VISTA HOTEL AUSTRALIA



THE LAMB SHOP AUSTRALIA



GESTO ITALY



AGRITURISMO LOGHINO BELSITO ITALY



CRINITI'S AUSTRALIA



GOODY'S BURGER HOUSE GREECE



RESIDENTIAL USA



THE CARRIAGE ROOMS NORTHERN IRELAND



WERSENS SWEDEN

Barraca Rodizo Grill & Bar / HOLLAND  
Photo credits: Barraca Rodizo Grill & Bar



Semeli Winery / GREECE  
Photo credits: Semeli Winery



Buena Vista Hotel / AUSTRALIA

Project by SJB Interiors in collaboration with Tess Regan Design / Photo credits: Felix Forest / Images courtesy of: LightCo











The Lamb Shop / AUSTRALIA

Project by LightWorks / Photo credits: LightCo







**CAFFETERIA**

- Espresso 1
- Caffè americano 2
- Caffè americano speziato 2
- Macchiato 2
- Latte macchiato 2
- Latte 2
- Latte & biscotti 3
- Corona calda (con pasta) 3

**BEVERAGE**

- Acqua (0,50) 1
- Succhi di frutta 2,5
- Birra chiara piccola / media 3/4,5
- Birra rossa piccola / media 3,5/5
- Gottoso di vino bianco / rosso 1
- Birre artigianali (0,33 / 0,75) 5/12

**DRINK**

- Longdrink 5
- Pastati 6
- Frozen 5
- Amari 3
- Whisky 3

**VINI**

- Bollicine 5
- Vini bianchi 5
- Vini rossi 3
- Vini dolci 3

**LA NOSTRA  
È UNA SELEZIONE  
DI VINI BIOLOGICI  
E BIODINAMICI**

**UN GESTO  
Semplice &  
AUTENTICO**



Agriturismo Loghino Belsito / ITALY

Project by Vesperini Della Noce Designers / Photo credits: Fabio Cattabiani



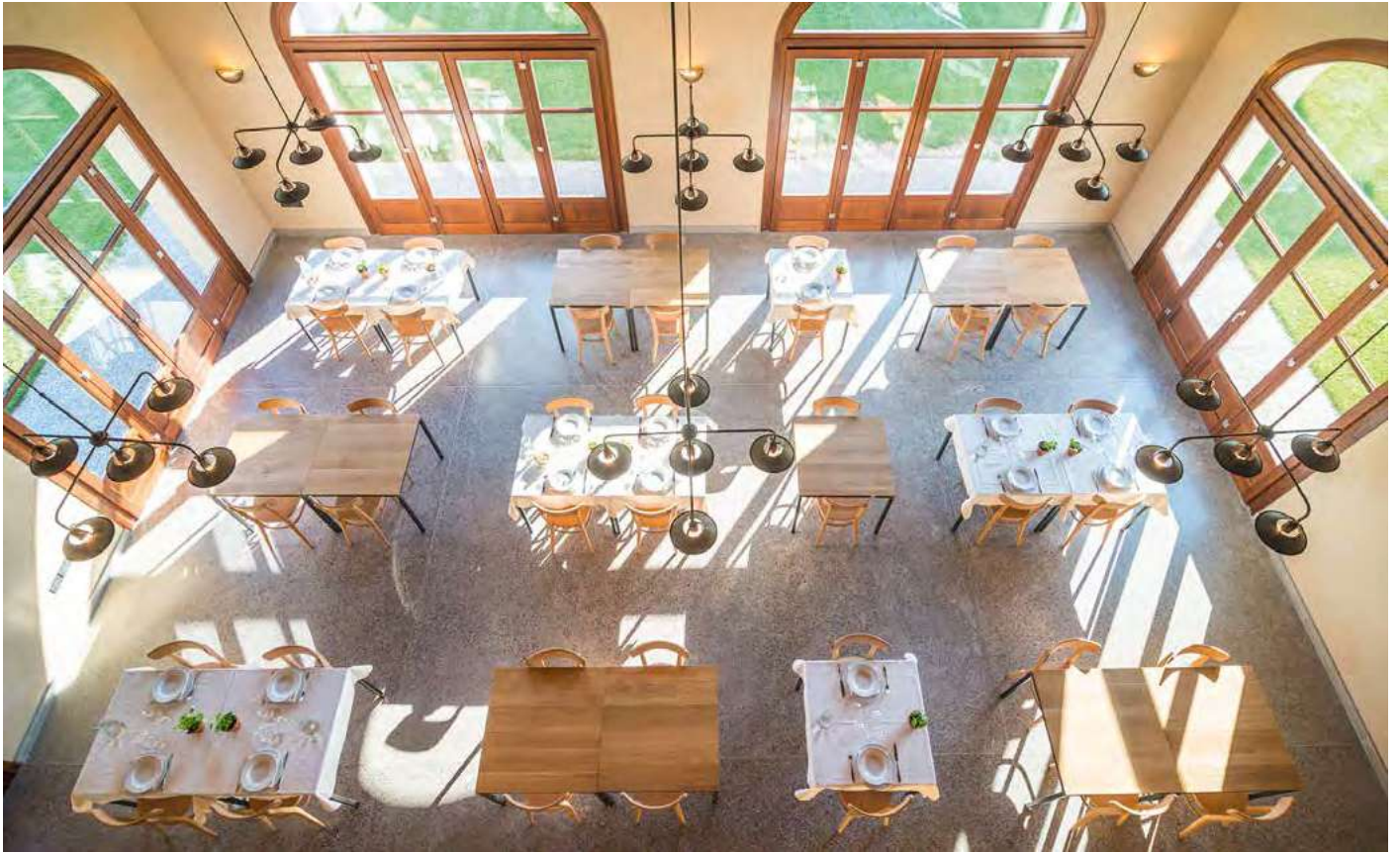

Criniti's / AUSTRALIA  
Project by LightCo











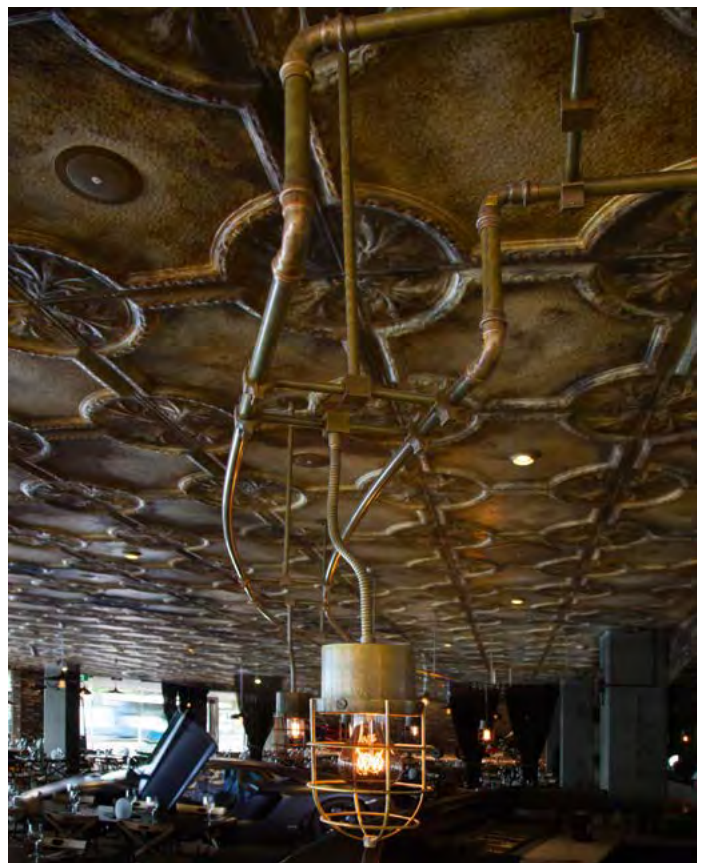



Goody's Burger House / GREECE  
Project by Chadios+Associates Studio





Residential / USA  
Project by Alison Kandler







The Carriage Rooms / NORTHERN IRELAND  
Project by John J O'Connel Architects and DLight Concepts Limited





Wersens / SWEDEN  
Wersens Brasserie, Bar and Restaurant







VECKANS TIPS  
FÖRRÄT: GUBBRÖRA MED KEALLAD, KAVR  
JÄMNT SKOTT RENIGT RÅR MED OXSV  
PÅ PURE RÅR MED MÅLAKRAD MÅR  
RÖRFRÄN LANDIN MED SKALDJURSRIS  
KALL SURDEGSKRUTNINGER  
OSSO BULO PÅ MÄRGPÅ FRÅN FJÄLLBETE  
GREMOLATA  
SVAMPQUESADILLA MED TOMATSALLAD  
DESSERT: CHOKLADKRÄM MED RÅRÖRDA



NET & KALLLÖJROM	95:
ANSRAGU, TRATTKANTAREUSKARAKA KÖVA SAMT RÖDVINSSAS	295:
SOTTO, TOMATVINAIGRETTE, BÖNOR,	269:
MED SAFFRANS RISOTTO &	159:
& GHILOYOGHURT	169:
LINGON & BRYNT SMÖR	75:







# F.A.Q

ITA

**Siete produttori?**

*L'intera produzione delle nostre lampade è interna all'azienda ed è realizzata artigianalmente.*

*Per i vetri di Murano e le ceramiche di Bassano, ci affidiamo a produttori specializzati esterni.*

**Producez anche lampade su Misura?**

*Sì, realizziamo lampade che non fanno parte del nostro catalogo ma che sono create per soddisfare particolari esigenze e/o per progetti e realizzazioni di determinati spazi.*

**Che materiali utilizzate per i vostri prodotti?**

*I materiali utilizzati per la realizzazione delle nostre lampade sono: ferro, ottone, rame vetro e ceramica.*

**Quali sono le vostre finiture?**

*Le finiture che utilizziamo sono: ottone anticato, ferro anticato, rame anticato, foglia oro, foglia argento e foglia rame.*

*E' possibile su richiesta scegliere una finitura diversa da quella presente sul catalogo.*

**Posso avere il cavo di una sospensione di un colore diverso?**

*Sì, i cavi sono disponibili in bianco e in marrone.*

**Le vostre lampade subiscono alterazioni nel tempo?**

*Sì, questi cambiamenti rappresentano una peculiarità dei nostri prodotti che subiscono un processo di ossidazione accelerata che continua poi naturalmente fino a raggiungere la sua completa maturazione. Il prodotto così subisce cambiamenti dovuti anche a fattori temporali e all'esposizione agli agenti atmosferici. Su richiesta, il processo di ossidazione può essere bloccato attraverso una specifica lavorazione.*

**Come si puliscono le vostre lampade?**

*Le nostre lampade possono essere spolverate, ma non lavate. Applicando infatti qualsiasi prodotto per la pulizia potreste rovinare la patina che le caratterizza.*

**Le vostre lampade sono complete di lampadine?**

*No, le lampade sono sprovviste di lampadine. Le immagini sul catalogo sono solo a scopo illustrativo. Per acquistarle rivolgetevi ai punti vendita di materiale elettrico.*

**Dove posso trovare tutti i dettagli tecnici?**

*Per i dettagli tecnici aggiornati invitiamo a seguire il nostro sito web: [www.ilfanale.com](http://www.ilfanale.com)*

**Come posso registrarmi come nuovo cliente?**

*Puoi registrarti come nostro cliente all'interno del sito web [www.ilfanale.com](http://www.ilfanale.com), compilando il modulo all'interno dell'area riservata.*

*Il Fanale Group srl si riserva il diritto di sospendere la produzione in qualunque momento e senza preavviso di qualsiasi articolo e, ferme restando le caratteristiche dei modelli descritti, di apportare variazioni di prezzo, modifiche di parti e dettagli che per qualsiasi esigenza di carattere produttivo ritenesse opportuno.*

*Per qualsiasi controversia viene riconosciuta la competenza esclusiva dell'autorità giudiziaria di Treviso.*

ENG

**Are you a manufacturer?**

*We manufacture everything in house and by hand. We trust external experts for the production of Murano glass and Bassano ceramic.*

**Do you manufacture made-to-order lamps?**

*Yes, we do make made-to-order lamps that are not included in our catalogue but meet special needs and/or requirements for the design of particular spaces.*

**What materials do you use for your lamps?**

*The materials we use for our lamps range from iron to brass, copper, glass, and ceramic.*

**What finishes do you offer?**

*Our range of finishes includes: antiqued brass, antiqued iron, antiqued copper, gold leaf, silver leaf and copper leaf. Upon request, we provide different finishes from those listed in the catalogue.*

**Is it possible to have a different colored suspension cord?**

*Yes, cords are available in both brown and white.*

**Do your lamps change over time?**

*Yes, changes in our products represent a unique feature of our lamps that undergo an accelerated oxidation process that continues naturally until it has reached its complete maturation. Our lamps can also be affected by time and weather conditions. Upon request, the oxidation process can be stopped through a special treatment with a transparent varnish.*

**What is the best way to clean your lamps?**

*Our lamps can be dusted, but not washed. Applying any type of cleaning product can, in fact, ruin the characteristic patina.*

**Do your lamps come with light bulbs?**

*No, our lamps do not come with light bulbs. Those shown in the catalogue are for illustrative purposes only. You must go to your nearest electrical equipment store to purchase them.*

**Where can I find all of the technical information?**

*For all updated technical information please visit our website: [www.ilfanale.com](http://www.ilfanale.com).*

**How can I register as a new client?**

*You can register as a client on our website [www.ilfanale.com](http://www.ilfanale.com) by filling out the form in the reserved client area.*

*Il Fanale Group srl reserves the right to suspend any product from the production range without notification. Moreover it reserves the right to make any change (prices, technical details) without prior notice, maintaining the essential characteristics of the article should the need arise for its improvement.*

*Any disputes arising out of these terms of sale shall be exclusively settled by the court of Treviso, Italy.*





**Il Fanale Group srl**

Via Bredariol 15

31048 San Biagio di Callalta (TV) Italy

Tel. +39 0422 895200

Fax +39 0422 895110

info@ilfanale.com

www.ilfanale.com

**Credits**

Concept: Il Fanale Group srl & Varianti srl unip.

Photography and colour separation: varianti.it

Copyright: Il Fanale Group srl & Varianti srl unip.

Printed by: Grafiche Antiga

2017



