



i-LÈD

Retail lighting inspiration

linealightgroup

Pound



40

Pound_1



40

Pound_2



41

Pound_3



42

Pound_4

Angular



50

Angular_1



50

Angular_2



51

Angular_3



51

Angular44_3



52

Angular_4



52

Angular_4 DALI



53

Angular44_4



56

Angular_5



56

Angular_5 DALI



57

Angular44_5



59

Angular_P4



59

Angular_P5

Optus_T



64

Optus_T1



64

Optus_T2



65

Optus_T1 EYE-WiFi



65

Optus_T2 EYE-WiFi

Iris



70

Iris_T0



70

Iris_T1



71

Iris_T2



71

Iris_T3

Track System



76

Track System

Optus_W



81

Optus_W2



81

Optus_W3

Tee



84

Tee_1



85

Tee_2

Creek



92

Creek_85



96

Creek_130

large scale distribution range index

Fresh Food



108

Angular_4



108

Optus_EX2

linear range index

Trail_line



118

Trail_line



120

Accessories

Bulbo



124

Chlorophyll



124

Vertical



126

Thin



127

Reika

Optus_EX



134

Optus_EX1



135

Optus_EX2

Illuminator



141

Mini-Illuminator



143

Illuminator



143

Illuminator



140/142

1 x Casing



140/142

2 x Casing



140/142

3 x Casing

Blob40



148

Blob40_1



148

Blob40_2

Cob40



151

Cob40_R



151

Cob40_RJ

Cob44



154

Cob44_R



154

Cob44_RJ



155

Cob44_Q



155

Cob44_QJ

Cob20



160

Cob20_R



162

Cob20_Q

LV44_RD



170

LV44_RD01



170

LV44_RD02



170

LV44_RD03



171

LV44_RD04



171

LV44_RD05

Tour



180

Tour_PD



181

Tour_PU



182

Tour_PI

Baton



186

Baton_P



186

Baton_P



185

Baton_P



186

Baton_P

TU-O / TU-V



190

Tu-O



190

Tu-V

Straight_P

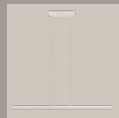

194

Straight_P1



194

Straight_P3

Oh!



198

Oh!_P



199

Oh!_PMX



199

Oh!_S

Box



204

Box_SR



205

Box_SQ

Over Voltage
Protection

208

Defender

ON/OFF Control
gears C.C.

210

Bit



210

Slim



210

Mini_Penny



211

Leon



211

Clerk

Control
System C.C.

212

Boson



212

Mini Jolly



213

Planck



213

Photon



214

Argo



214

Serban



215

Dual



215

Theo



216

Reson



216

Nyquist



216

Bode DALI



217

Ervin

Dali Controller



218

Dali_PS1



218

Dali_PS2



218

Dali_USB



218

Dali_XC



219

Dali_Msensor



219

Dali_RC

Emergency



220

Sepic



220

Boost



221

Emergency kit

Wi-Fi Connection



223

Gateway



223

Linksys



223

TP_Link

WE TURN IDEAS
INTO QUALITY DESIGN
100% MADE IN ITALY.

We design, develop,
create lighting solutions.

Experience and Expertise
enrich our vision,
thanks to a know-how that
increases with each new product.

**Today i-LèD is synonymous
with cutting-edge lighting technology.**

RETAIL





ACCESS
NYC
IN A
NEW YORK
MINUTE

JOSEPH

fitting rooms

DIANE
FURSTEN

TAILOR MADE DESIGN

Our mission is to build a close relationship with designers, **looking for optimal results that can best highlight the beauty and design of the visual concept.** We deeply believe in this relationship and we are ready to put all our knowledge and technological savvy into the “creative mix”.

We study new solutions working side by side, as we are convinced that this synergy can give rise to ideal answers.

Walter Steiger | Paris – France





TECHNOLOGY AVAILABLE TO CLIENTS AND PRODUCTS DEDICATED TO THE PROJECT

Thanks to LED technology, today a lighting project is more articulated and precise than ever. We are able to offer immediate energy savings due to reduced consumption, clear benefits in terms of colour rendering and protection of the goods on display, thanks to fixtures devoid of harmful emissions.

We have developed ad hoc, simple and performing products, able to solve the problems traditionally related to installation, and achieve the versatile lighting required for this type of environments. Using latest generation sources allows us to reduce the size of the luminaires to a minimum, eliminating their visual impact when installed, as well as ensuring high quality and excellent luminous efficiency.

THE PERFECT LIGHTING:
OPTICALS' RESEARCH AND DEVELOPMENT.

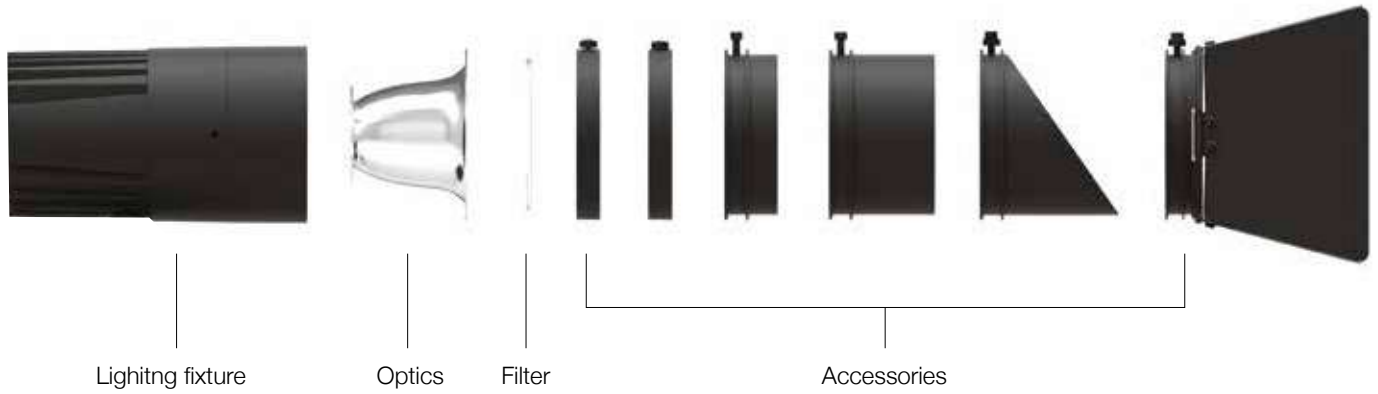

Each LED is configured to emit a certain amount of light, which changes with the addition of the optical system. The task of defining the light beam coming out of the lighting fixture is entrusted to a dedicated optical system, whose proven efficiency optimizes the source output.

Continuous research, our know-how acquired over the years, and the development of lenses and reflectors designed around LEDs allow us to propose new technical applications that can maximize the experience of lighting design in a rigorous and effective way.

S_

Spot | 10° - 19°

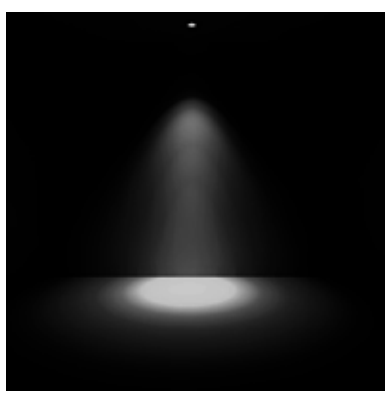

MF_

Medium Flood | 20° - 39°



F_

Flood | 40° - 69°

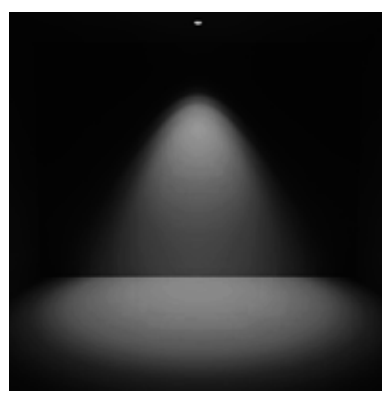

DESIGNED TO LAST OVER TIME: DISSIPATION ACCORDING TO i-LèD.



A quality product must be reliable and long lasting. Each fixture is planned and designed to fully express the potential of the source. In the design of a luminaire, aesthetics is not our only concern: indeed, the main role of the casing is to ensure that operating temperature stays below a certain threshold.

An LED luminaire can easily reach high temperatures, capable of altering its performance and life cycle. This is why it is essential to design an effective heat sink element, to increase performance and extend the life of the product.

Our lighting fixtures feature passive thermal dissipation: this allows the casing to always maintain temperatures below 60 degrees centigrade, optimizing the passage of heat from the printed circuit housing the LED to the external environment. The absence of active dissipation systems, such as fans, simplifies the mechanical and electronic structure of our products, thus ensuring greater overall reliability over time.



Temperature (Solid) [°C]
TMAX (°C) Radiator: contours

In the LED data sheet the value “**B**”, followed by a value normally included between 10 and 50, indicates the quality of the diode used as it defines the percentage of LEDs that, at the end of normal 223'824 hours, does not maintain the flow characteristics bright state. A LED declared as L70B10 = **223.824 hours** indicates that upon reaching **223.824 hours**, 90% (B10) of the diodes has a residual luminous flux equal to or greater than 70% of the initial flow (L70).

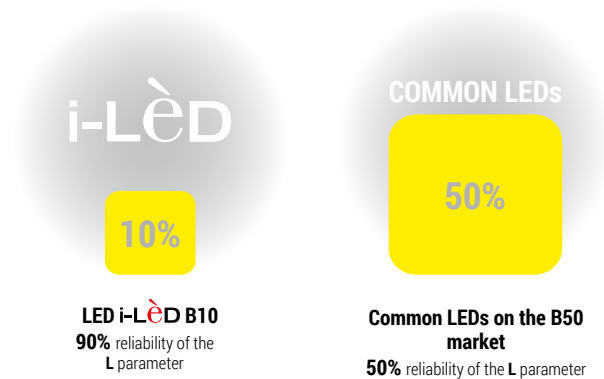

LONG LED LIFE EXPECTANCY

arrayLED	→						B10 L70 Ta 25°C
100 % 0 h	40'000 h	80'000 h	120'000 h	160'000 h	200'000 h	223'824 h	
topLED	→						B10 L70 Ta 25°C
100 % 0 h	10'000 h	20'000 h	30'000 h	40'000 h	50'000 h	60'000 h	72'100 h
powerLED (Cree XP-G2)	→						B10 L70 Ta 25°C
100 % 0 h	70'000 h	140'000 h	210'000 h	280'000 h	350'000 h	365'464 h	





Italia meridionale

Friuli Venezia



NOT ONLY AESTHETICS AND DESIGN

The Rendering Index (CRI) quantifies the ability of a light source to reproduce in a more realistic and natural way the colour shades of illuminated objects. Traditionally the CRI is defined through sample sources: 14 colour plates, characterized by different luminance levels.

The evaluation parameters are based on a scale ranging from 0 to 100.

CRI v

CRI colour range

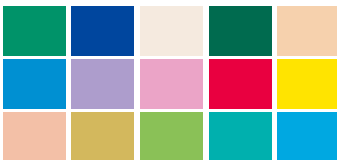

TM-30 colour range

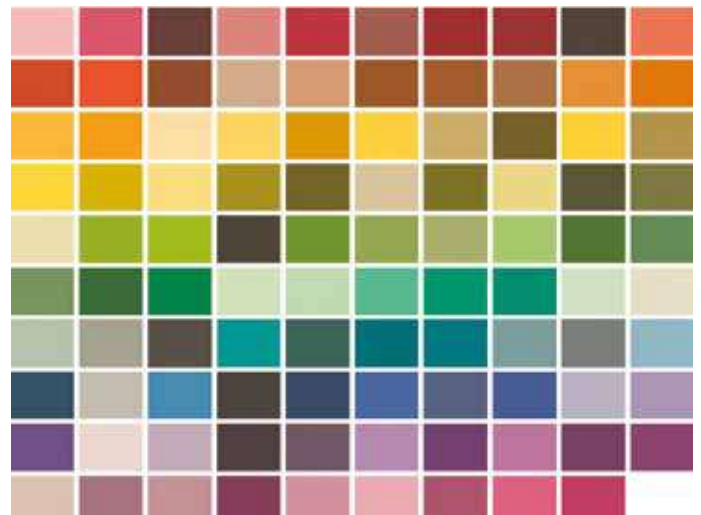

The 99 samples used to define the TM-30 are the result of a logarithmic selection obtained from the 105,000 colours visible to the human eye.



S TM-30 TEST METHOD

THE NEW ALPHABET OF LIGHT

IES TM-30 Colour Rendering Evaluation uses 99 sample colours (Colour Evaluation Samples - CES) that capture the colours of leaves, flowers, skin tones, paintings, and some original Munsell samples. The selected CESs are defined within the entire colour space, and include saturated and poorly saturated colours.

Unlike the CRI, the TM-30 proposes a metric made up of two indices, the fidelity value is max 100 and the gamut value is max 140:

- **Rf Fidelity Index**, similar to the CRI (Ra), with a maximum value of 100, which corresponds to the perfect reproduction between the samples and the reference source.
- **Rg Gamut Index**, which is inspired by the LRC Gamut Area (GAI) and calculated with reference to the dotted area in a chromatic diagram.

* IES (Illuminating Engineering Society) TM-30 15 (Technical Memorandum 30 - 2015)

** The Munsell system is a color space used as an international standard for defining colors based on three dimensional coordinates: hue, brightness (Value or Lightness) and saturation (Chroma).

Ref. www.wikipedia.org

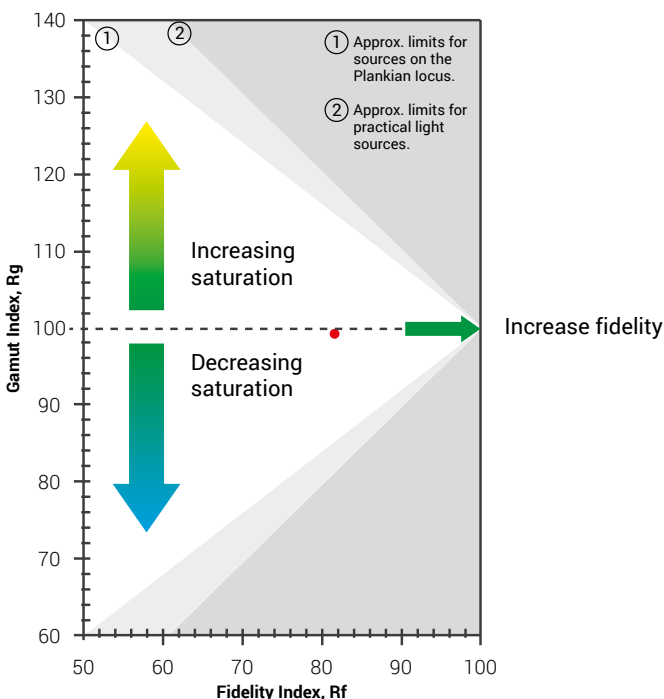

RF 92 | RG 101
CRI 98
2-step SDCM

A selection of subcurve LED with CRI 98 and efficiency of 95 lm/W, only available with CCT 3.000K.

Designed for retail environments, Saturation LEDs **bring out the colours and textures of the products** on display, enriching customers' sensorial experience.

THEY ARE THE MOST VERSATILE SOLUTION.



Dermapolis @ Seeds Gallery | London - UK

calc CCT (K)	IES TM-30		CRI	
	Rf	Rg	Ra	R9
3000 K	92	101	98	84

SPECTRAL COMPARISON

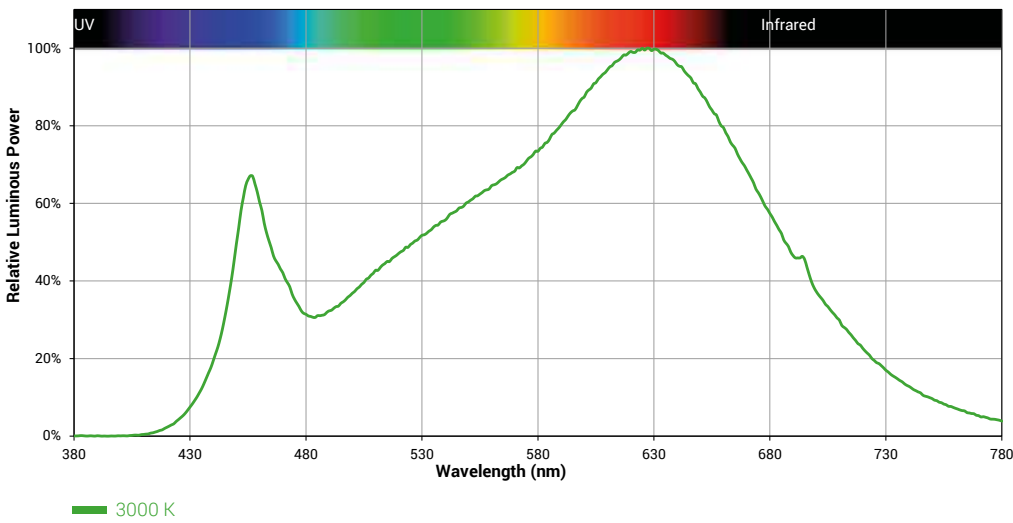

COLOR VECTOR GRAPHIC

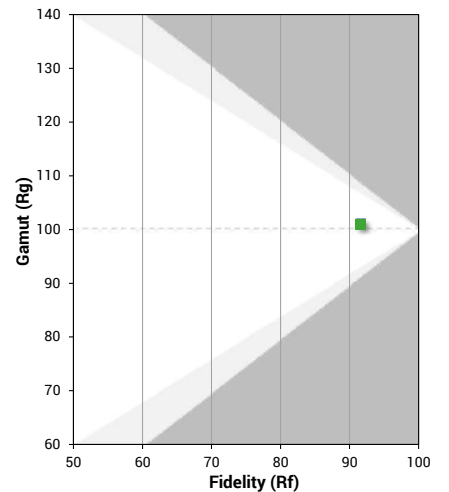
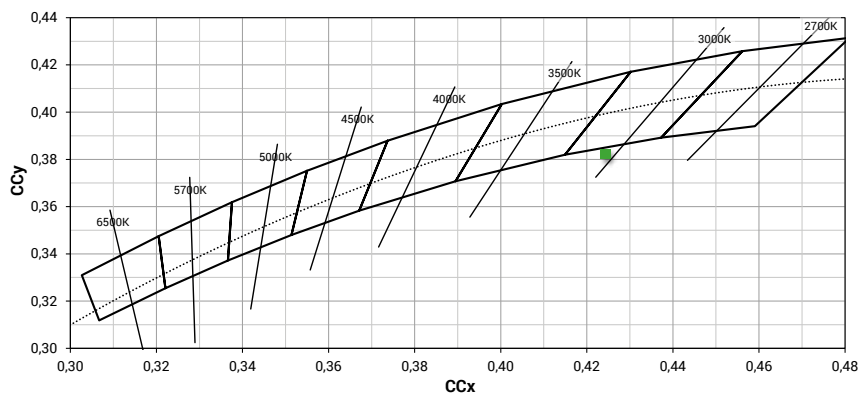
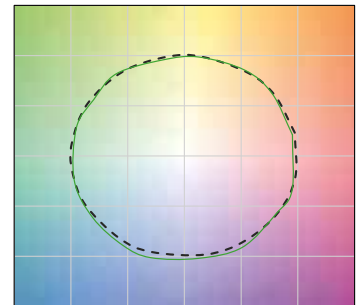

FIDELITY

RF 93 | RG 99
CRI 98
2-step SDCM

A selection of LEDs featuring the best CRI 98 colour rendering, with an efficiency of 100 lm/W, available with CCT 2.700K, 3.000K or 4.000K.

The Fidelity LEDs are designed for museums: they are generally **suitable for any situation where showing the "true" colour of the items on display is essential.**



Lora Showroom | Vicenza – Italy

calc CCT (K)	IES TM-30		CRI	
	Rf	Rg	Ra	R9
2700 K	96	101	98	93
3000 K	93	99	98	88
4000 K	91	99	98	95

SPECTRAL COMPARISON

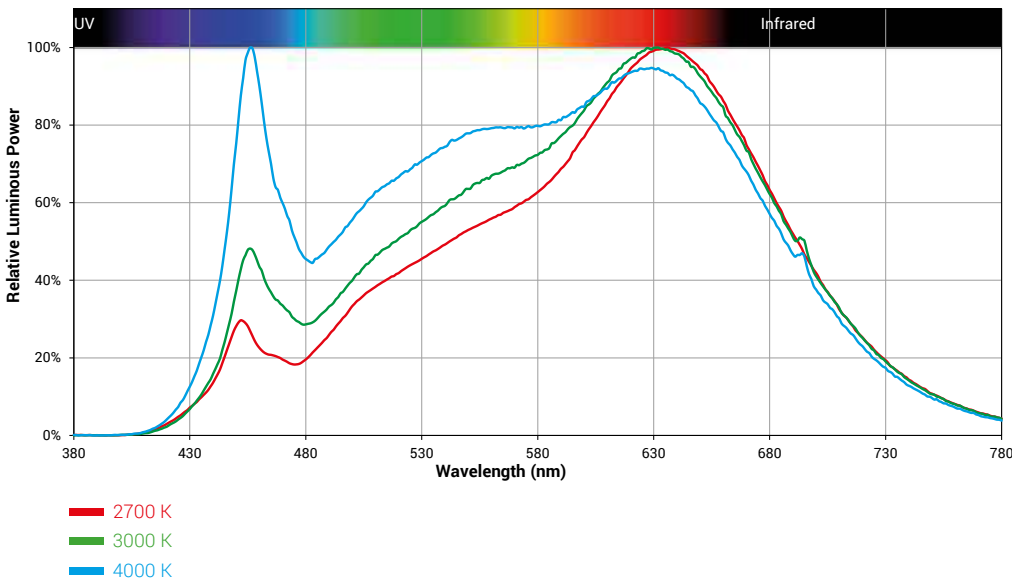

COLOR VECTOR GRAPHIC

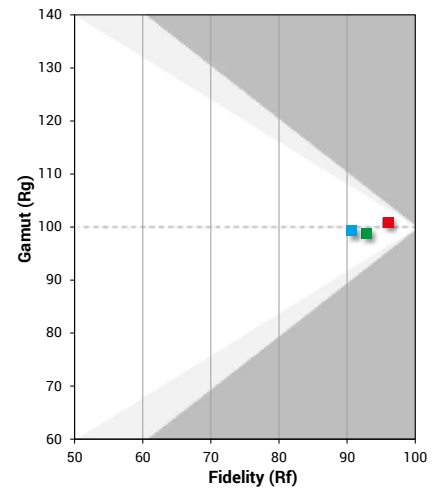
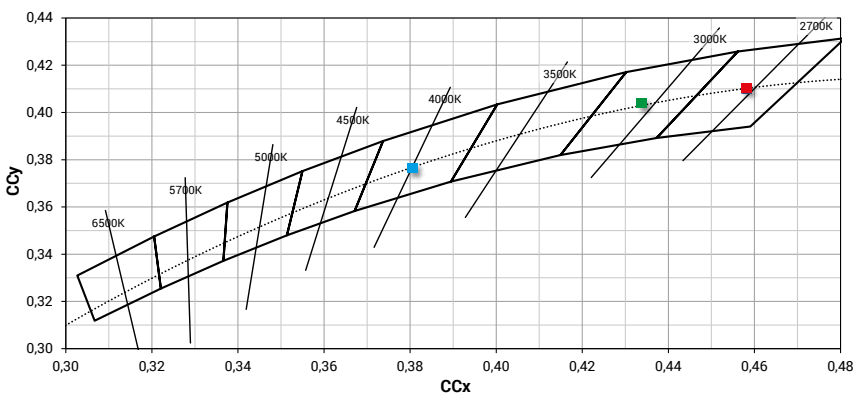
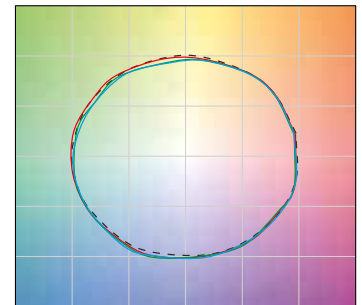

RF 92 | RG 100
CRI 92
2-step SDCM

The FullHD range is designed to ensure **a better ratio between light quality and efficiency.**

Balance LEDs have CRI 92 colour rendering and up to 115 lm/W efficiency. They are available with CCT 2.700K, 3.000K and 4.000K.



Timmis Store | Limassol – Cyprus

calc CCT (K)	IES TM-30		CRI	
	Rf	Rg	Ra	R9
2700 K	91	99	92	60
3000 K	90	100	92	56
4000 K	89	100	92	61

SPECTRAL COMPARISON

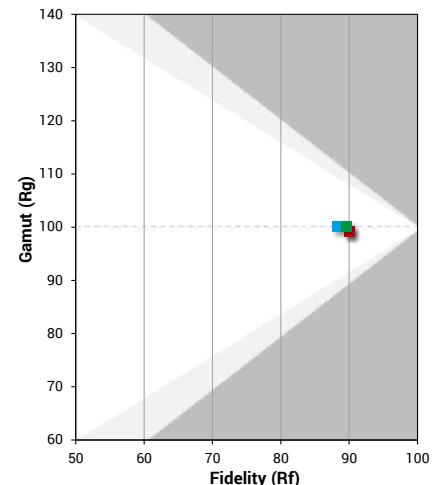
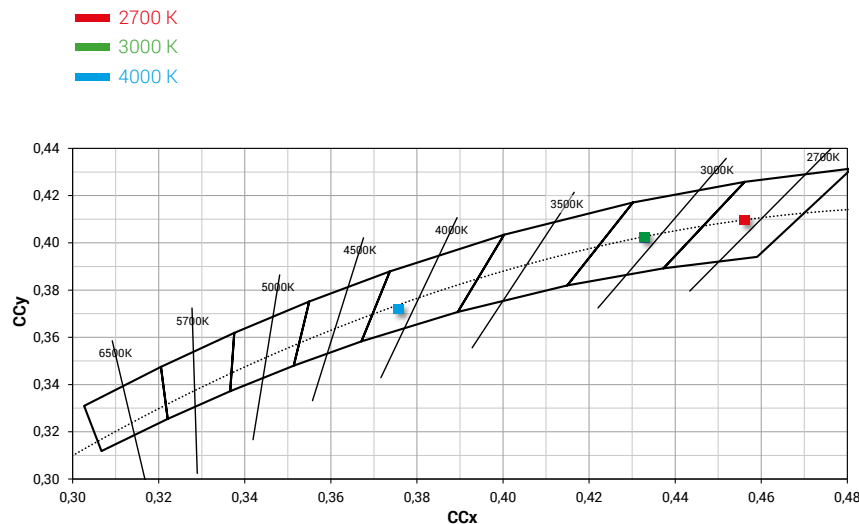
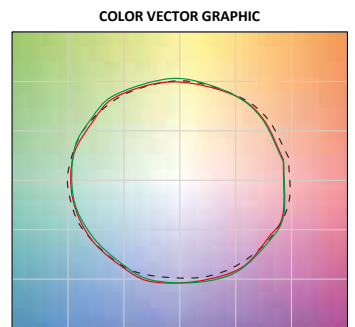
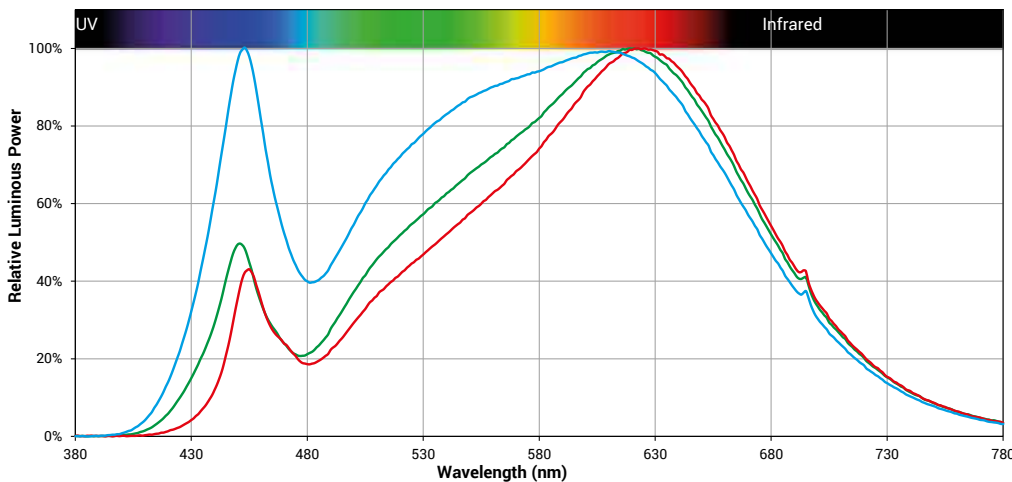

EFFICIENCY

RF 85 | RG 96
CRI 80
2-step SDCM

Our Efficiency LEDs have lower colour rendering than others, but have the **best efficiency**, up to 145 lm/W. They are available with CCT 2.700K, 3.000K and 4.000K.

They are particularly **suitable for use in public places** or spaces where there is no particular need to enhance displayed items.



Auto Ikaro | Bolzano - Italy

calc CCT (K)	IES TM-30		CRI	
	Rf	Rg	Ra	R9
2700 K	85	96	80	19
3000 K	83	96	80	10
4000 K	82	94	80	14

SPECTRAL COMPARISON

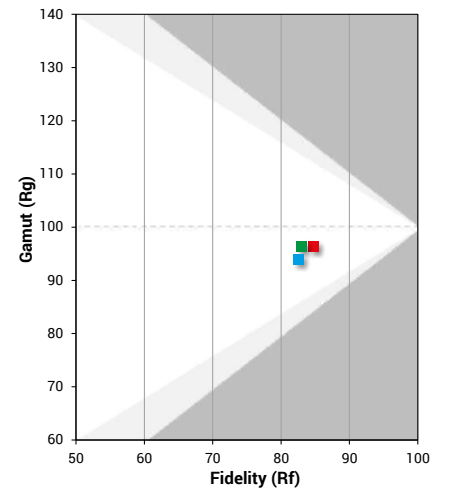
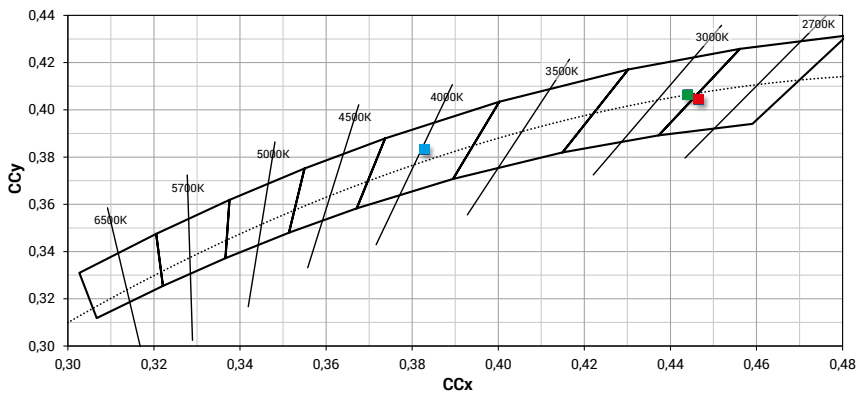
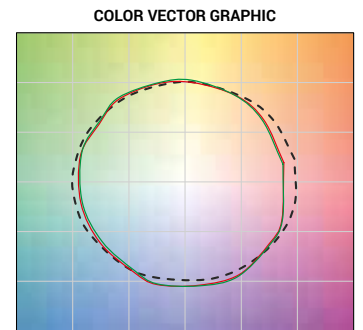
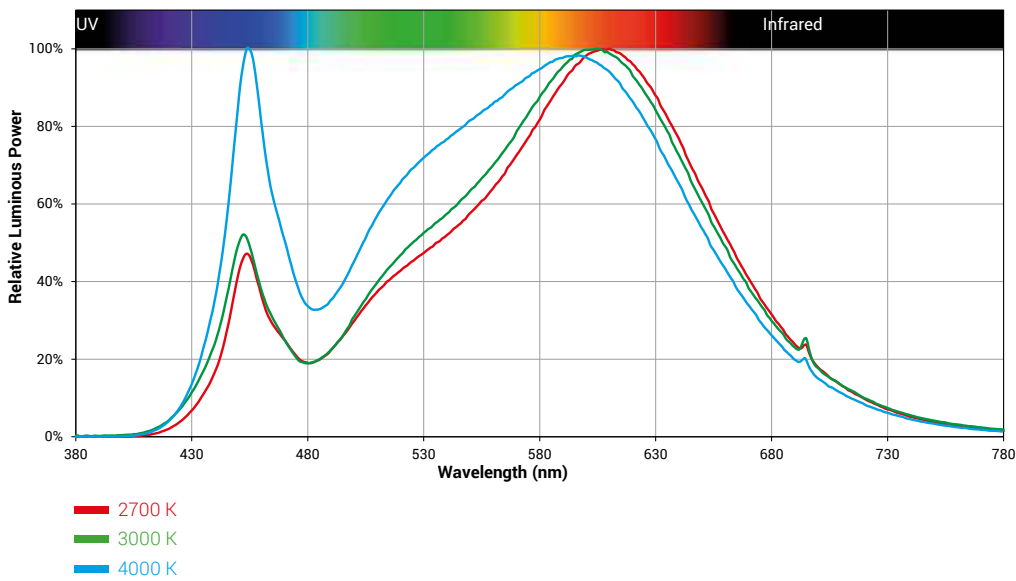





SMARTWAVE™ 4.0

LONGER LIFE GUARANTEED



SURGE
Immunity



ESD
ElectroStatic
Discharge Protection



SMARTWAVE™
LED Control-Gear



CHIP
Control-Unit

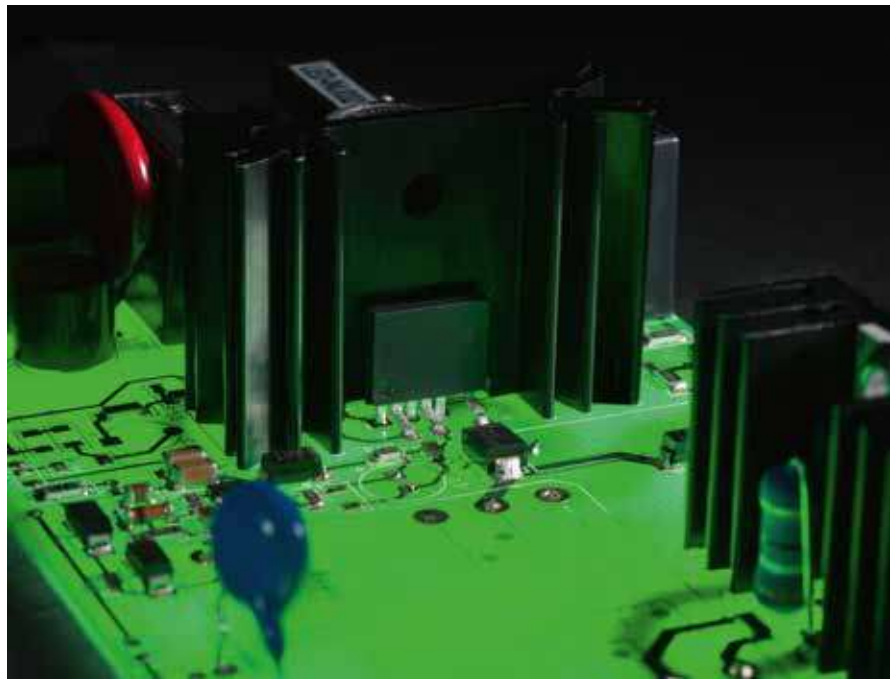

Voltage fluctuations in the power supply system can compromise the fixtures' integrity and operation. Our response to this problem is **Smartwave™**, a specially designed series of power supplies that guarantee a longer service life.

Overvoltages, or surges, can occur due to numerous phenomena, including the classic lightning strike. These phenomena are responsible for most cases of malfunction of a lighting system, especially power supplies.

Smartwave™ power supplies can work with high input voltages, **up to 7 kV, without damage: a value that exceeds seven times the minimum level of protection according to current regulations.**

Electrostatic discharges (ESDs) can irreparably damage power supplies, which are often considered the weak point of an electronic appliance in terms of safety. Smartwave™ power supplies are tested with **discharges up to 30 kV** (the IEC EN61547 indicates 4kV as the minimum value for contact discharges and 8 kV for discharges in air).

In the same way, while the legislation provides for a maximum discharge per second, Smartwave™ is tested with **five shocks per second**. Our laboratory with specialized facilities means that I-Led products are tested in-house. In addition to testing immunity from SURGE and ESD, tests are also carried out to measure the emission of electromagnetic disturbances.

ENERGY IS EFFICIENCY



L/N MAIN
180 ~ 300 V AC



SURGE
Immunity

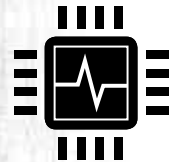
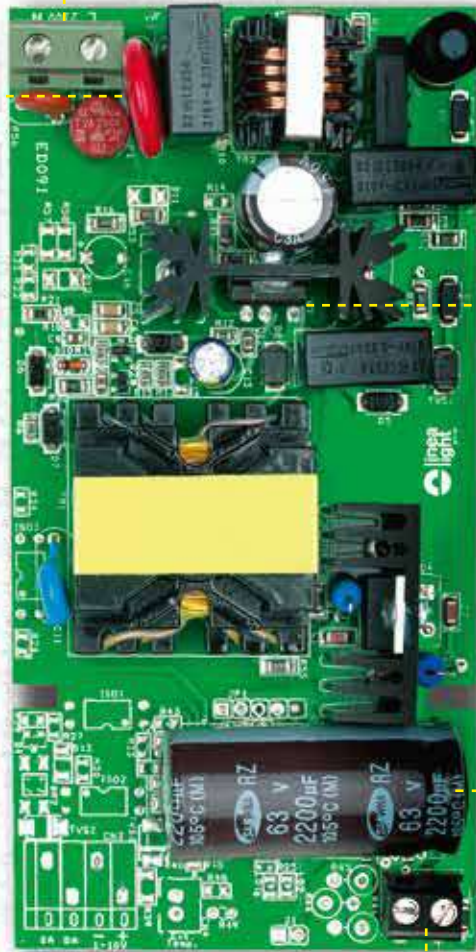

CHIP
Control-Unit

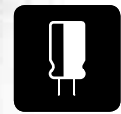

CONDENSER



OUTPUT
Lamp

TOTAL SYSTEM CONTROL AND MANAGEMENT

In the retail sector, EYE-WiFi technology allows the **management of individual light points** and the creation of groups, also in case of retrofitting.

EYE-WiFi allows the **configuration and control of the fixtures** using PC and smart devices.

EYE-WIFI

SMART LIGHTING

DIRECT CONTROL FROM THE POINT OF SALE



CONTROL BY MAINTENANCE OPERATOR



CONTROL BY THE TECHNICAL OFFICE

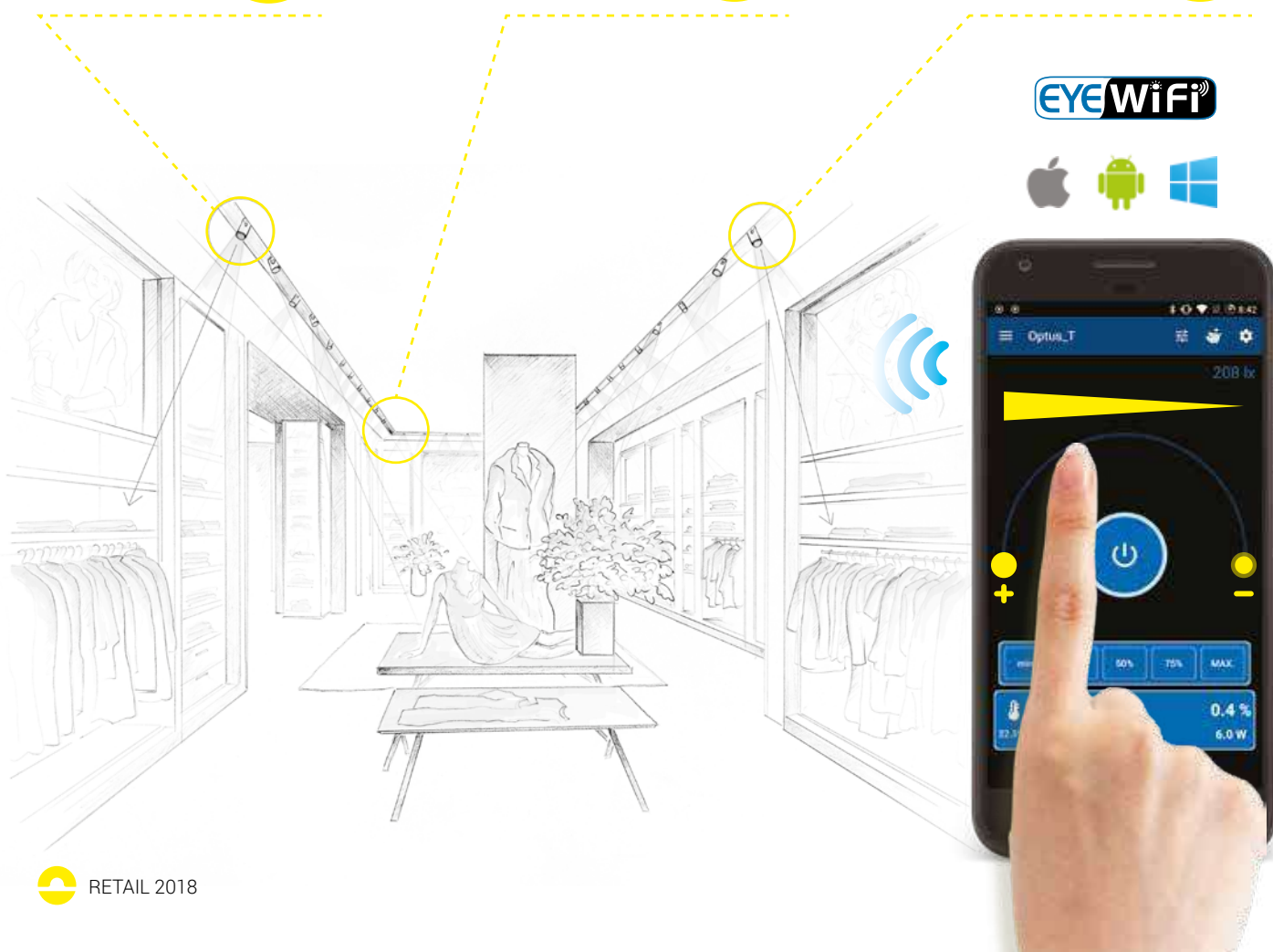

PARAMETERS FOR DIAGNOSTICS AND CONTROL OF LIGHTING FIXTURES

- Set the dimming level of the luminaire (0-100%)
- Display the lifetime (power-on) of the luminaire (DD: HH)
- View the number of ignitions during its lifetime
- View the power absorbed by the LED luminaire during its lifetime (KW/h)
- Display the instantaneous power of a single LED luminaire, of the entire system or of a single zone (W)
- Preventive maintenance

SYSTEM CONFIGURATION

- Timer service based on the RTC (Real Time Clock) function allows to set light scenarios
- Possibility to configure and manage individual lighting points and groups
- Possibility to create a maximum of 16 light scenes and a maximum of 15 light groups
- Possibility to track the passage of people and vehicles (with time of motion detection recorded)
- Network settings

SENSOR, GATEWAY AND NETWORK SETTINGS

- Adjust and view the Gateway Eye-WiFi parameters
- Adjust and view the brightness and motion detection sensor parameters



DALI

DIGITAL ADDRESSABLE LIGHTING INTERFACE

Linea Light Group has ProbitLab, a hardware platform developed to internally verify the effectiveness of programming commands, the quality of input signals and the effective correspondence of the output. Used in combination with ProbitBench, it allows to perform the homologation tests defined by the IEC 62386 standard and to distribute top-quality products with the official DALI brand.

Testing a product several times:

here's how we assure our customers an extremely reliable DALI system for digital control of lighting.



DALI Lamps registered producers and affiliated with DiiA (Digital Illumination Interface Alliance)







WE STRICTLY TEST
OUR PRODUCTS

TESTED / APPROVED



All tests are carried out internally by means of sophisticated instruments and under the control of highly qualified personnel, in compliance with current regulatory standards:

- Junction temperatures
- Photometric surveys
- Impact resilience test (ik)
- Fire resistance testing
- Salinity test
- Walk-over and drive-over resistance tests
- Protection test (ip, iec 60529 standard)
- Checking of solar radiation resistance
- Vibration and mechanical stress tests
- Climate tests

Generic tests carried out in addition to the electronic ones include:

- Test surge
- ESD test
- DALI compatibility test

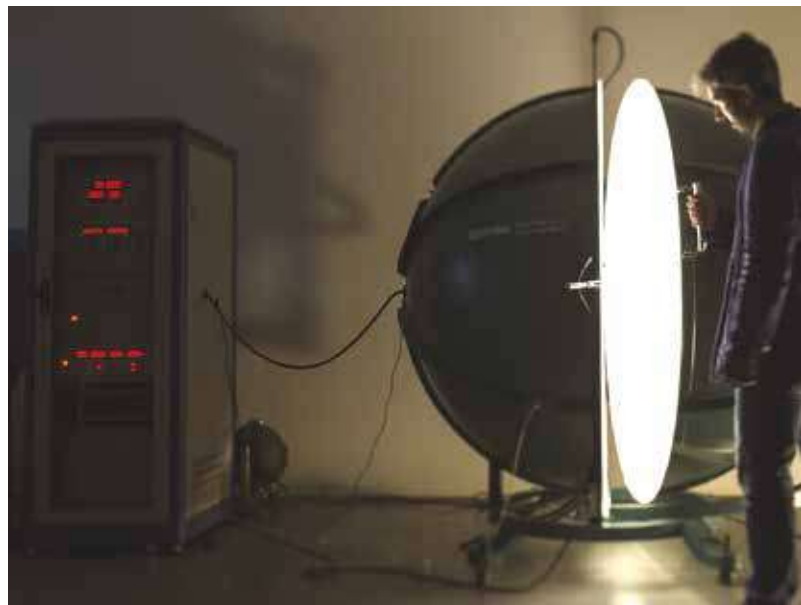

5 YEARS WARRANTY

Linea Light Group offers a five-year warranty on its products for manufacturing defects. The specific activation form to be filled is available on our website www.linealight.com

If the procedure is not activated, the guarantee provided for by the current regulation remains valid.

All products must be installed using Linea Light Group's original or certified power supply devices, cables and accessories. Products with non-original or non-certified parts are not covered by the product warranty.



PROJECTORS UNDER THE SPOTLIGHTS





projectors pound



Completely redesigned for look and performance, Pound offers a complete range of sleek track spotlights with **excellent lighting performance** and an **essential design**.

Available in four sizes, Pound can be combined with Balance - CRI 92, Specialty - CRI 98 e Fidelity - CRI 98 LEDs.

The proposed optics, Spot (15°), Medium Flood (30°) and Flood (60°), are interchangeable and can be integrated with beam and glare control Accessories.

Materials

Die-cast aluminium

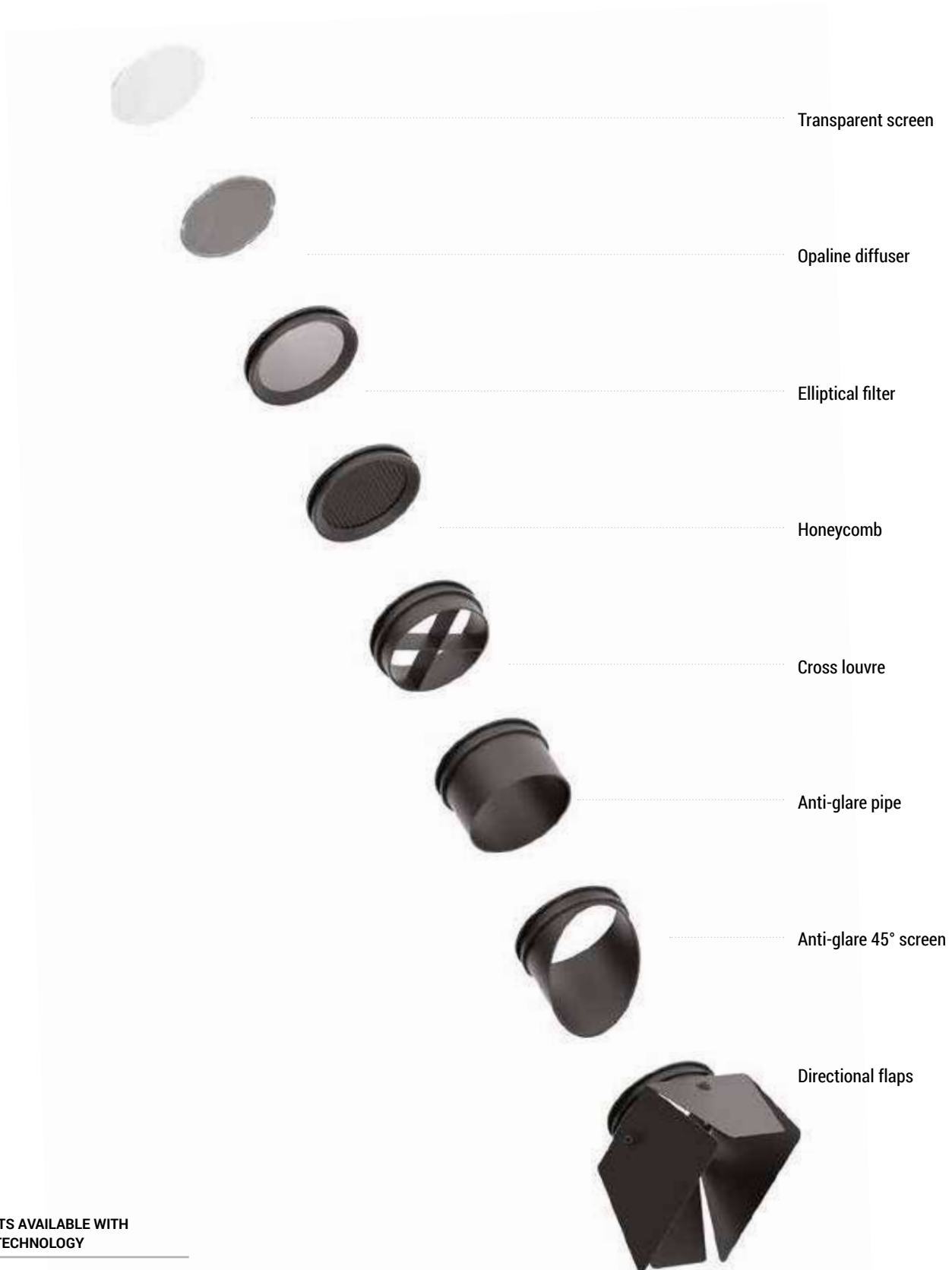

Transparent screen

Opaline diffuser

Elliptical filter

Honeycomb

Cross louvre

Anti-glare pipe

Anti-glare 45° screen

Directional flaps

SPOTLIGHTS AVAILABLE WITH EYE-WIFI TECHNOLOGY





ø 48 mm
9 W



Spot

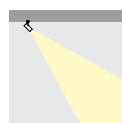

Medium Flood

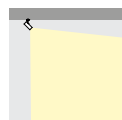

Flood

ø 65 mm
19 W

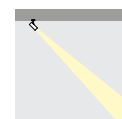

Spot

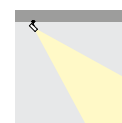

Medium Flood

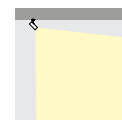

Flood



ø 85 mm
31 W



Spot

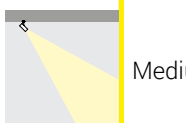

Medium Flood

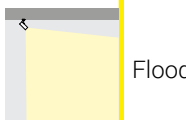

Flood

ø 100 mm
41 W / 50 W



Spot



Medium Flood



Flood

Pound_1 | Projectors | 190-250 V | 7 W powerLED | 9 W AC device

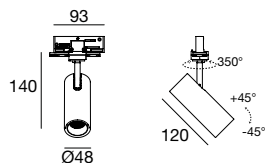

Balance - CRI 92

White	90617	3000 K	929 lm	W	Spot	15
Black	90618	4000 K	995 lm	N	Medium Flood	30
					Flood	60

TIR LENSES



99448	99449	99450
Spot	Medium Flood	Flood

ACCESSORIES



99401	99400	99399	99402	99403
Elliptical filter	Honeycomb	Cross louvre	Anti-glare pipe	Anti-glare 45° screen

Pound_2 | Projectors | 190-250 V | 16 W arrayLED | 19 W AC device

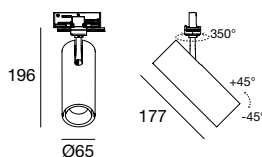

Specialty - CRI 98

White	80146	3000 K	1636 lm	W	Spot	15
Black	80147				Medium Flood	30
					Flood	60

Fidelity - CRI 98

White	80148	3000 K	1753 lm	W	Spot	15
Black	80149	4000 K	1885 lm	N	Medium Flood	30
					Flood	60

Balance - CRI 92

White	90591	3000 K	2016 lm	W	Spot	15
Black	90592	4000 K	2170 lm	N	Medium Flood	30
					Flood	60

TIR LENSES



98995	98996	98997
Spot	Medium Flood	Flood

ACCESSORIES



99656	99509	99511	99508	99512
Elliptical filter	Honeycomb	Cross louvre	Anti-glare pipe	Anti-glare 45° screen

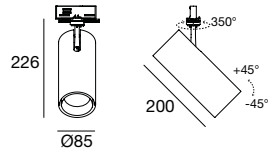

Specialty - CRI 98

White	80150	3000 K	2745 lm	W	Spot	15
Black	80151				Medium Flood	30
					Flood	60

Fidelity - CRI 98

White	80152	3000 K	2948 lm	W	Spot	15
Black	80153	4000 K	3151 lm	N	Medium Flood	30
					Flood	60

Balance - CRI 92

White	90597	3000 K	3391 lm	W	Spot	15
Black	90599	4000 K	3631 lm	N	Medium Flood	30
					Flood	60

OPTICS

99565	99566	99567	99569	99568
Spot	Medium Flood	Flood	Transparent screen	Opaline diffuser

ACCESSORIES

99513	99515	99517	99514	99518
Elliptical filter	Honeycomb	Cross louvre	Anti-glare pipe	Anti-glare 45° screen



Pound_4 | Projectors | 190-250 V | 37 W arrayLED | 41 W AC device

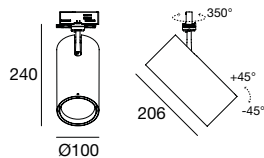

Specialty - CRI 98

White	80154	3000 K	3297 lm	W	Spot	15
Black	80155				Medium Flood	30
					Flood	60

Fidelity - CRI 98

White	80156	3000 K	3526 lm	W	Spot	15
Black	80157	4000 K	3792 lm	N	Medium Flood	30
					Flood	60

Balance - CRI 92

White	80334	3000 K	4058 lm	W	Spot	15
Black	80335	4000 K	4363 lm	N	Medium Flood	30
					Flood	60

OPTICS

98524	98525	98526	98515	98516
Spot	Medium Flood	Flood	Transparent screen	Opaline diffuser screen

ACCESSORIES

98521	98522	98520	98519	98518	98523
Elliptical filter	Honeycomb	Cross louvre	Anti-glare pipe	Anti-glare 45° screen	Directional flaps

Pound_4 DALI | Projectors | 190-250 V | 33 W arrayLED | 37 W AC device

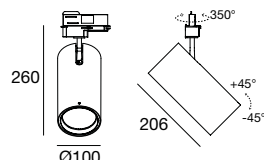

Specialty - CRI 98

White	80111	3000 K	3433 lm	W	Spot	15
Black	80112				Medium Flood	30
					Flood	60

Fidelity - CRI 98

White	80113	3000 K	3671 lm	W	Spot	15
Black	80114	4000 K	3948 lm	N	Medium Flood	30
					Flood	60

Balance - CRI 92

White	80115	3000 K	4225 lm	W	Spot	15
Black	80116	4000 K	4542 lm	N	Medium Flood	30
					Flood	60

OPTICS

98524	98525	98526	98515	98516
Spot	Medium Flood	Flood	Transparent screen	Opaline diffuser screen

ACCESSORIES

98521	98522	98520	98519	98518	98523
Elliptical filter	Honeycomb	Cross louvre	Anti-glare pipe	Anti-glare 45° screen	Directional flaps

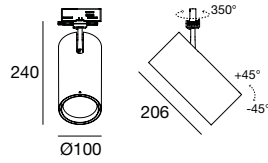

Specialty - CRI 98

White	80158	3000 K	4683 lm	W	Spot	15
Black	80159				Medium Flood	30
					Flood	60





Fidelity - CRI 98

White	80160	3000 K	4683 lm	W	Spot	15
Black	80161	4000 K	5033 lm	N	Medium Flood	30
					Flood	60

Balance - CRI 92

White	80083	3000 K	5383 lm	W	Spot	15
Black	80084	4000 K	5784 lm	N	Medium Flood	30
					Flood	60

OPTICS

				
98524	98525	98526	98515	98516
Spot	Medium Flood	Flood	Transparent screen	Opaline diffuser

ACCESSORIES

					
98521	98522	98520	98519	98518	98523
Elliptical filter	Honeycomb	Cross louvre	Anti-glare pipe	Anti-glare 45° screen	Directional flaps



DIOR



projectors angular



Highly efficient and with a **streamlined and minimalist design**, Angular is characterized by a tilting movement up to $\pm 90^\circ$. Maximum flexibility in aiming is supported by the practical goniometer for precise tilt adjustment.

Available in five sizes, Angular can be combined with Balance - CRI 92, Specialty - CRI 98 e Fidelity - CRI 98 LEDs.

Available with DALI protocol, IP44 protection or in the suspension version. The proposed optics are Spot (15°), Medium Flood (30°) and Flood (60°). They are interchangeable and can be integrated with beam and glare control accessories.

Materials

Die-cast aluminium



TRACK SPOTLIGHTS SPECIFIC FOR FOOD



Projectors available with specific LEDs for lighting meat, fish and bakery / dairy products. Go to page 110

SPOTLIGHTS AVAILABLE WITH EYE-WIFI TECHNOLOGY





ø 48 mm
9 W



Spot



Medium Flood



Flood

ø 65 mm
19 W



Spot



Medium Flood



Flood

ø 85 mm
31 W



Spot



Medium Flood



Flood



ø 100 mm
41 W / 50 W

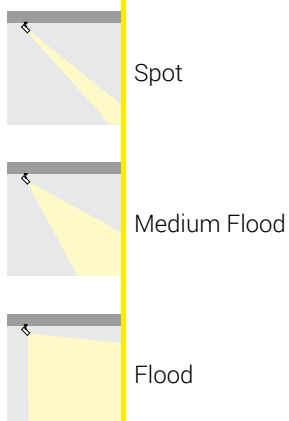

ø 140 mm
48 W / 70 W

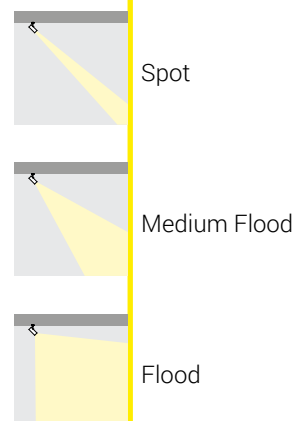

Angular_1 | Projectors | 190-250 V | 7 W powerLED | 9 W AC device

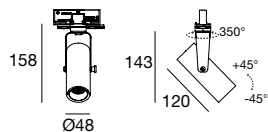

Balance - CRI 92

White	90614	2700 K	863 lm	M	Spot	15
Black	90615	3000 K	929 lm	W	Medium Flood	30
Grey	90616	4000 K	995 lm	N	Flood	60

TIR LENSES



99448	99449	99450
Spot	Medium Flood	Flood

ACCESSORIES



99401	99400	99399	99402	99403
Elliptical filter	Honeycomb	Cross louvre	Anti-glare pipe	Anti-glare 45° screen

Angular_2 | Projectors | 190-250 V | 16 W arrayLED | 19 W AC device

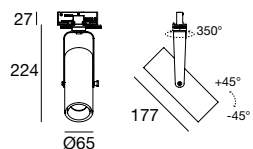

Balance - CRI 92

White	90585	2700 K	1885 lm	M	Spot	15
Black	90586	3000 K	2016 lm	W	Medium Flood	30
Grey	90587	4000 K	2170 lm	N	Flood	60

TIR LENSES



98995	98996	98997
Spot	Medium Flood	Flood

ACCESSORIES



99656	99509	99511	99508	99512
Elliptical filter	Honeycomb	Cross louvre	Anti-glare pipe	Anti-glare 45° screen

Angular_3 | Projectors | 190-250 V | 27 W arrayLED | 31 W AC device

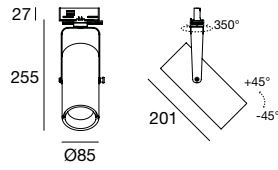

Balance - CRI 92

White	90603	2700 K	3151 lm	M	Spot	15
Black	90605	3000 K	3391 lm	W	Medium Flood	30
Grey	90604	4000 K	3631 lm	N	Flood	60

OPTICS

99565	99566	99567	99569	99568
Spot	Medium Flood	Flood	Transparent screen	Opaline diffuser

ACCESSORIES

99513	99515	99517	99514	99518
Elliptical filter	Honeycomb	Cross louvre	Anti-glare pipe	Anti-glare 45° screen

Angular40_3 | Projectors | 190-250 V | 27 W arrayLED | 31 W AC device

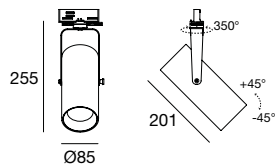

Balance - CRI 92

White	80192	2700 K	3151 lm	M	Spot	15
Black	80193	3000 K	3391 lm	W	Medium Flood	30
Grey	80194	4000 K	3631 lm	N	Flood	60

OPTICS

99565	99566	99567	99568
Spot	Medium Flood	Flood	Opaline diffuser

IP40



Angular40_4 | Projectors | 190-250 V | 37 W arrayLED | 41 W AC device

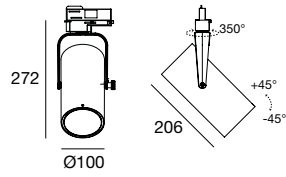

Balance - CRI 92

White	80198	2700 K	3792 lm	M	Spot	15
Black	80199	3000 K	4058 lm	W	Medium Flood	30
Grey	80200	4000 K	4363 lm	N	Flood	60

OPTICS

98524	98525	98526	98516
Spot	Medium Flood	Flood	Opaline diffuser

Environments with greater risks in case of fire due to overcrowding or prolonged evacuation time or due to high damage to animals and objects.

Angular_4 | Projectors | 190-250 V | 44 W arrayLED | 50 W AC device

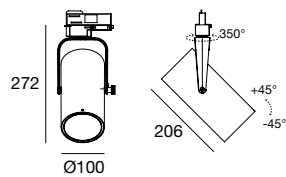

Balance - CRI 92

White	80077	2700 K	5033 lm	M	Spot	15
Black	80078	3000 K	5383 lm	W	Medium Flood	30
Grey	80079	4000 K	5784 lm	N	Flood	60

OPTICS

98524	98525	98526	98515	98516
Spot	Medium Flood	Flood	Transparent screen	Opaline diffuser

ACCESSORIES

98521	98522	98520	98519	98518	98523
Elliptical filter	Honeycomb	Cross louvre	Anti-glare pipe	Anti-glare 45° screen	Directional flaps





Angular_5 | Projectors | 190-250 V | 66 W arrayLED | 70 W AC device

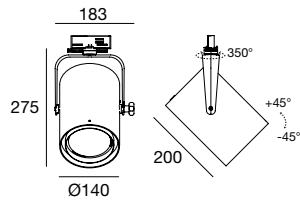

Balance - CRI 92

White	90894	2700 K	7809 lm	M	Spot	15
Black	90895	3000 K	7809 lm	W	Medium Flood	30
Grey	80127	4000 K	8982 lm	N	Flood	60

OPTICS

99408	99409	99410	99411	99527
Spot	Medium Flood	Flood	Transparent screen	Opaline diffuser screen

ACCESSORIES

98517	98511	98506	98503	98504	98505
Elliptical filter	Honeycomb	Cross louvre	Anti-glare pipe	Anti-glare 45° screen	Directional flaps

Angular_5 DALI | Projectors | 190-250 V | 41 W arrayLED | 46 W AC device

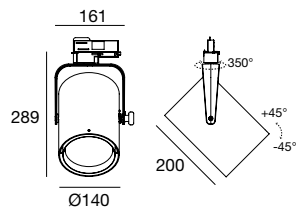

Balance - CRI 92

White	80248	2700 K	5033 lm	M	Spot	15
Black	80249	3000 K	5383 lm	W	Medium Flood	30
Grey	80250	4000 K	5784 lm	N	Flood	60

OPTICS

99408	99409	99410	99411	99527
Spot	Medium Flood	Flood	Transparent screen	Opaline diffuser screen

ACCESSORIES

98517	98511	98506	98503	98504	98505
Elliptical filter	Honeycomb	Cross louvre	Anti-glare pipe	Anti-glare 45° screen	Directional flaps



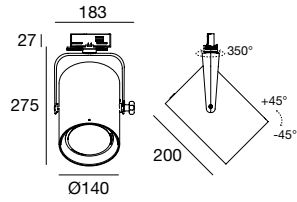

Balance - CRI 92

White	93858	2700 K	5033 lm	M	Spot	15
Black	93859	3000 K	5383 lm	W	Medium Flood	30
Grey	80129	4000 K	5784 lm	N	Flood	60

OPTICS



99408

Spot



99409

Medium Flood



99410

Flood



99527

Opaline diffuser

IP40



Available in DALI version on request

IP40

Available with IP40 protection on request



ø 100 mm
41 W AC

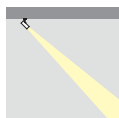

Spot

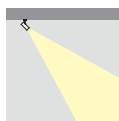

Medium Flood

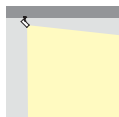

Flood

ø 140 mm
70 W AC

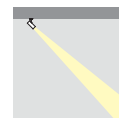

Spot

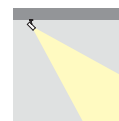

Medium Flood



Flood

Angular_P4 | Projectors | 190-250 V | 37 W arrayLED | 41 W AC device

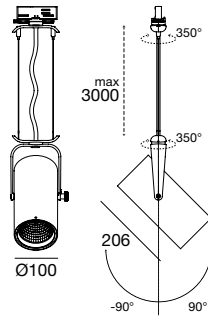

Balance - CRI 92

White	80278	2700 K	3792 lm	M	Spot	15
Black	80279	3000 K	4058 lm	W	Medium Flood	30
Grey	80280	4000 K	4363 lm	N	Flood	60

OPTICS

98524	98525	98526	98515	98516
Spot	Medium Flood	Flood	Transparent screen	Opaline diffuser screen

ACCESSORIES

98521	98522	98520	98518	98519
Elliptical filter	Honeycomb	Cross louvre	Anti-glare 45° screen	Anti-glare pipe screen

Angular_P5 | Projectors | 190-250 V | 66 W arrayLED | 70 W AC device

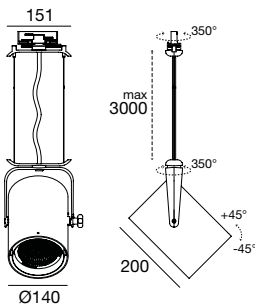

Balance - CRI 92

White	80284	2700 K	7809 lm	M	Spot	15
Black	80285	3000 K	7809 lm	W	Medium Flood	30
Grey	80286	4000 K	8982 lm	N	Flood	60

OPTICS

99408	99409	99410	99411	99527
Spot	Medium Flood	Flood	Transparent screen	Opaline diffuser screen

ACCESSORIES

98517	98511	98506	98504	98503
Elliptical filter	Honeycomb	Cross louvre	Anti-glare pipe	Anti-glare 45° screen

projectors optus_T



Optus is a new range of products designed for the retail sector: their **clean shapes** and **small sizes** can be combined with track and channel Creek spotlights, pull-out ceiling recessed luminaires, window lighting.

Optus_T is available in two sizes and can be combined with Balance, Saturation and Accuracy LEDs.

The available optics are Spot (15°), Medium Flood (30°), Flood (60°) and, only for the larger version, Wide Flood (90°). They are interchangeable and can be integrated with light and glare control accessories.

The electronics is inserted in the external compartment and can be integrated with the Eye Wi-Fi system, which allows direct control and monitoring of individual luminaires using apps on smartphones and tablets.

Materials

Die-cast aluminium

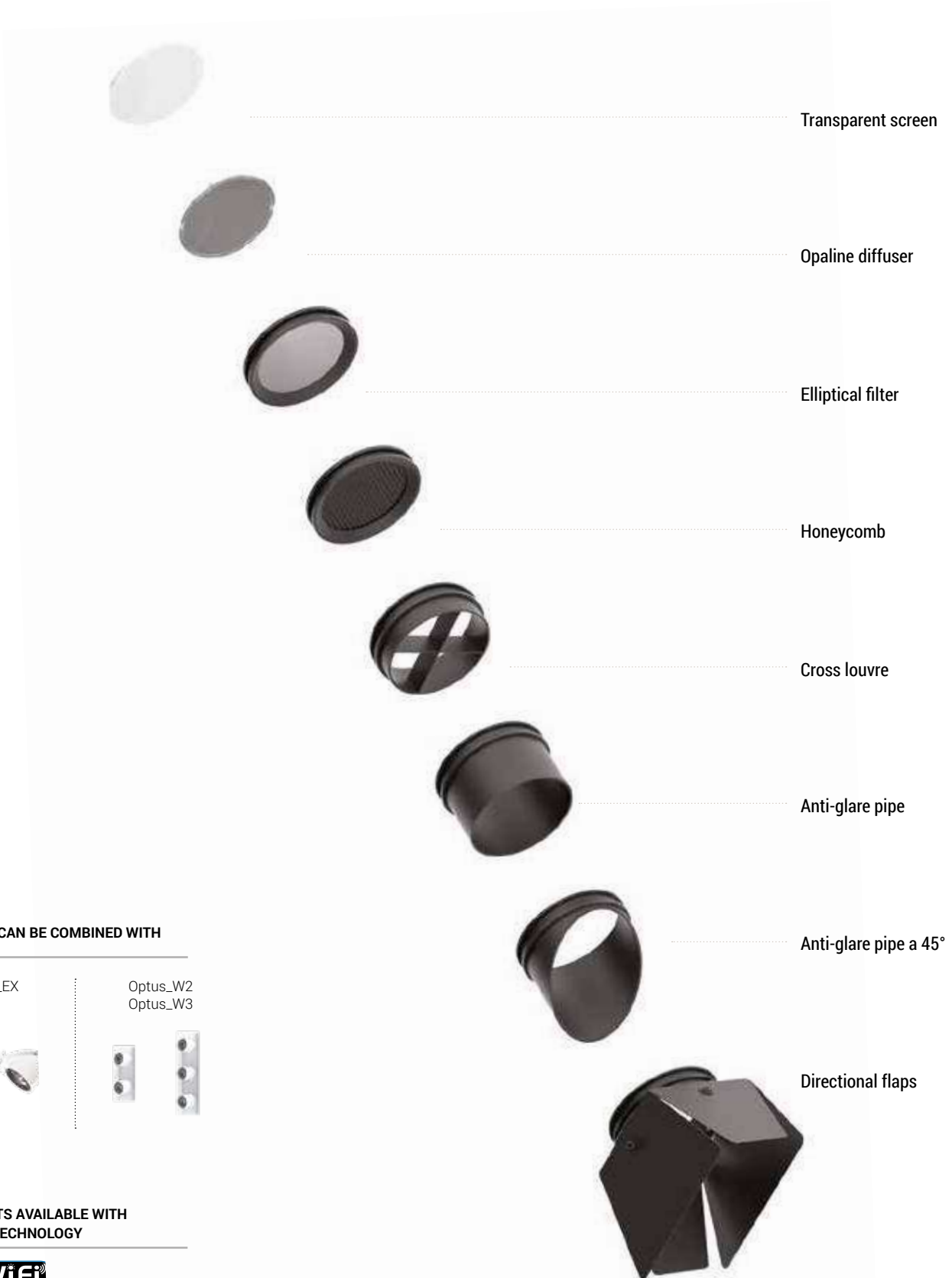

FIXTURES CAN BE COMBINED WITH

Optus_EX



Optus_W2
Optus_W3



SPOTLIGHTS AVAILABLE WITH EYE-WIFI TECHNOLOGY





ø 65 mm
21 W

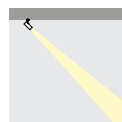

Spot

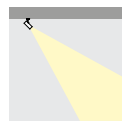

Medium Flood

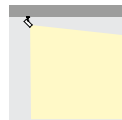

Flood

ø 102 mm
41 W

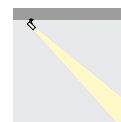

Spot

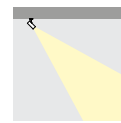

Medium Flood

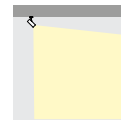

Flood



Wide Flood



ø 65 mm
22 W

EYEWiFi®

Spot

Medium Flood

Flood

The diagram shows three light beam profiles for a 65 mm fixture. The 'Spot' beam is narrow and focused. The 'Medium Flood' beam is wider and more diffused. The 'Flood' beam is the widest and most spread out.

ø 102 mm
40 W

EYEWiFi®

Spot

Medium Flood

Flood

Wide Flood

The diagram shows four light beam profiles for a 102 mm fixture. The 'Spot' beam is narrow and focused. The 'Medium Flood' beam is wider and more diffused. The 'Flood' beam is the widest and most spread out. The 'Wide Flood' beam is the widest and most spread out, covering a larger area than the other beams.

Optus_T1 | Projectors | 190-250 V | 18 W arrayLED | 21 W AC device

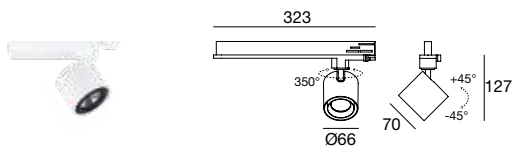

Specialty - CRI 98

White	80254	3000 K	1635 lm	W	Spot	15
Black	80255				Medium Flood	30
					Flood	60

Fidelity - CRI 98

White	80256	3000 K	1753 lm	W	Spot	15
Black	80257	4000 K	1885 lm	N	Medium Flood	30
					Flood	60

Balance - CRI 92

White	80212	3000 K	2016 lm	W	Spot	15
Black	80213	4000 K	2170 lm	N	Medium Flood	30
					Flood	60

TIR LENS



98995 Spot
98996 Medium Flood
98997 Flood

ACCESSORIES

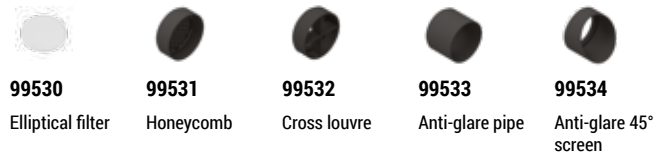

99530 Elliptical filter
99531 Honeycomb
99532 Cross louvre
99533 Anti-glare pipe
99534 Anti-glare 45° screen

Optus_T2 | Projectors | 190-250 V | 37 W arrayLED | 41 W AC device

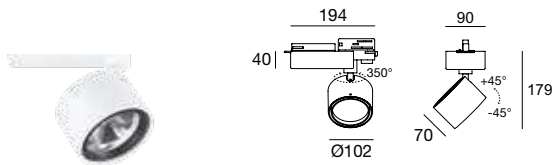

Specialty - CRI 98

White	80258	3000 K	3297 lm	W	Spot	15
Black	80259				Medium Flood	30
					Flood	60
					W. Flood	90

Fidelity - CRI 98

White	80260	3000 K	3526 lm	W	Spot	15
Black	80261	4000 K	3792 lm	N	Medium Flood	30
					Flood	60
					W. Flood	90

Balance - CRI 92

White	80166	3000 K	4058 lm	W	Spot	15
Black	80167	4000 K	4363 lm	N	Medium Flood	30
					Flood	60
					W. Flood	90

OPTICS

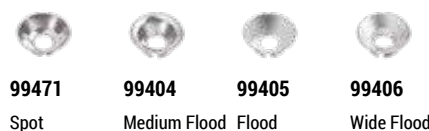

99471 Spot
99404 Medium Flood
99405 Flood
99406 Wide Flood

ACCESSORIES



99654 Elliptical filter
99655 Honeycomb
98520 Cross louvre
98519 Anti-glare pipe
98518 Anti-glare 45° screen
98523 Directional flaps

Optus_T1 EYE-WiFi | Projectors | 190-250 V | 18 W arrayLED | 22 W AC device

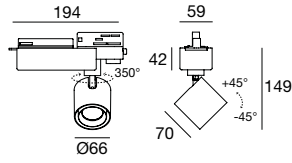

Specialty - CRI 98

White	80262	3000 K	1635 lm	W	Spot	15
Black	80263				Medium Flood	30
					Flood	60

Fidelity - CRI 98

White	80264	3000 K	1753 lm	W	Spot	15
Black	80265	4000 K	1885 lm	N	Medium Flood	30
					Flood	60

Balance - CRI 92

White	80216	3000 K	2017 lm	W	Spot	15
Black	80217	4000 K	2170 lm	N	Medium Flood	30
					Flood	60

TIR LENS



98995 Spot
98996 Medium Flood
98997 Flood

ACCESSORIES

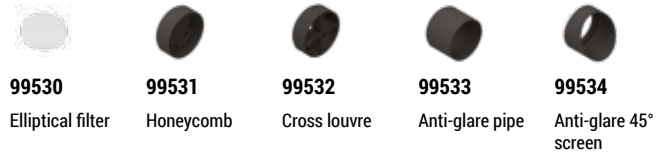

99530 Elliptical filter
99531 Honeycomb
99532 Cross louvre
99533 Anti-glare pipe
99534 Anti-glare 45° screen

Optus_T2 EYE-WiFi | Projectors | 190-250 V | 34 W arrayLED | 40 W AC device

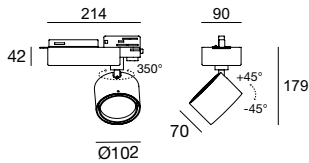

Specialty - CRI 98

White	80266	3000 K	3297 lm	W	Spot	15
Black	80267				Medium Flood	30
					Flood	60
					W. Flood	90

Fidelity - CRI 98

White	80268	3000 K	3526 lm	W	Spot	15
Black	80269	4000 K	3792 lm	N	Medium Flood	30
					Flood	60
					W. Flood	90

Balance - CRI 92

White	80170	3000 K	4058 lm	W	Spot	15
Black	80171	4000 K	4363 lm	N	Medium Flood	30
					Flood	60
					W. Flood	90

OPTICS

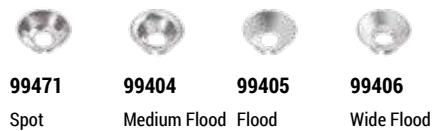

99471 Spot
99404 Medium Flood
99405 Flood
99406 Wide Flood

ACCESSORIES



99654 Elliptical filter
99655 Honeycomb
98520 Cross louvre
98519 Anti-glare pipe
98518 Anti-glare 45° screen
98523 Directional flaps

projectors iris



Iris_T is a spotlight offering **highly customizable functions**.

The focus-on-board graduated ring nut **allows calibration of the beam opening** from 19° to 62° for simple and precise aiming. **Light intensity is adjusted** through the *dim on board* selector and a potentiometer integrated in the luminaire.

Iris_T is available in four sizes and can be combined with Specialty - CRI 98 e Fidelity - CRI 98 LEDs.

Materials

Die-cast aluminium



light beam opening adjustment block

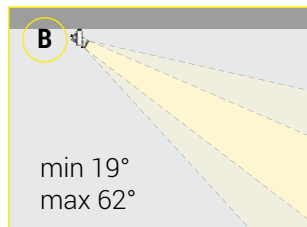

19° to 62° light beam opening

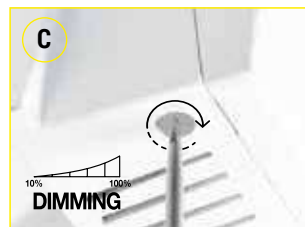

Light intensity adjustment via integrated dimmer. Light intensity can be dimmed from 10% to 100%

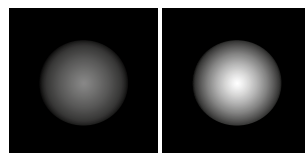
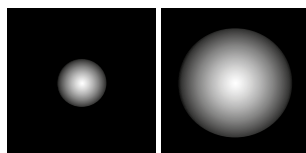



ø 40 mm
7 W AC

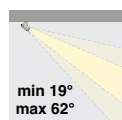

Adjustable focus

ø 60 mm
18 W AC

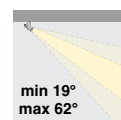

Adjustable focus



ø 80 mm
25 W AC

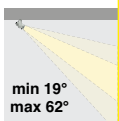

Adjustable focus

ø 100 mm
33 W AC

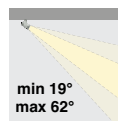

Adjustable focus

Iris_T0 | Projectors | 190-250 V | 6 W arrayLED | 7 W AC device

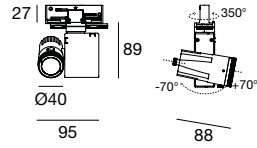

Fidelity - CRI 98

White	80424	3000 K	552 lm	W	Adjustable	85
Black	80425	4000 K	591 lm	N		

Balance - CRI 92

White	80162	3000 K	591 lm	W	Adjustable	85
Black	80163	4000 K	638 lm	N		

Iris_T1 | Projectors | 190-250 V | 15 W arrayLED | 18 W AC device

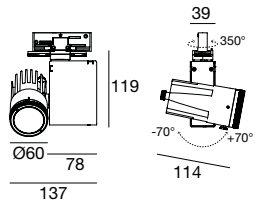

Fidelity - CRI 98

White	80426	3000 K	1458 lm	W	Adjustable	85
Black	80427	4000 K	1567 lm	N		

Balance - CRI 92

White	80272	3000 K	1677 lm	W	Adjustable	85
Black	80273	4000 K	1805 lm	N		

Iris_T2 | Projectors | 190-250 V | 21 W arrayLED | 25 W AC device

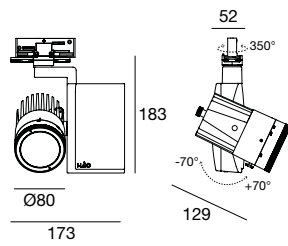

Fidelity - CRI 98

White	80428	3000 K	2364 lm	W	Adjustable	85
Black	80429	4000 K	2542 lm	N		

Balance - CRI 92

White	80306	3000 K	2721 lm	W	Adjustable	85
Black	80307	4000 K	2925 lm	N		

Iris_T3 | Projectors | 190-250 V | 29 W arrayLED | 33 W AC device

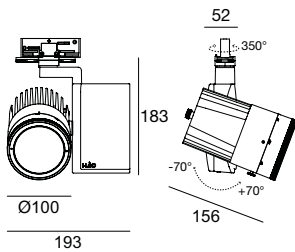

Fidelity - CRI 98

White	80430	3000 K	3030 lm	W	Adjustable	85
Black	80431	4000 K	3259 lm	N		

Balance - CRI 92

White	80310	3000 K	3488 lm	W	Adjustable	85
Black	80311	4000 K	3749 lm	N		





UPTO 50% SALE

SALE SOLDES SALDI

SALE 50% SOLDES SALDI

MCO

track system three-phase + DALI

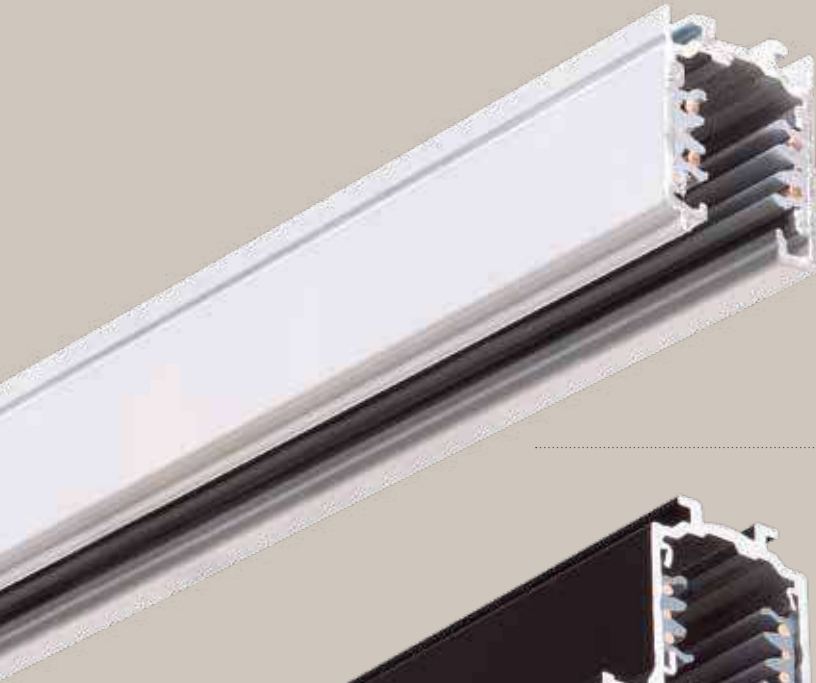

Suspension



Recessed

Epoxy powder-coated extruded aluminium electrified track. 36 x h 33 mm rectangular section with asymmetric profile for proper fitting of the modules. Four PVC insulated copper conductors with a 4 mm² cross-section (three phases and a neutral max. 16 A). Integrated 4mm² aluminium earthing conductor.

3 separate switching circuits available. Available in the recessed version with side clips for false ceiling installation. To be used with track spotlights fitted with European standard adapters.

Materials

Die-cast aluminium

TRACK SYSTEM THREE-PHASE + DALI

WIRING DIAGRAMS

The connection to a 230/250V single-phase electric power system allows a total load of 16A, which corresponds to 3680/4000 Watt that can be divided into three circuits.

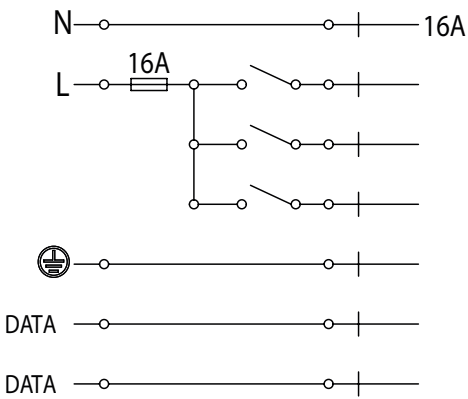

The connection to the 230/400V three-phase electric power system allows a total load of 16A, corresponding to 11040 Watt, which can be split in three circuits (3x3680 Watt).

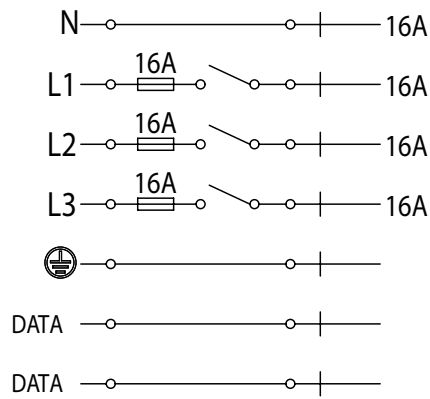

LOAD CAPACITY

The three-phase tracks can bear a load of 2kg every 200 mm with a maximum distance of 800 mm between fixing points.

With 10kg load every 200 mm, the fixing distance must be 400 mm.

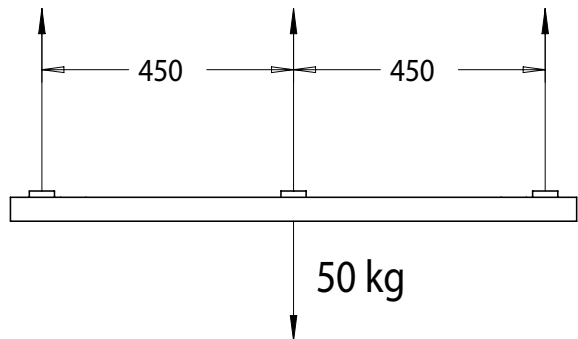
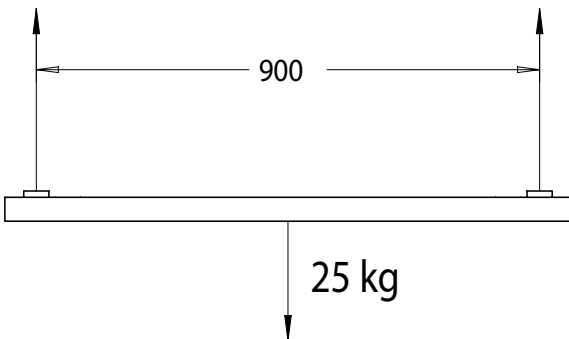

Track system | Three phases + DALI | Ceiling / Suspension

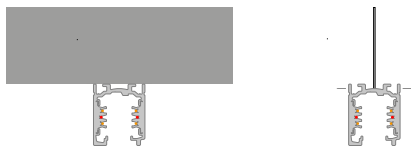

Track system | Three-phase + DALI | Recessed mounted

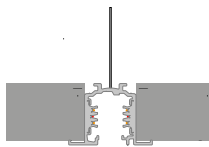

Track system | Three-phase + DALI



	1 m	2 m	3 m
White	80981	80982	80983
Black	80984	80985	80986
Grey	80987	80988	80989

Track system | Recessed track

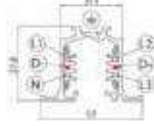

	1 m	2 m	3 m
White	80990	80991	80992
Black	80993	80994	80995
Grey	80996	80997	80998

Track system | End feed

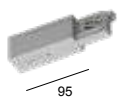

	Alim. DX	Alim. SX
White	81033	81036
Black	81034	81037
Grey	81035	81038



Track system | Jointing connector



White	81039
Black	81040
Grey	81041



Track system | Middle linear feed



White	81042
Black	81043
Grey	81044



Track system | L-feed



	Giunto INT	Giunto EST
White	81045	81048
Black	81046	81049
Grey	81047	81050



Track system | Adjustable corner



White	81066
Black	81067
Grey	81068



Track system | X-feed



White	81063
Black	81064
Grey	81065



Track system | T-feed



	EST/SX	EST/DX
White	81051	81054
Black	81052	81055
Grey	81053	81056



Track system | T-feed



	INT/SX	INT/DX
White	81057	81060
Black	81058	81061
Grey	81059	81062



Track system | End cap | Surface mounted



White	80999
Black	81000
Grey	81001

Track system | End cap | Recessed mounted



White	81002
Black	81003
Grey	81004

Track system | Suspended track with steel cable

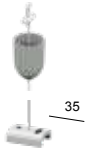

	1.5 m	5 m
White	81012	81013
Black	81014	81015
Grey	81016	81017

Track system | Suspended track with wire clamp



	1.5 m	5 m
White	81006	81007
Black	81008	81009
Grey	81010	81011

Track system | Suspended track bar M6 with cover



	1 m
White	81021
Black	81022
Grey	81023

Track system | Clamp with M6 thread gripper



White	81018
Black	81019
Grey	81020

Track system | Ceiling bracket



Anod. Al.	81086
White	81087
Black	81088

Track system | Long T-pendante bracket

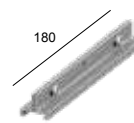

Anod. Al.	81024
White	81025
Black	81026

Track system | Recessed Cover for End feed

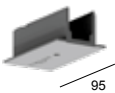

White	81069
Black	81070
Grey	81071

Track system | Recessed Cover for Middle feed

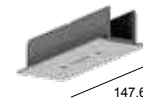

White	81072
Black	81073
Grey	81074

Track system | Recessed Cover for L-feed

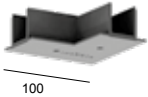

White	81075
Black	81076
Grey	81077

Track system | Recessed Cover for T-feed

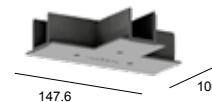

White	81078
Black	81079
Grey	81080

Track system | Recessed Cover for X-feed

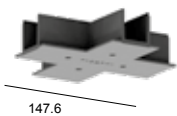

White	81081
Black	81082
Grey	81083

Track system | Gasket for End feed



White	81084
Black	81085

Track system | Single-phase + DALI base surface mounted



White	81027
Black	81028
Grey	81029

Track system | Adapter for base recessed mounted



White	81030
Black	81031
Grey	81032

Track system | 4 conductors (3-phase) adapter



White	81094
Black	81095
Grey	81096

Track system | 6 conductors (3-phase + DALI) adapter



White	81091
Black	81093
Grey	81092

Track system | Cutting tool for track conductors



Anod. Al.	81005
-----------	-------

CONTINUITY OF GROUNDING

For a correct installation of all the accessories that contribute to the composition of a three-phase track system, the continuity of the grounding line between each element is important.

As shown by the section of the track shown on our side drawing, the position of the grounding line (in red) is asymmetrical in regards to the central axis of the track; on the basis of this structural difference it is possible to distinguish the right part (which includes the grounding line) that constrains the insertion of all the accessories.

The positioning of the earth conductor must be placed between the accessory and the structure of the electrified track.

PLAN VIEW

AXONOMETRIC VIEW

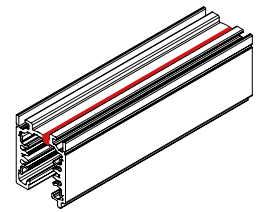
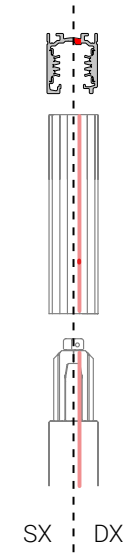

CONFIGURATION

For a correct design, we suggest to compose the structure with a plan view from above, as shown in the following drawing:

OVERHEAD VIEW

Accessories "H", "I" and "L" can be used in both directions.

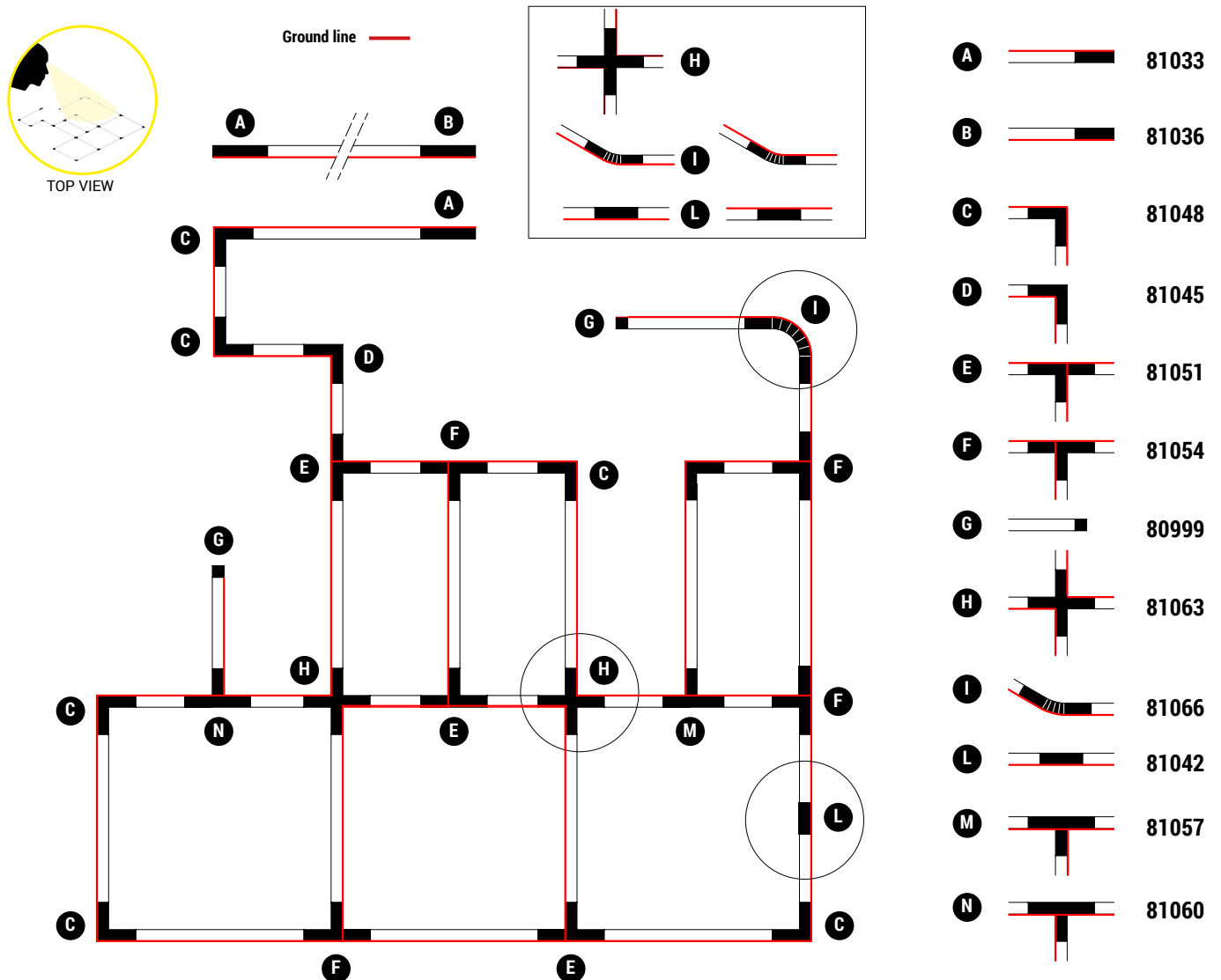



projectors optus W



Optus is a new range of products designed for the retail sector: their **clean shapes** and **small sizes** can be combined with track and channel Creek spotlights, pull-out ceiling recessed luminaires, window lighting.

Optus_W is a range of wall luminaires specifically designed for window lighting: the aluminium front carter protects the observer from dazzling, while the adjustable modules (two or three depending on the model) provide ideal lighting for the items on display.

Optus_W can be combined with Balance - CRI 92, Specialty - CRI 98 e Fidelity - CRI 98 LEDs. Available with Spot (15°), Medium Flood (30°) and Flood (60°) optics. These are interchangeable and integrated with beam and glare control accessories.

Materials

Iron sheet - die-cast aluminium

Optus-W2 | Wall luminaires | 190-250 V | 2x 15 W arrayLED | 2x 17 W AC device

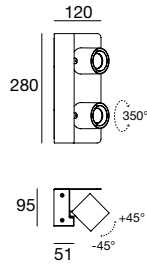

Specialty - CRI 98

White	80294	3000 K	2x 1361 lm	W	Spot	15
Black	80295				Medium Flood	30
					Flood	60

Fidelity - CRI 98

White	80296	3000 K	2x 1458 lm	W	Spot	15
Black	80297	4000 K	2x 1567 lm	N	Medium Flood	30
					Flood	60

Balance - CRI 92

White	80290	3000 K	2x 1677 lm	W	Spot	15
Black	80291	4000 K	2x 1805 lm	N	Medium Flood	30
					Flood	60

TIR LENSES

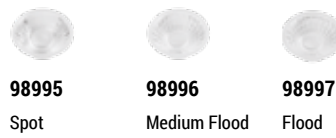

98995 Spot
98996 Medium Flood
98997 Flood

ACCESSORIES

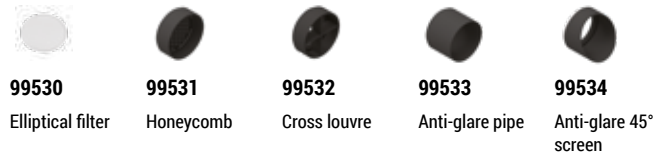

99530 Elliptical filter
99531 Honeycomb
99532 Cross louvre
99533 Anti-glare pipe
99534 Anti-glare 45° screen

Optus-W3 | Wall luminaires | 190-250 V | 3x 15 W arrayLED | 3x 17 W AC device

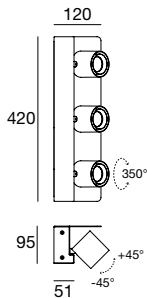

Specialty - CRI 98

White	80302	3000 K	3x 1361 lm	W	Spot	15
Black	80303				Medium Flood	30
					Flood	60

Fidelity - CRI 98

White	80304	3000 K	3x 1458 lm	W	Spot	15
Black	80305	4000 K	3x 1567 lm	N	Medium Flood	30
					Flood	60

Balance - CRI 92

White	80298	3000 K	3x 1677 lm	W	Spot	15
Black	80299	4000 K	3x 1805 lm	N	Medium Flood	30
					Flood	60

TIR LENSES

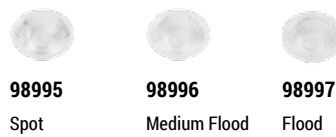

98995 Spot
98996 Medium Flood
98997 Flood

ACCESSORIES

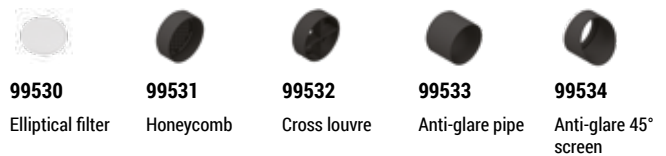

99530 Elliptical filter
99531 Honeycomb
99532 Cross louvre
99533 Anti-glare pipe
99534 Anti-glare 45° screen

spot tee



SCALE 1:1 / H 100 mm

Adjustable, the Tee window track spotlights feature **variable optics** and are available in two sizes, both fitted with Balance LEDs.

The four finishes proposed (white or black, chrome or nickel) make these small spotlights suitable for any environment; with three stem heights and various installation accessories, it can be installed on different supports.

Materials

Die-cast aluminium

A SPOTLIGHT SUITABLE FOR EVERY ENVIRONMENT

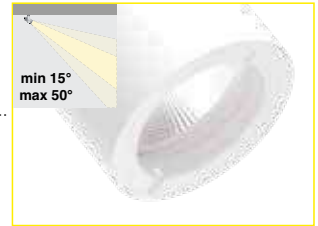

Light beam opening adjustable from 15° to 50°

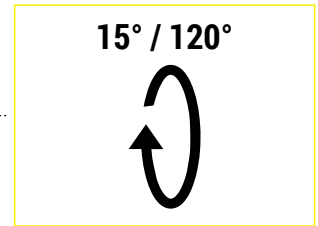

Projector angle adjustable from 15° to 120°

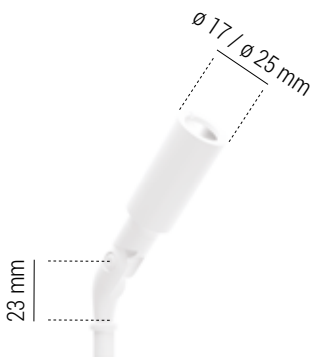

Tee_1 | Movable Spotlight | 1 W 350 mA powerLED

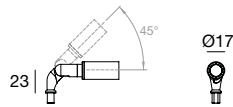

White	90503	3000 K	146 lm	W	Adjustable	85
Black	90504	4000 K	156 lm	N		
Chrome	90505	5000 K	166 lm	C		
Nickel	90506					

89144	89148	99115	99114
ON/OFF 1 - 2 art.	ON/OFF 1 - 2 art. <i>Base power supply</i>	1-10V 1 - 15 art.	DALI 1 - 15 art.

Tee_1 | Movable Spotlight | 1 W 350 mA powerLED

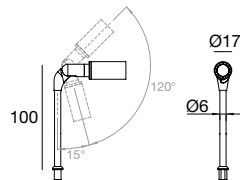

White	90499	3000 K	146 lm	W	Adjustable	85
Black	90500	4000 K	156 lm	N		
Chrome	90501	5000 K	166 lm	C		
Nickel	90502					

89144	89148	99115	99114
ON/OFF 1 - 2 art.	ON/OFF 1 - 2 art. <i>Base power supply</i>	1-10V 1 - 15 art.	DALI 1 - 15 art.

Tee_1 | Movable Spotlight | 1 W 350 mA powerLED

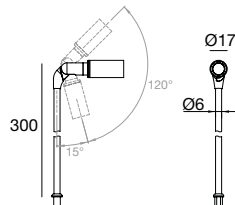

White	90495	3000 K	146 lm	W	Adjustable	85
Black	90496	4000 K	156 lm	N		
Chrome	90497	5000 K	166 lm	C		
Nickel	90498					

89144	89148	99115	99114
ON/OFF 1 - 2 art.	ON/OFF 1 - 2 art. <i>Base power supply</i>	1-10V 1 - 15 art.	DALI 1 - 15 art.

Tee_1 & Tee_2 | Accessory

White	98972
Black	98973
Chrome	98974
Nickel	98975

More info 90

White	98980
Black	98981
Chrome	98982
Nickel	98983

More info 90

White	98976
Black	98977
Chrome	98978
Nickel	98979

More info 90

White	99503
Black	99504
Chrome	99505
Nickel	99506

More info 90

Tee_2 | Movable Spotlight | 2 W 630 mA powerLED

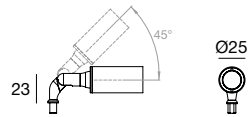

White	90515	3000 K	233 lm	W	Adjustable	85
Black	90516	4000 K	249 lm	N		
Chrome	90517	5000 K	266 lm	C		
Nickel	90518					

89147	89151	99115	99344
ON/OFF 1 - 2 art.	ON/OFF 1 - 2 art. <i>Base power supply</i>	1-10V 1 - 10 art.	DALI 1 - 12 art.

Tee_2 | Movable Spotlight | 2 W 630 mA powerLED

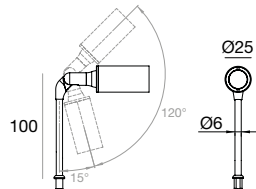

White	90511	3000 K	233 lm	W	Adjustable	85
Black	90512	4000 K	249 lm	N		
Chrome	90513	5000 K	266 lm	C		
Nickel	90514					

89147	89151	99115	99344
ON/OFF 1 - 2 art.	ON/OFF 1 - 2 art. <i>Base power supply</i>	1-10V 1 - 10 art.	DALI 1 - 12 art.

Tee_2 | Movable Spotlight | 2 W 630 mA powerLED

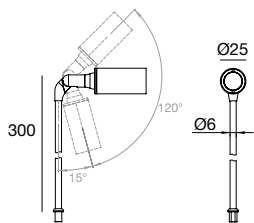

White	90507	3000 K	233 lm	W	Adjustable	85
Black	90508	4000 K	249 lm	N		
Chrome	90509	5000 K	266 lm	C		
Nickel	90510					

89147	89151	99115	99344
ON/OFF 1 - 2 art.	ON/OFF 1 - 2 art. <i>Base power supply</i>	1-10V 1 - 10 art.	DALI 1 - 12 art.

Tee_1 & Tee_2 | Accessory

	White 98972
	Black 98973
	Chrome 98974
	Nickel 98975

More info 91

	White 98980
	Black 98981
	Chrome 98982
	Nickel 98983

More info 91

	White 98976
	Black 98977
	Chrome 98978
	Nickel 98979

More info 91

	White 99503
	Black 99504
	Chrome 99505
	Nickel 99506

More info 91

Tee_1 & Tee_2 | Fixing springs for recessed mounting

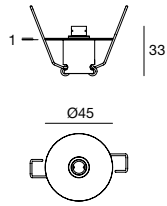

finishes available

Tee_1, Tee_2

code

White	98972
Black	98973
Chrome	98974
Nickel	98975

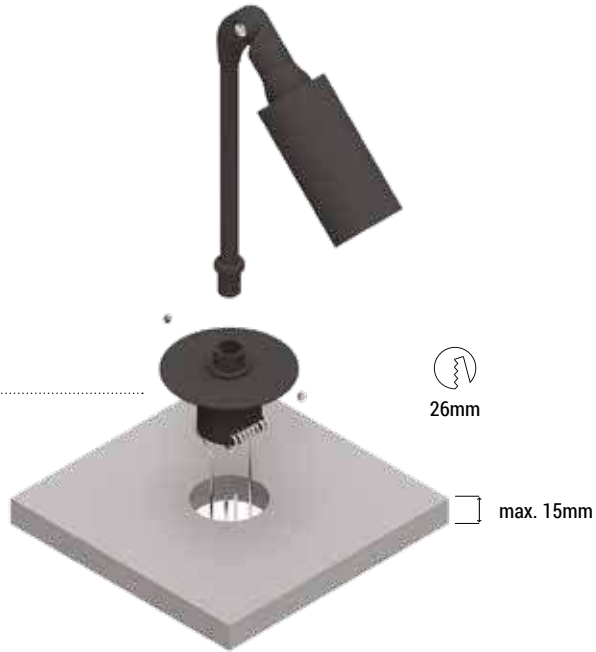

Tee_1 & Tee_2 | Threaded pins for recessed mounting

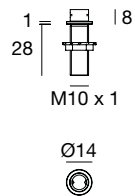

finishes available

Tee_1, Tee_2

code

White	98980
Black	98981
Chrome	98982
Nickel	98983

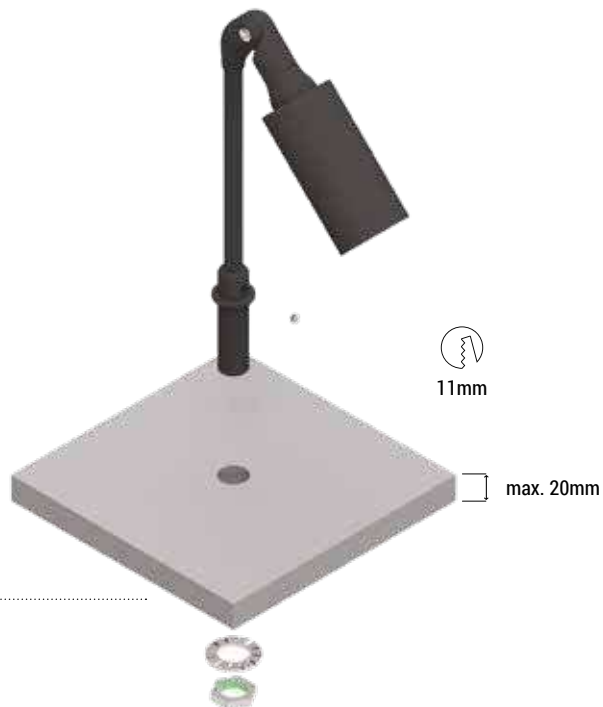
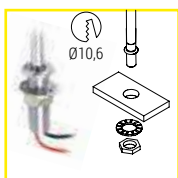

Tee_1 & Tee_2 | Fixing screws for surface mounting



finishes available

Tee_1, Tee_2

finishes available	code
White	98976
Black	98977
Chrome	98978
Nickel	98979

Tee_1 & Tee_2 | Driver holder base for ceiling mounting (driver not included)

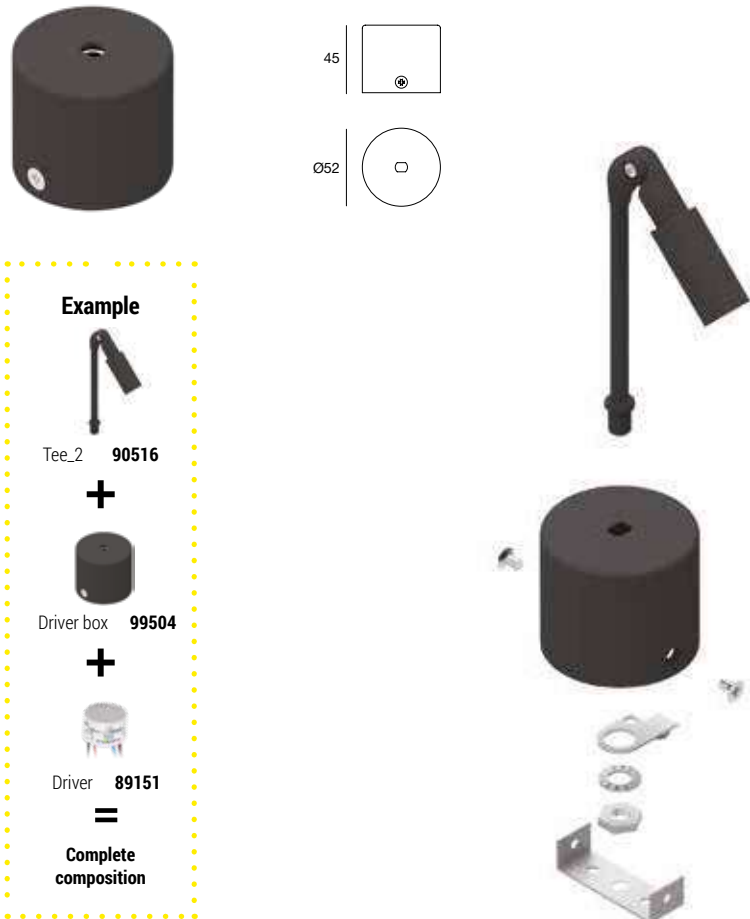

finishes available

Tee_1, Tee_2

finishes available	code
White	99503
Black	99504
Chrome	99505
Nickel	99506

Driver suitable for

Tee_1

code

89148

Tee_2

89151



Example

Tee_2 **90516**

+

Driver box **99504**

+

Driver **89151**

=

Complete composition

projectors creek



Without an external frame, Creek allows the installation of highly flexible professional lighting solutions. Its ingenious installation system facilitates mounting of the fixtures to the structure in the false ceiling (carter and track spotlights) without tools, and in a few simple steps.

Creek is the ideal choice for any retailer who wants to create an atmosphere that fits with his concept of visual merchandising. Its winning features are freedom of application and discreet blending with the surrounding space.

Materials
Aluminium





ø 48 mm
11 W AC

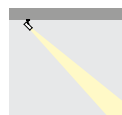

Spot

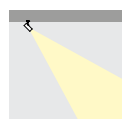

Medium Flood



Flood

ø 65 mm
15 W AC



Spot

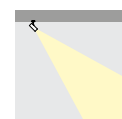

Medium Flood



Flood



85 mm



85 mm

ø 60 mm
15 W AC

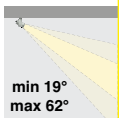

Adjustable focus

ø 80 mm
27 W AC

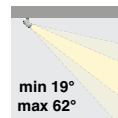

Adjustable focus

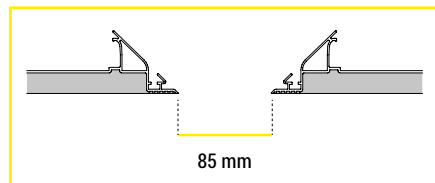

Creek Pound_1 | System_85 - System_130 | 190-250 V | 9 W arrayLED | 11 W AC device

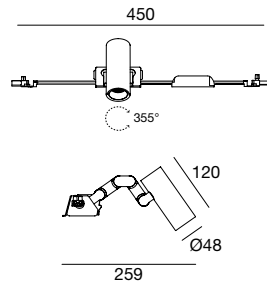

Balance - CRI 92

White	80174	3000 K	929 lm	W	Spot	15
Black	80175	4000 K	995 lm	N	M. Flood	30
					Flood	60

TIR LENSES

99448	99449	99450
Spot	Medium Flood	Flood

ACCESSORIES

99401	99400	99399	99402	99403
Elliptical filter	Honeycomb	Cross louvre	Anti-glare pipe	Anti-glare 45° screen

Creek Optus_1 | System_85 - System_130 | 190-250 V | 14 W arrayLED | 15 W AC device

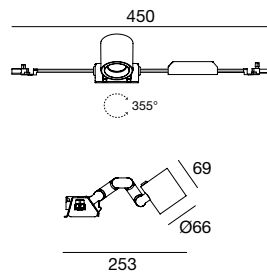

Specialty - CRI 98

White	80270	3000 K	1361 lm	W	Spot	15
Black	80271				M. Flood	30
					Flood	60

Balance - CRI 92

White	80178	3000 K	1677 lm	W	Spot	15
Black	80179	4000 K	1805 lm	N	M. Flood	30
					Flood	60

TIR LENSES

98995	98996	98997
Spot	Medium Flood	Flood

ACCESSORIES

99530	99531	99532	99533	99534
Elliptical filter	Honeycomb	Cross louvre	Anti-glare pipe	Anti-glare 45° screen

Creek Iris_1 | System_85 - System_130 | 190-250 V | 14 W arrayLED | 15 W AC device

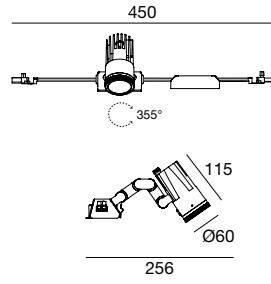

Balance - CRI 92

White	80093	3000 K	1677 lm	W	Adjustable	85
Black	80094	4000 K	1805 lm	N		

Creek Iris_2 | System_85 - System_130 | 190-250 V | 25 W arrayLED | 27 W AC device

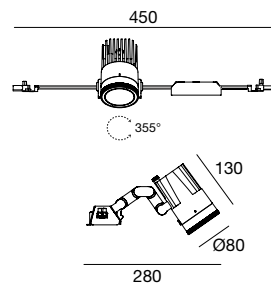

Balance - CRI 92

White	80097	3000 K	2794 lm	W	Adjustable	85
Black	80098	4000 K	2990 lm	N		

_85



ø 48 mm
11 W AC

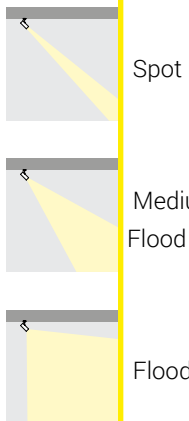

ø 65 mm
15 W AC

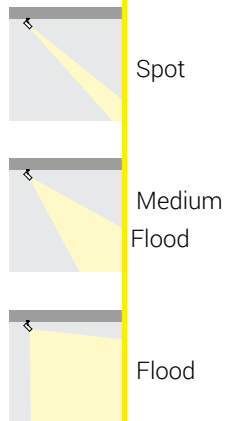

ø 60 mm
15 W AC

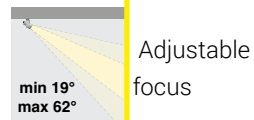

ø 80 mm
27 W AC

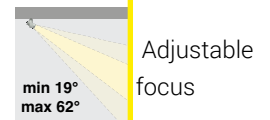



130 mm



130 mm

ø 103 mm
41 W AC

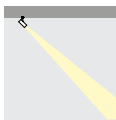

Spot

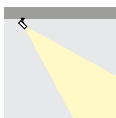

Medium Flood

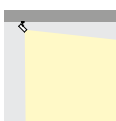

Flood

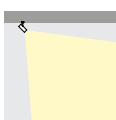

Wide Flood

ø 100 mm
41 W AC

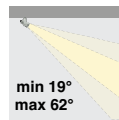

Adjustable focus

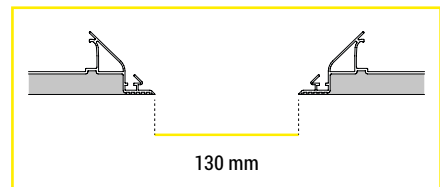

130 mm

Creek Optus_2 | System_130 | 190-250 V | 37 W arrayLED | 41 W AC device

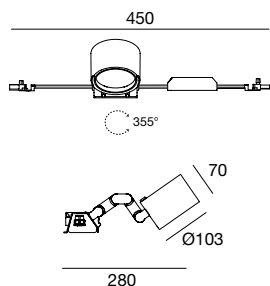

Specialty - CRI 98

White	80420	3000 K	3297 lm	W	Spot	15
Black	80421				M. Flood	30
					Flood	60
					W. Flood	90

Balance - CRI 92

White	80182	3000 K	4058 lm	W	Spot	15
Black	80183	4000 K	4363 lm	N	M. Flood	30
					Flood	60
					W. Flood	90

OPTICS

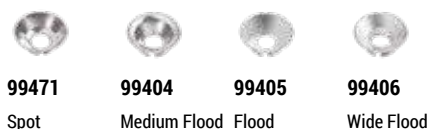

ACCESSORIES



Creek Iris_3 | System_130 | 190-250 V | 37 W arrayLED | 41 W AC device

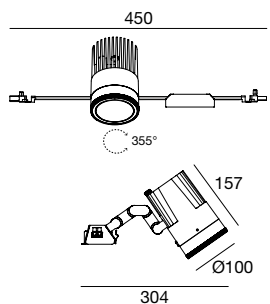

Balance - CRI 92

White	80101	3000 K	4022 lm	W	Adjustable	85
Black	80102	4000 K	4323 lm	N		

_130



INTEGRATED ARCHITECTURE SOLUTIONS

- 1 | End carter
- 2 | Fixing linear brackets
- 3 | Linear profiles (900 mm)
- 4 | L-shaped carter
- 5 | Linear profiles (300 mm)
- 6 | Carter joint
- 7 | Linear carter (300 mm)
- 8 | Linear carter (600 mm)
- 9 | Linear carter (900 mm)

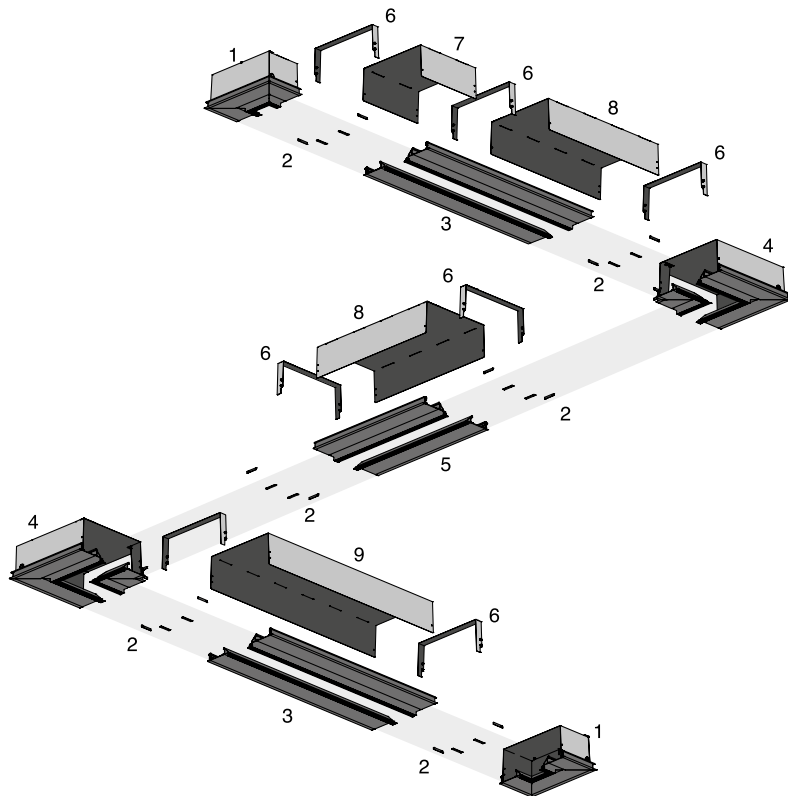

MAIN FEATURES



The track spotlights are powered by a single line, regardless of their number.



Six different luminaires available, depending on lighting requirements.

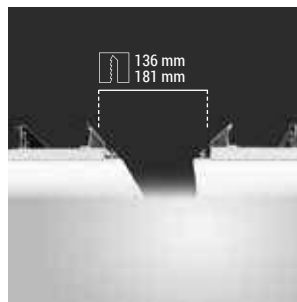

The structure is assembled depending on the size of the false ceiling.



"PLUG & PLAY" connection with wired power supply.

STEP 1

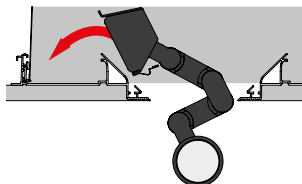

Once the structure has been set up in the false ceiling, the swing arm is inserted: the lighting fixture is at one end and the fixing base at the other end.

STEP 2

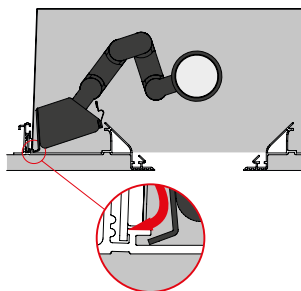

Fixing is carried out through snap-fit mounting, by inserting the base end in the profile inner seat.

STEP 3

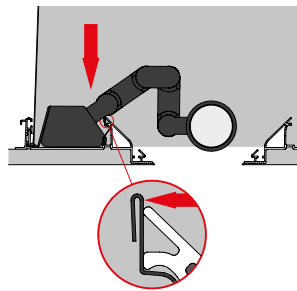

The process is completed by pressing down the base near the point where the swing arm is inserted.

STEP 4

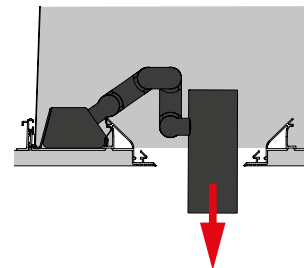

The lighting fixture is ready to be extracted and pointed. It may also be moved along the structure by pressing two flaps and sliding the fixing base.

Carter Linear_P (couple)



type	L mm	
Black	600	64307
White	600	64306
Black	900	64317
White	900	64316
Black	1800	64327
White	1800	64326
Black	3000	64337
White	3000	64336

Carter Fixing brackets

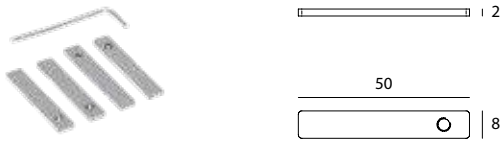

type	
Grey	64390

Cable Power Supply

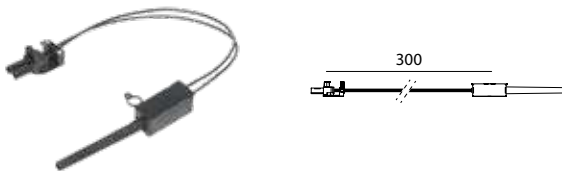

type	
Black	64391

Extension cable Extension kit

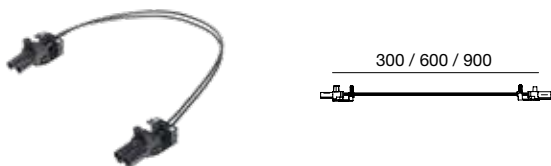

type	L mm	
Black	300	64392
Black	600	64393
Black	900	64394

Top Carter System_85 Linear_C

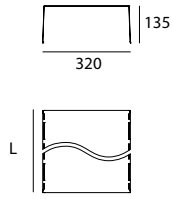

type	L mm	
Black	300	64407
White	300	64408
Black	600	64417
White	600	64418
Black	900	64427
White	900	64428

Carter System_85 End_C

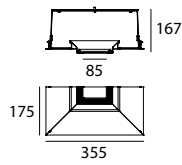

type	
Black	64437
White	64438

Carter System 90° with cover_85 L-Shaped_C

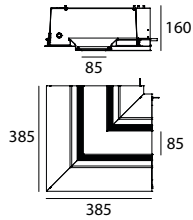

type	
Black	64447
White	64448

Dimming C-junction between the carter _85

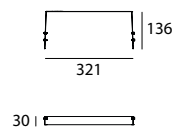

type	
Black	64467
White	64468

_85

Top Carter System_130 Linear_C

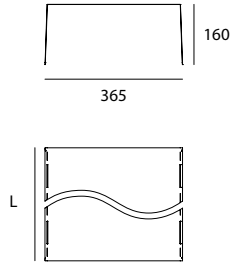

type	L mm	
Black	300	64347
White	300	64346
Black	600	64357
White	600	64356
Black	900	64367
White	900	64366

Carter System_130 End_C

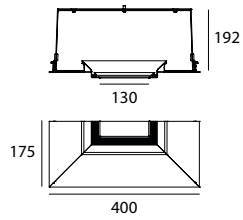

type	
Black	64377
White	64376

Carter System 90° with cover_130 L-Shaped_C

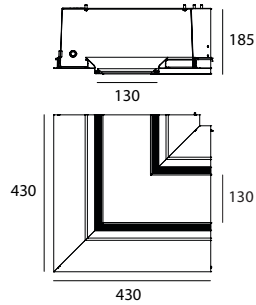

type	
Black	64387
White	64386

Dimming C-junction between the carter _130

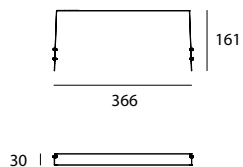

type	
Black	64457
White	64458

_130





large scale distribution fresh food



The great influence that professional lighting can have on customers' impressions is often overlooked by traders. Used in a skilful way, lighting can be very profitable, especially in supermarkets and food stores (bakeries, butcher shops, greengrocers, ...). There are indeed many benefits that can be drawn from LED lighting specially designed for food displays.



SPECIFIC TRACK SPOTLIGHTS FOR FOOD DISPLAYS

FRESH

The right lighting system increases sales and directs customers' attention to quality rather than to price. Naturally, protection against heat and ultraviolet rays is essential. Specially designed LEDs that can reduce radiation to a minimum and are specific for each type of food (meat, fish and bread) are the best solution for this purpose.

- EXCELLENT COLOUR RENDERING
- VERY LOW UV RAYS EMISSION
- COLOUR TEMPERATURE (K)
- DEDICATED EMISSION SPECTRUM
- HIGH ENERGY SAVING

Interspar | Conegliano — Italy



6500K

H FOOD

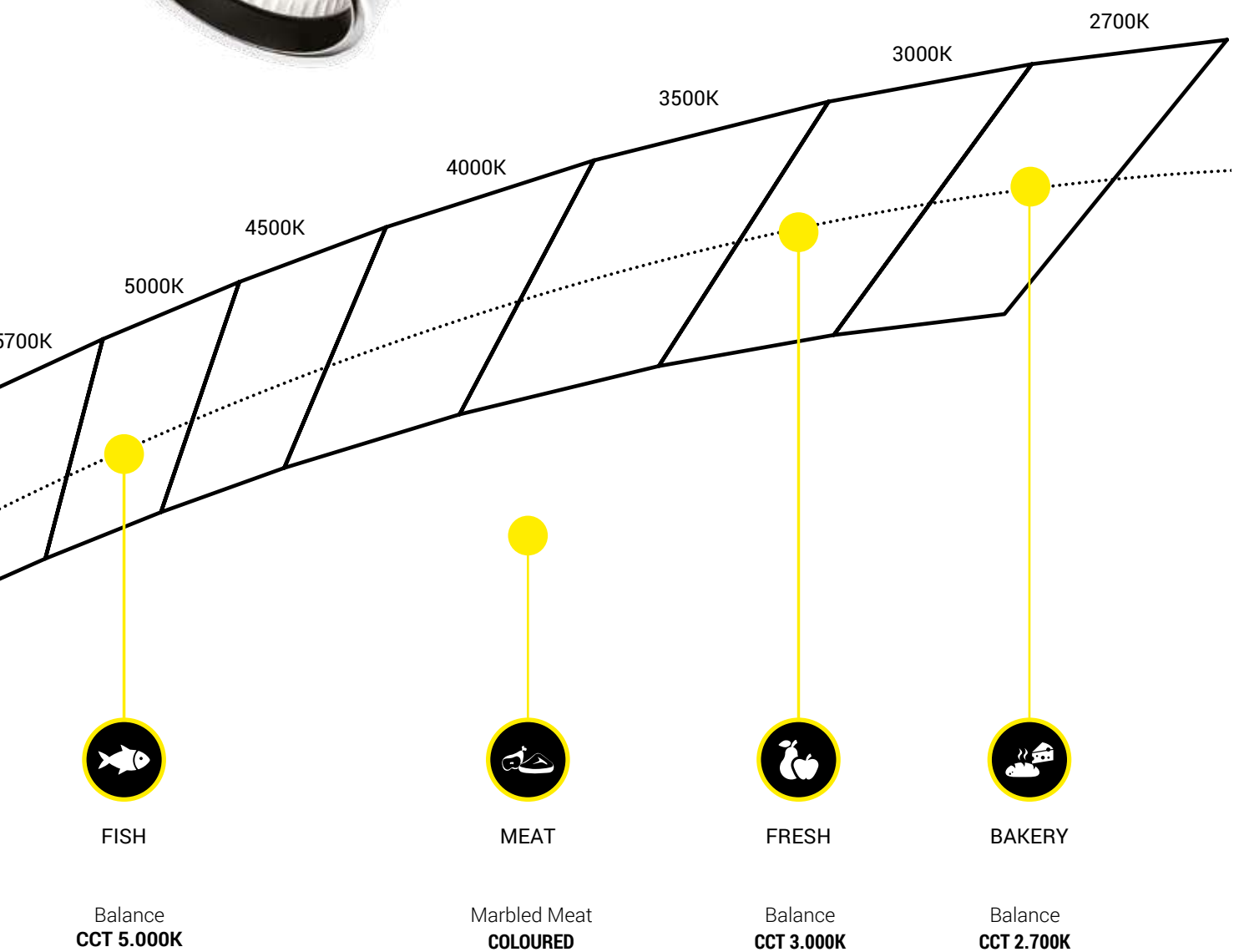

Angular_4 | Projectors | 190-250 V | 37 W arrayLED | 41 W AC device

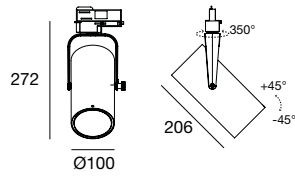

Balance - CRI 92

White	80121	Fish	5000 K	4667 lm	C	Spot	15
Black	80122	Meat		3847 lm	F	M. Flood	30
Grey	80123	Fresh	3000 K	4058 lm	W	Flood	60
		Bakery	2700 K	3792 lm	M		

TIR LENSES

98524	98525	98526	98515	99516
Spot	Medium Flood	Flood	Transparent screen	Opaline diffuser

ACCESSORIES

99654	99655	98520	98519	98518	98523
Elliptical filter	Honeycomb	Cross louvre	Anti-glare pipe	Anti-glare 45° screen	Directional flaps

Optus_EX2 | Downlight | 35 W 950 mA arrayLED

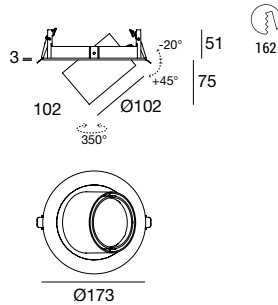

Balance - CRI 92

White	80232	Fish	5000 K	4667 lm	C	Spot	15
Black	80233	Meat		3847 lm	F	Medium Flood	30
		Fresh	3000 K	4058 lm	W	Flood	60
		Bakery	2700 K	3792 lm	M	Wide	90

OPTICS

99471	99404	99405	99406
Spot	Medium Fl.	Flood	Wide Flood

ELECTRONICS

99239	99241	99345	99355
ON/OFF 1 art.	1-10V DALI 1 art.	DALI 1 art.	EMERGENCY 1 art. 226

ACCESSORIES

99479	98520	99654	99655	98519	98518	98523
Kicker	Cross louvre	Elliptical filter	Honeycomb	Anti-glare pipe	Anti-glare 45° screen	Directional flaps



FISH - 5000K



All food contained in refrigerators and freezers gain freshness with a very white light. The cold colours have a strong emotional effect: freshness and storage capacity are estimate intuitively better in environments that appear cold.

Light for fish and frozen foods

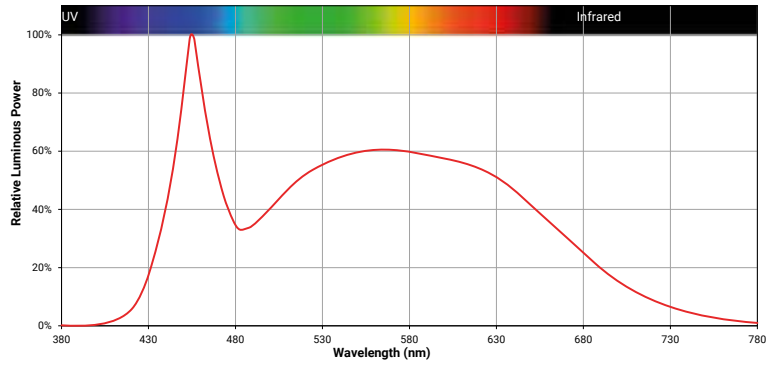

MEAT - ↓BBL (BELOW BBL)



The art of lighting meats and cured meats is closely linked to the careful use of colours. Enhancing the different shades of red in meat peaces contributes in giving a fresh and genuine appearance to the products. The white colour of bone and fat is not altered by light.

To display meats and sausages

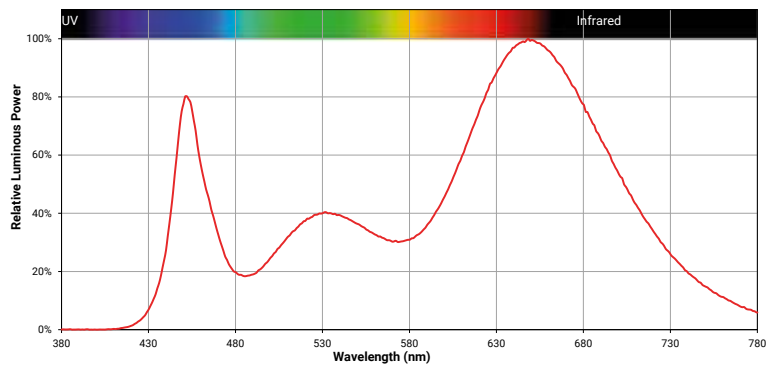

FRESH - 3000K



Clear and bright light gives to fruits and vegetables a fresh and inviting look, like a colourful market on sunny days. Customers can not miss to notice the quality of the products.

To enhance the freshness of fruit and vegetables

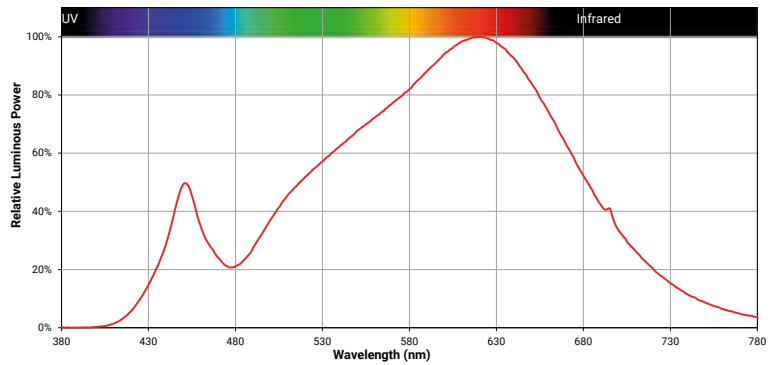

BAKERY - 2700K



The bread looks appetizing and crispy when the light absorbs its warm tone multiplying the effect. This increase of colour is also declined to cheese, which will be well presented according to their natural colours.

Light for cheese and bakery

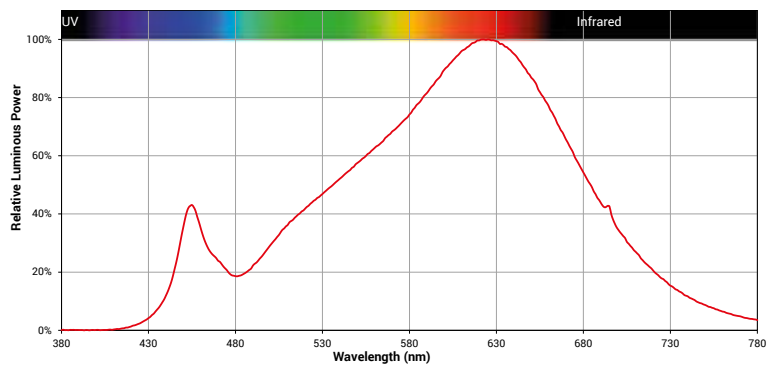





**SERVIRSI DA SOLI
È FACILE**
*Metti il guanto
che garantisce l'igiene*
*Usa il sacchetto per
ogni prodotto*
*Posalo sulla bilancia e premi
il numero corrispondente*



CET
**POMODORO
DATTERINO**

TERRECCHIO UNIVERSALE 20L
TERRECCHIO UNIVERSALE 20L
TERRECCHIO UNIVERSALE 20L
TERRECCHIO UNIVERSALE 20L

LINEAR PATHS OF LIGHT

trail linear LED trunking system



Trail is an innovative system of continuous LED lines offering the optimal lighting solution for particularly spacious areas in a sales environment. Its flexible design includes a wide variety of optics and three different powers. Trail features extraordinary efficiency, high brightness and is simple and fast to configure. Thanks to the topLED technology, Trail ensures significant energy savings with very low maintenance, thus speeding up initial investment payback time.

Materials

Steel (cap)

Extruded aluminum (lamp body)



VERSATILE, EFFICIENT AND EASY TO INSTALL

**HIGH EFFICIENCY**

Trail's great energy efficiency (up to 176 lm / w) and limited maintenance allow greater savings compared with the operating costs of traditional fluorescent systems.

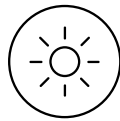
**QUALITY LIGHT**

Trail a1:f109 uniform and contrast-free illumination, lasting lighting with quality guaranteed by the scrupulous selection of perfectly compatible components.

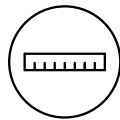
**FUNCTIONAL VERSATILITY**

Trail's characteristic modularity allows tailor-made configurations by selecting the most suitable lighting solution for each particular environment.

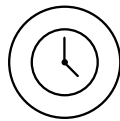
**EASY INSTALLATION**

Installing a trail continuous line is quick and easy: once the supporting structure is in place, the quick-fit system allows placement of individual lighting units to get the most suitable lighting for the space layout.

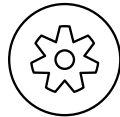
**REDUCED MAINTENANCE**

High quality components also ensure the system's longevity, drastically reducing maintenance.

**NEW CARTER AND QUICK RELEASE**

A new locking and release system thanks to new pressure springs. The model is also updated in the choice of material, pre-galvanized steel instead of aluminium.

**NO TOOLS AND REDUCED INSTALLATION TIMES**

No tools are required to install and connect trail, the technician can now work in total freedom. Assembly time is reduced by 45% compared to the previous version.

**NEW TRACK VERSION**

A new model was included in the range thanks to small changes in the wiring and earth leakage protection that allows adding a new track.

**UPS VERSION (UNINTERRUPTIBLE POWER SUPPLIES)**

Available on request for trail is the emergency light management system thanks to the ups wiring.

SPECS

WIDE RANGE OF OPTICS FOR EVERY NEED

ASYMMETRIC AND BI-ASYMMETRIC OPTICS

Side aisles (asymmetric) and centre aisles (biassymmetric) with shelves 2,20 m high. Installation height 3,5 m.

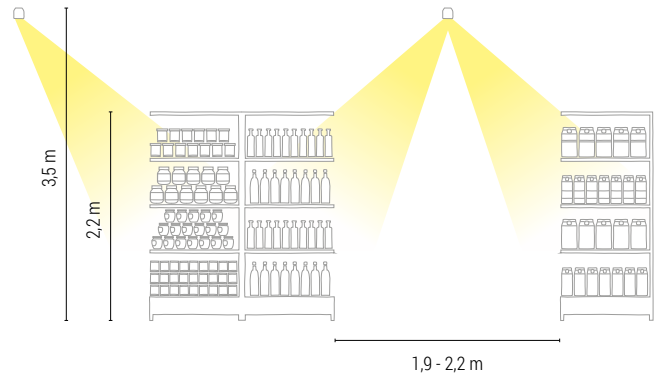

Bi-asymmetric optics, specifically designed for the central aisles of supermarkets, performs the dual function of general, comfortable lighting and guiding customers in the purchasing process.

The special lens directs the light sideways to focus attention on the shelves while reducing glare in transit areas. Customers' eyes are focussed on the displayed goods, making the purchase experience easier.

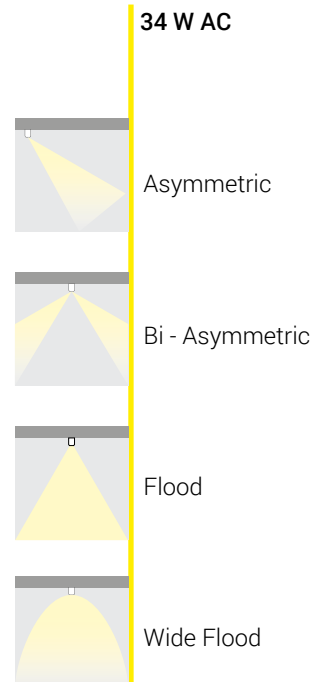

DIFFUSED OPTICS

Checkouts, gondolas and shelves max 1,50 m high.
Installation height 3,5 m.

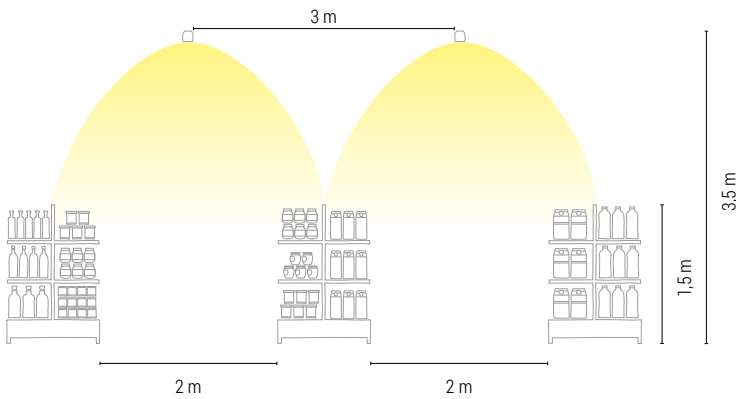

The diffused lens is suitable for the uniform lighting of shelves and aisles.

In chain stores Trail provides uniform illumination for entrances, checkouts and areas occupied by gondolas and low shelving. It can also be used to illuminate spaces without shelves and production departments.

System design is not bound by store layout, allowing settings to be restyled without having to reset any directional pointing.

60° OPTICS

Small warehouses and storerooms with shelves up to 6 m high. Installation height 8 m.

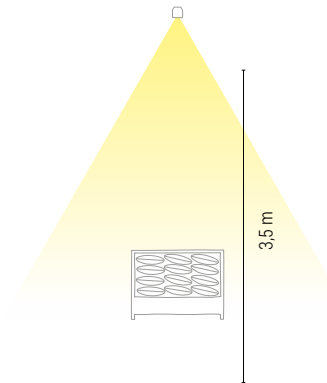

Trail_line with 60° medium-flood optics can replace the diffused version to fulfil the general lighting function in environments with ceiling heights up to 8 m.

In traditional chain store contexts it can be used for the direct lighting of gondolas, low display units and refrigerated sections, focussing customer attention on free-standing elements.

60° optics is also used in small warehouses and goods storage areas, where it ensures optimised, uniform lighting on aisles and racks.

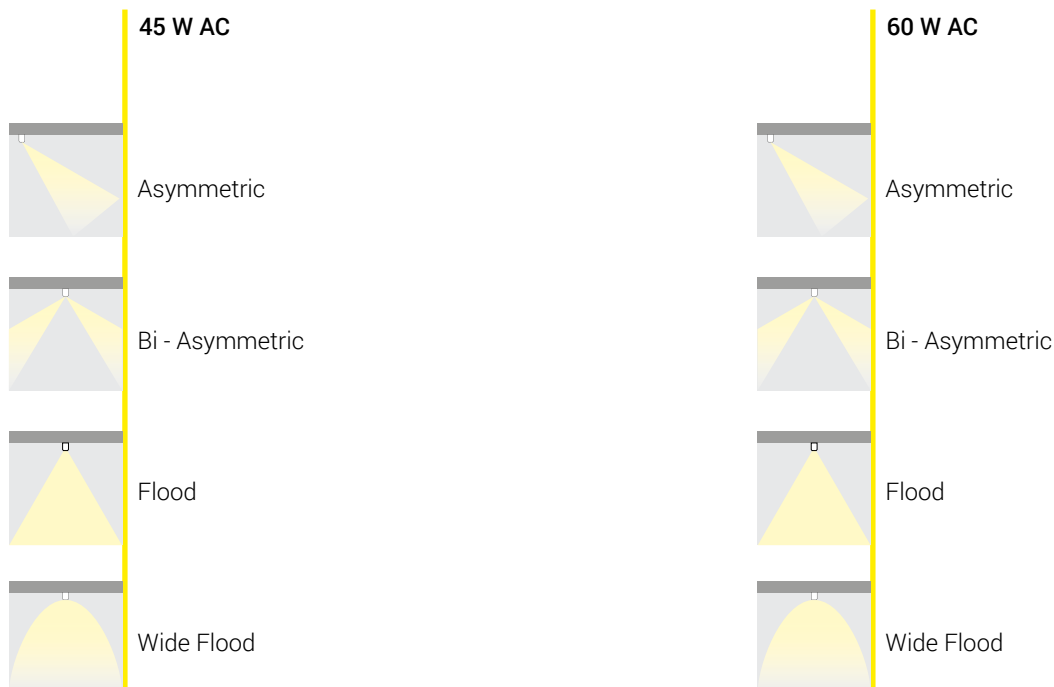

TRAIL TRACK SYSTEM ASSEMBLY SCHEME

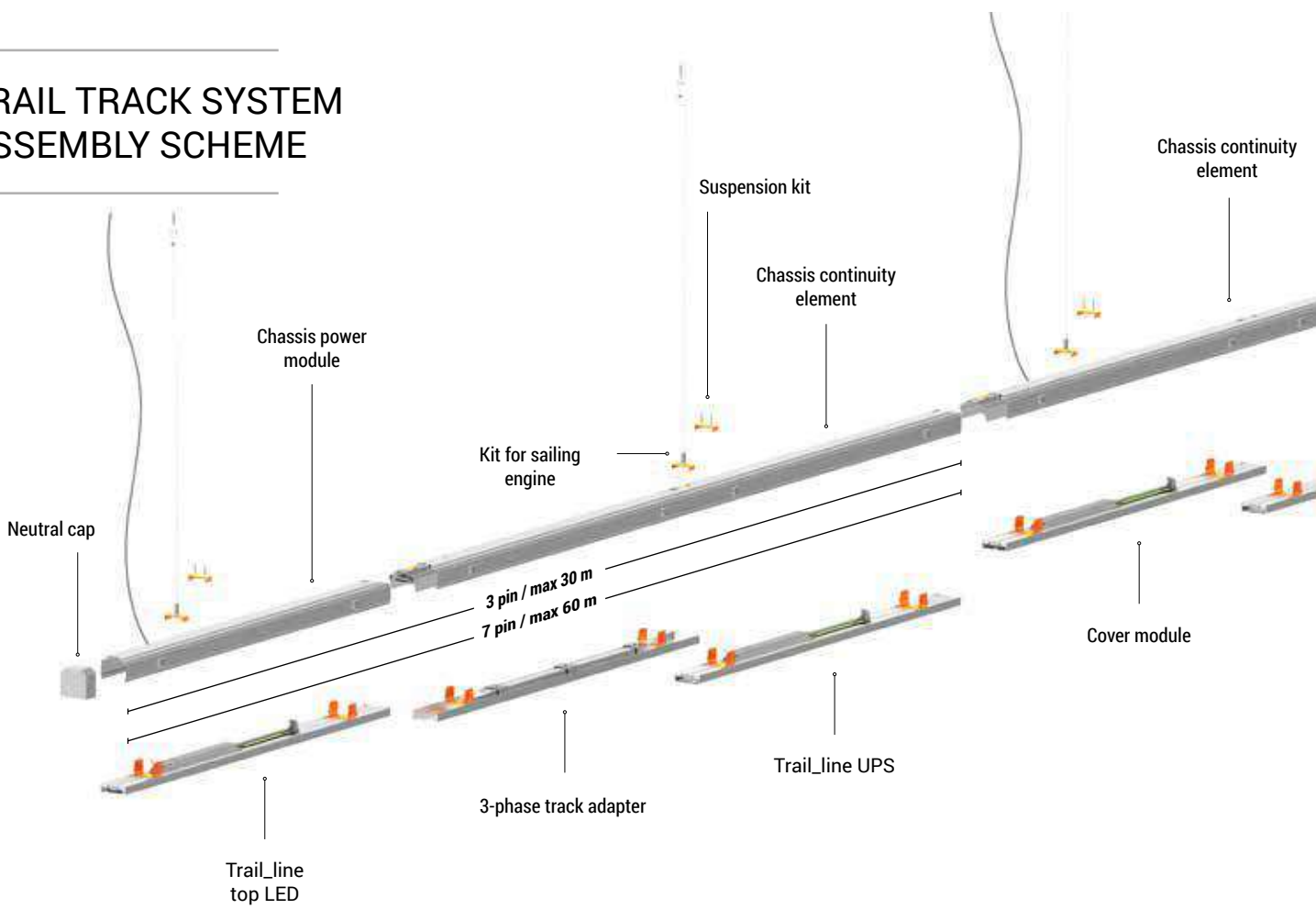

Trunking system | Trail_chassis | Power module

IP20

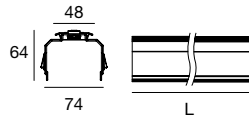

White	1135 mm	3 pin	ON/OFF	90911
Grey	1135 mm	3 pin	ON/OFF	90912
White	2270 mm	3 pin	ON/OFF	90915
Grey	2270 mm	3 pin	ON/OFF	90916
White	1135 mm	7 pin	ON/OFF / DALI	90913
Grey	1135 mm	7 pin	ON/OFF / DALI	90914
White	2270 mm	7 pin	ON/OFF / DALI	90917
Grey	2270 mm	7 pin	ON/OFF / DALI	90918

Trunking system | Trail_chassis | Continuity element

IP20

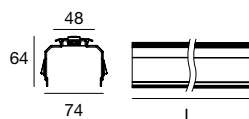

White	1135 mm	3 pin	ON/OFF	90903
Grey	1135 mm	3 pin	ON/OFF	90904
White	2270 mm	3 pin	ON/OFF	90907
Grey	2270 mm	3 pin	ON/OFF	90908
White	1135 mm	7 pin	ON/OFF / DALI	90905
Grey	1135 mm	7 pin	ON/OFF / DALI	90906
White	2270 mm	7 pin	ON/OFF / DALI	90909
Grey	2270 mm	7 pin	ON/OFF / DALI	90910

Trunking system | Trail chassis | Auxiliary power

IP20

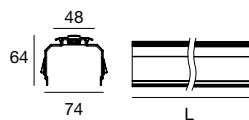

White	1135 mm	7 pin	ON/OFF / DALI	90905E
Grey	1135 mm	7 pin	ON/OFF / DALI	90906E

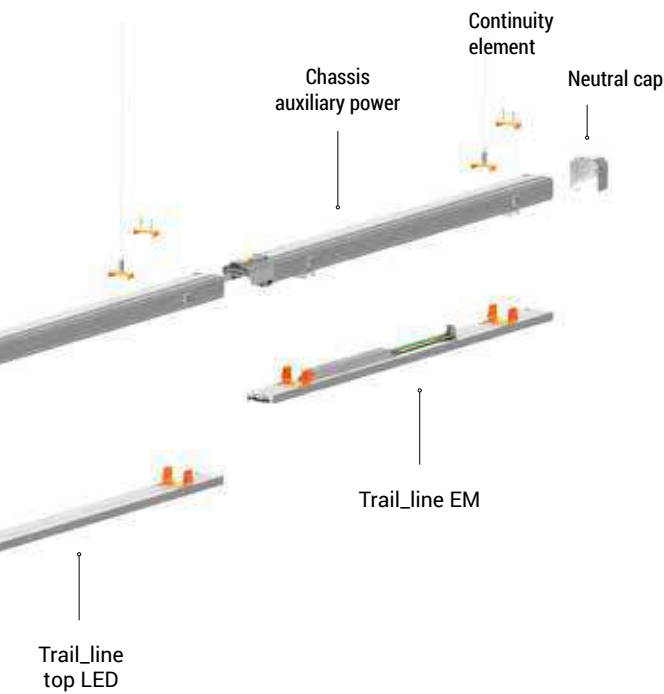

Ceiling installation

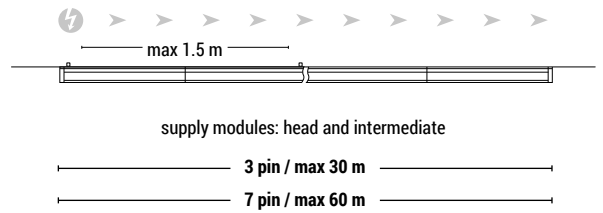

Suspended installation

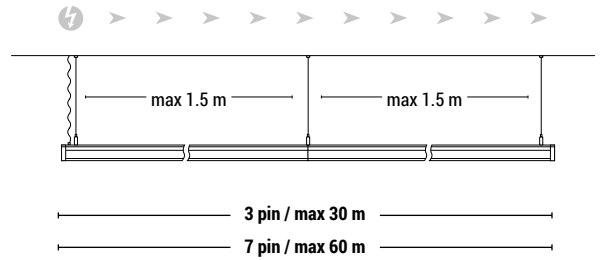

Trail_line | 190-250 V | 29 W topLED | 34 W AC device



Efficiency - CRI 83

White	3 pin	ON/OFF	90919	4000 K	5450 lm	N	Diffused	00
Grey	3 pin	ON/OFF	90920				60°	60
White	7 pin	ON/OFF	90921	4000 K	5450 lm	N	Asymmetric	07
Grey	7 pin	ON/OFF	90922				Double-asym.	69
White	7 pin	DALI	90923					
Grey	7 pin	DALI	90924					



Trail_line | 190-250 V | 41 W topLED | 45 W AC device

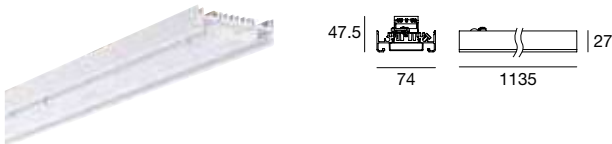

Efficiency - CRI 83

White	3 pin	ON/OFF	90925	4000 K	7000 lm	N	Diffused	00
Grey	3 pin	ON/OFF	90926				60°	60
White	7 pin	ON/OFF	90927	4000 K	7000 lm	N	Asymmetric	07
Grey	7 pin	ON/OFF	90928				Double-asym.	69
White	7 pin	DALI	90929					
Grey	7 pin	DALI	90930					



Trail_line | 190-250 V | 54 W topLED | 60 W AC device

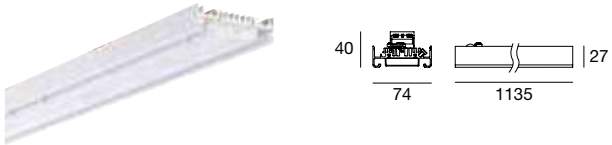

Efficiency - CRI 83

White	3 pin	ON/OFF	90931	4000 K	8700 lm	N	Diffused	00
Grey	3 pin	ON/OFF	90932				60°	60
White	7 pin	ON/OFF	90933	4000 K	8700 lm	N	Asymmetric	07
Grey	7 pin	ON/OFF	90934				Double-asym.	69
White	7 pin	DALI	90935					
Grey	7 pin	DALI	90936					



Trunking system | Trail_line | EM

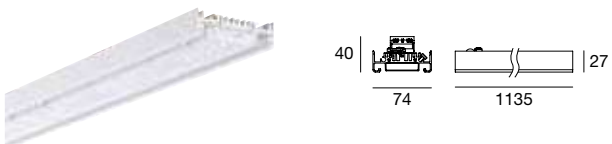

Stand alone auxiliary power on request

UPS SA or SE power on request



Trunking system | 3-phase track adapter

Module for track lights.
Maximum load 3kg.
Max power 60 W.

White	90952
Grey	90953

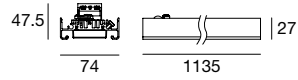

Trunking system | Suspension kit

Steel cable adjustable at the base,
necessary for suspended mounting and
available in two versions, 1.5 m and 3 m.

1500 mm	90944
3000 mm	90943

Prepare at least two cables for each
Trail_chassis module installed.

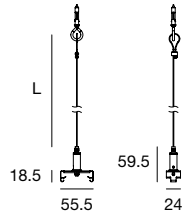

Trunking system | Kits for ceiling hanging

Steel bracket required
for ceiling mounting.
Prepare at least one bracket every 1,5 m of
Trail_chassis module installed.

	90945
--	--------------

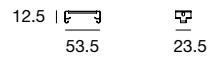

Trunking system | Neutral cap

Neutral closing end cap.

White	90946
Grey	90947

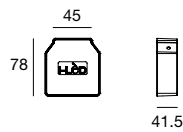

Trunking system | Cover module

Blank cover module.

White	90950
Grey	90951

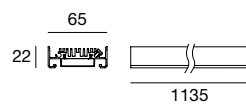



bulbo collection



Bulbo Collection lighting fixtures emit a coloured light resulting from the combination of light frequencies. These are selected to activate the photosynthesis process and stimulate growth in plants, including in poorly lit or light-free environments.

The special light spectrum, studied at the laboratories of the *Department of Agricultural Sciences at the University of Bologna - Alma Mater Studiorum*, reproduces the amount of sunlight that plants naturally absorb. For an optimal result, each lamp will be switched on and off regularly in order to reproduce the natural day/night cycle.
Recommended: 15 hours ON and 9 hours OFF.

design Lorenzo Antonioni, 2016-2018

Technology available to nature for plants' growth in places without sunlight.
Versatile and carefully designed. Bulbo fixtures will give you the pleasure of seeing your plants grow healthier day after day.

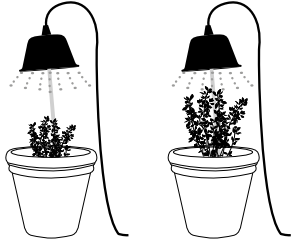

Planted in the soil

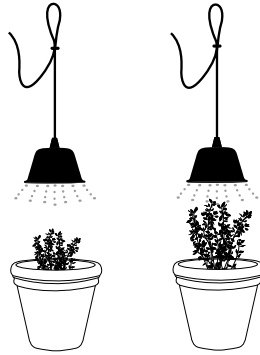

Suspended overhead by its cord from an existing support

CHLOROPHYLL_

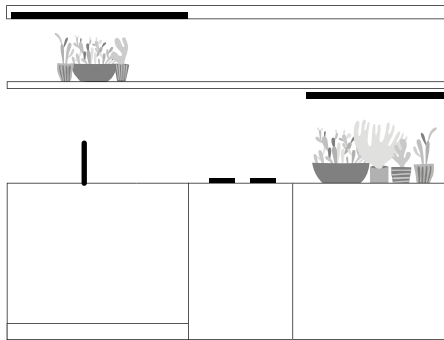

Under shelves or wall units
 Retail/contract/residential applications

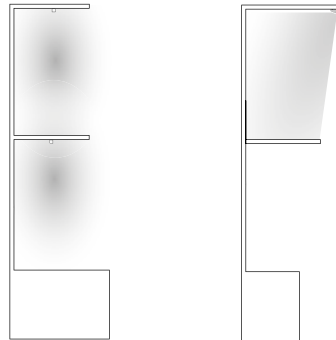

Thin
 Diffused emission

Reika
 Asymmetric emission

THIN-REIKA_

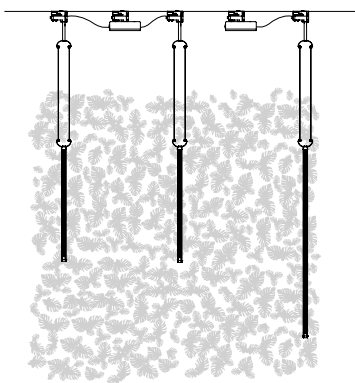

For green wall

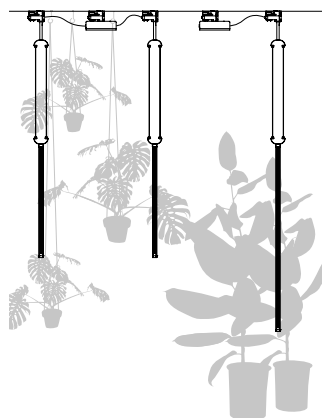

For suspended or large plants

VERTICAL_

Chlorophyll - Bulbo collection | Pot light | 220-240 V | 3 x powerLED 7 W

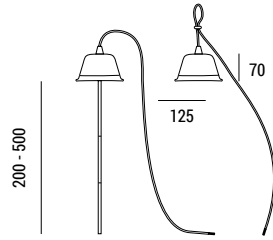

Terracotta **8010**

Pink **8011**

L. Azure **8012**

RWB 120°

Vertical_P1 - Bulbo collection | Track luminaires | 220-240 V | powerLED 24 W

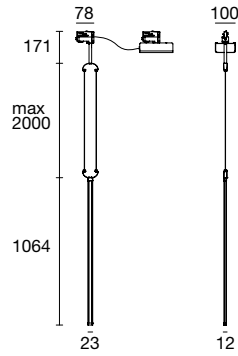

Anod. Al. **8584**

Anod. Bl. **8585**

RWB diffused

Anod. Al. **8586** x2 Vertical_P1 + driver 48 W

Anod. Bl. **8587** x2 Vertical_P1 + driver 48 W

RWB diffused

Vertical_P2 - Bulbo collection | Track luminaires | 220-240 V | powerLED 48 W

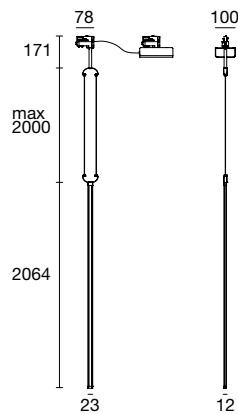
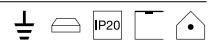

Anod. Al. **8588**

Anod. Bl. **8589**

RWB diffused



Thin - Bulbo collection | Linear profiles | 220-240 V | powerLED 12 W

III C.V. ~~IP20~~

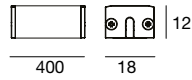

Anod. AL. **8562**
Anod. AL. **8563**

RWB 120°

Timer
15 h. ON 9 h. OFF

ELECTRONICS

KIT0067	KIT0068	KIT0070	KIT0071	KIT0072
ON/OFF Driver 1 pc	ON/OFF Driver 1-2 pc	ON/OFF Driver 1-4 pc	ON/OFF Driver 1-10 pc	ON/OFF Driver 9-15 pc

Thin - Bulbo collection | Linear profiles | 220-240 V | powerLED 18 W

III C.V. ~~IP20~~

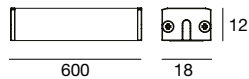

Anod. AL. **8566**
Anod. AL. **8567**

RWB 120°

Timer
15 h. ON 9 h. OFF

ELECTRONICS

KIT0068	KIT0070	KIT0071	KIT0072
ON/OFF Driver 1 pc	ON/OFF Driver 1-2 pc	ON/OFF Driver 1-6 pc	ON/OFF Driver 5-10 pc

Thin - Bulbo collection | Linear profiles | 220-240 V | powerLED 35 W

III C.V. ~~IP20~~

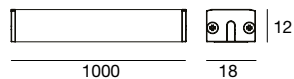

Anod. AL. **8570**
Anod. AL. **8571**

RWB 120°

Timer
15 h. ON 9 h. OFF

ELECTRONICS

KIT0069	KIT0071	KIT0072
ON/OFF Driver 1 pc	ON/OFF Driver 1-3 pc	ON/OFF Driver 3-5 pc

Reika - Bulbo collection | Linear profiles | 220-240 V | powerLED 12 W

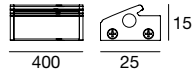

Anod. Al.	8574
Anod. Al.	8575

RWB Asymmetric

Timer
15 h. ON 9 h. OFF

ELECTRONICS

KIT0067	KIT0068	KIT0070	KIT0071	KIT0072
ON/OFF Driver 1 pc	ON/OFF Driver 1-2 pc	ON/OFF Driver 1-4 pc	ON/OFF Driver 1-10 pc	ON/OFF Driver 9-15 pc

Reika - Bulbo collection | Linear profiles | 220-240 V | powerLED 18 W

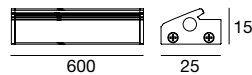

Anod. Al.	8578
Anod. Al.	8579

RWB Asymmetric

Timer
15 h. ON 9 h. OFF

ELECTRONICS

KIT0068	KIT0070	KIT0071	KIT0072
ON/OFF Driver 1 pc	ON/OFF Driver 1-2 pc	ON/OFF Driver 1-6 pc	ON/OFF Driver 15-10 pc

Reika - Bulbo collection | Linear profiles | 220-240 V | topLED 35 W

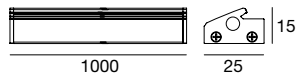

Anod. Al.	8582
Anod. Al.	8583

RWB Asymmetric

Timer
15 h. ON 9 h. OFF

ELECTRONICS

KIT0069	KIT0071	KIT0072
ON/OFF Driver 1 pc	ON/OFF Driver 1-3 pc	ON/OFF Driver 3-5 pc

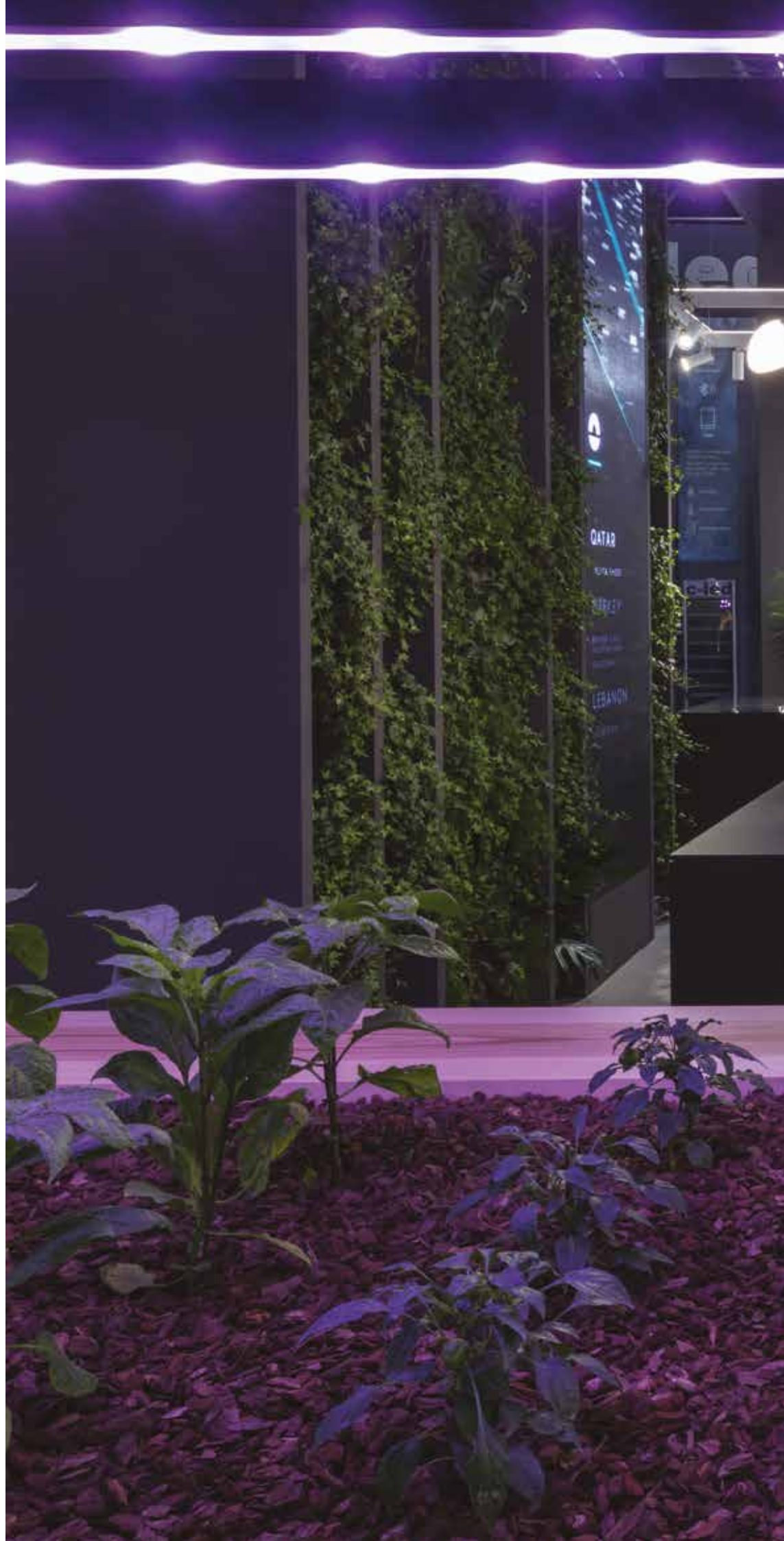



DOWNLIGHTS LIGHT ACCENTS

downlights optus_ex



Optus is a new range of products designed for the retail sector: their clean shapes and small sizes can be combined with track and channel Creek spotlights, pull-out ceiling recessed luminaires, window lighting.

Optus_EX is a recessed and pull-out ceiling lighting fixture featuring a 350° rotation on the horizontal axis and a 65° tilt (from -20° to + 45°) on the vertical axis.

Available in two sizes, Optus_EX can be combined with Balance - CRI 92, Specialty - CRI 98 e Fidelity - CRI 98 LEDs; the available optics are Spot (15°), Medium Flood (30°) and Flood (60°). They are interchangeable and integrated with beam and glare control Accessories.

Materials

Die-cast aluminium

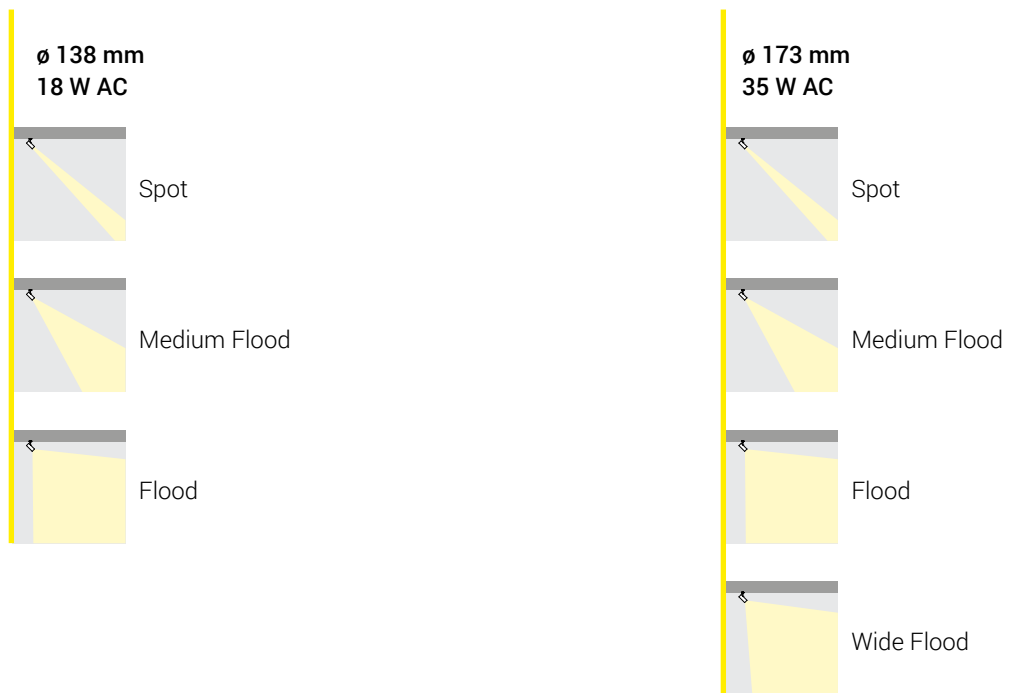

LIGHTING FIXTURES CAN BE COMBINED WITH

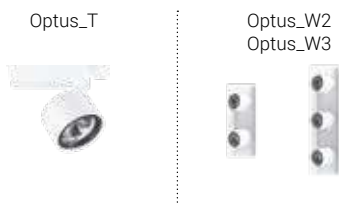

SPOTLIGHTS AVAILABLE WITH EYE-WIFI TECHNOLOGY



TRACK SPOTLIGHTS SPECIFIC FOR FOOD



Projectors available with specific LEDs for lighting meat, fish and bakery / dairy products. Go to page 110

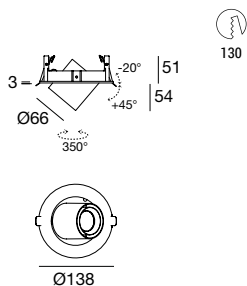

Specialty - CRI 98

White	80342	3000 K	1635 lm	W	Spot	15
Black	80343				Medium Flood	30
					Flood	60

Fidelity - CRI 98

White	80344	3000 K	1753 lm	W	Spot	15
Black	80345	4000 K	1885 lm	N	Medium Flood	30
					Flood	60

Balance - CRI 92

White	80220	3000 K	2016 lm	W	Spot	15
Black	80221	4000 K	2170 lm	N	Medium Flood	30
					Flood	60

TIR LENSES



98995

Spot



98996

Medium Flood



98997

Flood

ELECTRONICS



99106

ON/OFF
1 art.



99115

1-10V
1 art.



99114

DALI
1 art.



99355

EMERGENCY
1 art. 226

ACCESSORIES



99510

Kicker



99531

Cross louvre



99530

Elliptical filter



99532

Honeycomb



99533

Anti-glare pipe



99534

Anti-glare pipe a 45°

Optus_EX2 | Downlight | 35 W 950 mA arrayLED

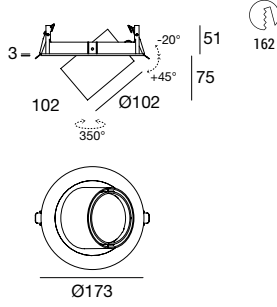

Specialty - CRI 98

White	80238	3000 K	3297 lm	W	Spot	15
Black	80239				Medium Flood	30
					Flood	60
					Wide	90

Fidelity - CRI 98

White	80241	3000 K	3526 lm	W	Spot	15
Black	80242	4000 K	3792 lm	N	Medium Flood	30
					Flood	60
					Wide	90

Balance - CRI 92

White	80232	3000 K	4058 lm	W	Spot	15
Black	80233	4000 K	4363 lm	N	Medium Flood	30
					Flood	60
					Wide	90

OPTICS

99471	99404	99405	99406
Spot	Medium Fl.	Flood	Wide Flood

ELECTRONICS

99239	99241	99345	99355
ON/OFF 1 art.	1-10V DALI 1 art.	DALI 1 art.	EMERGENCY 1 art. ▢ 226

ACCESSORIES

99479	98520	99654	99655	98519	98518	98523
Kicker	Cross louvre	Elliptical filter	Honeycomb	Anti-glare pipe	Anti-glare pipe a 45°	Directional flaps





Audi A1

downlights illuminator



Illuminator is a series of modular luminaires for false ceilings mounting, available in two models with one, two or three adjustable modules.

The smaller version is compatible with luminaires with Balance - CRI 92 LEDs and Spot (15°), Medium Flood (30°) and Flood (60°) optics that can be integrated with beam and glare control accessories.

The larger version is compatible with luminaires with Balance - CRI 92 LEDs, and interchangeable Spot (15°), Medium Flood (30°) and Flood (60°) optics.

Materials

Iron sheet
die-cast aluminium

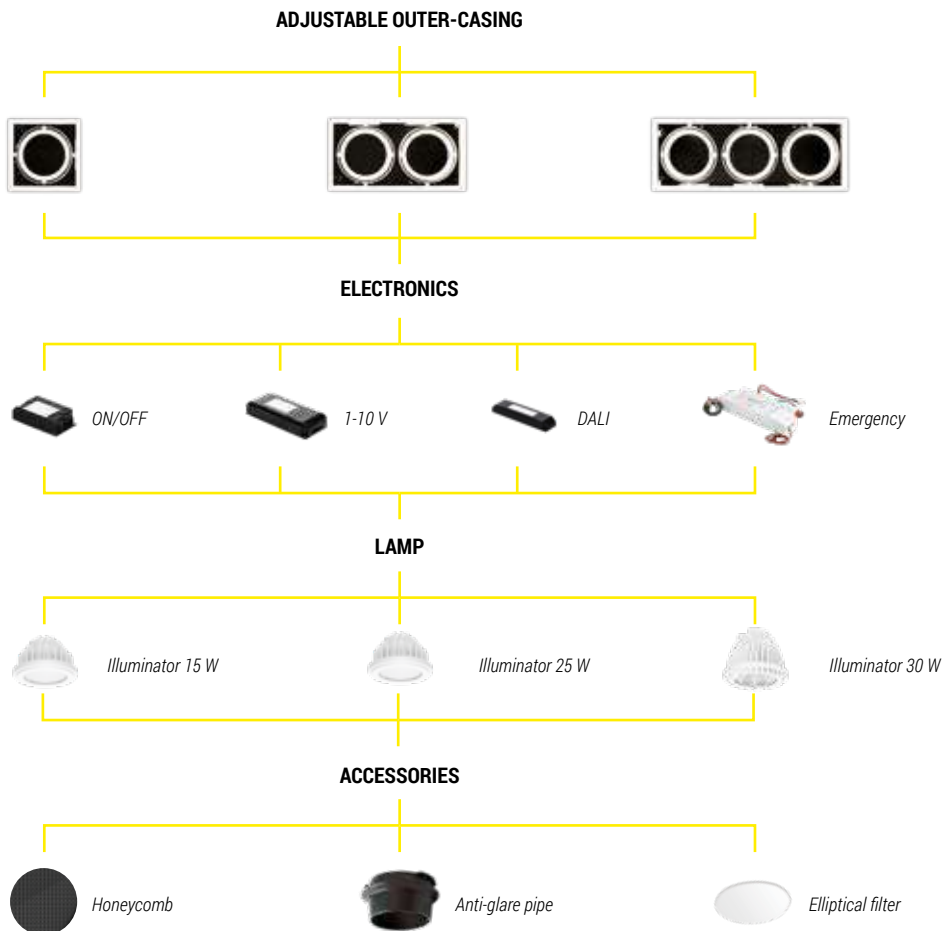
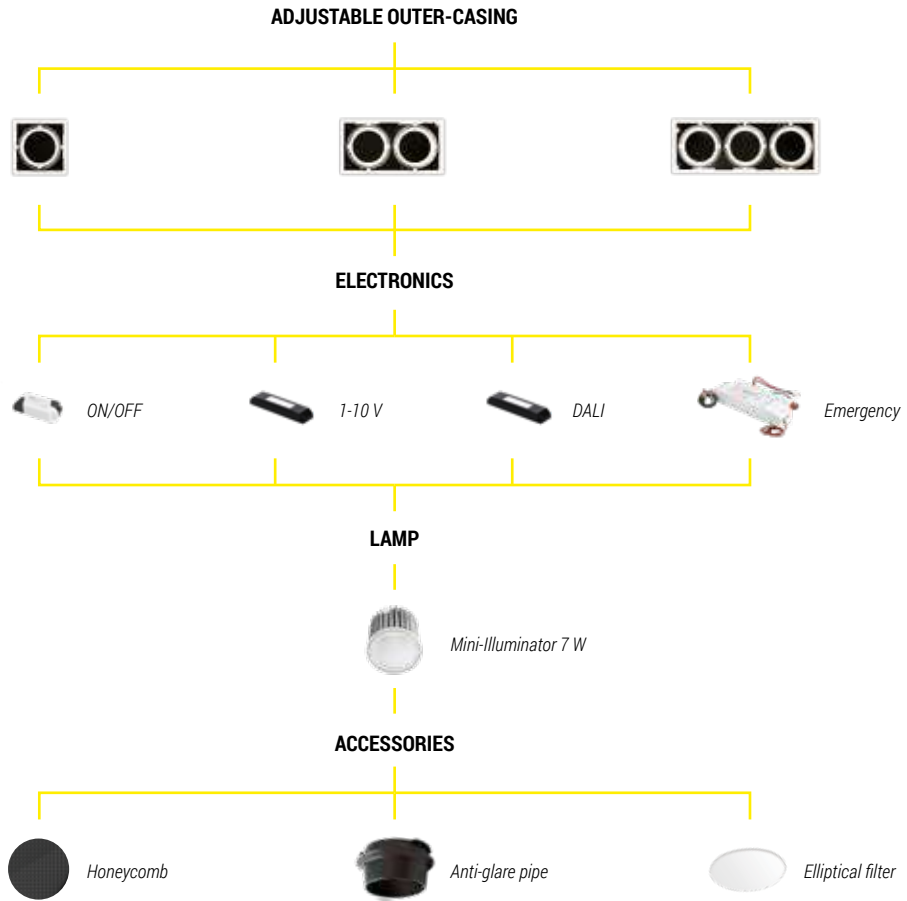

Mini-Illuminator | Adjustable outer-casing 1x

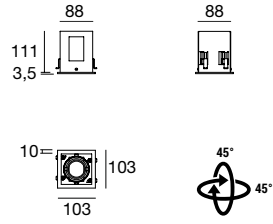

White	1 x lamp	99485
Black	1 x lamp	99488

Mini-Illuminator | Adjustable outer-casing 2x

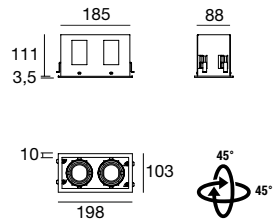

White	2 x lamp	99486
Black	2 x lamp	99489

Mini-Illuminator | Adjustable outer-casing 3x

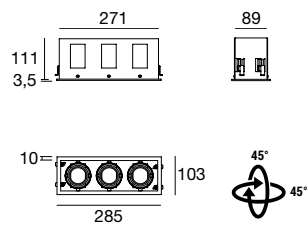

White	3 x lamp	99487
Black	3 x lamp	99490

Mini-illuminator | Accessories



Honeycomb

Black **99550**



Anti-glare pipe

Black **99554**



Elliptical filter

Black **99552**

Mini-illuminator | Lamp | 7 W AC arrayLED



Anod. Al.	80338	3000 K	665 lm	W	Spot	15
		4000 K	718 lm	N	M. Flood	30
					Flood	60

* the dimmable versions of the product (1-10V and DALI) supply a maximum of 6.2W when powered 100%.

ELECTRONICS



99243
ON/OFF
1 art.
700mA



99262*
1-10V
1-3 art.
630mA



99114*
DALI
1-3 art.
630mA



99355
EMERGENCY
1 art. ▶ 226

Illuminator | Adjustable outer-casing 1x

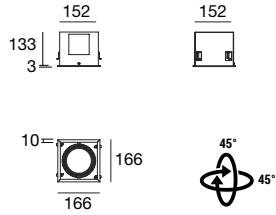

White	1 x lamp	99497
Black	1 x lamp	99500

Illuminator | Adjustable outer-casing 2x

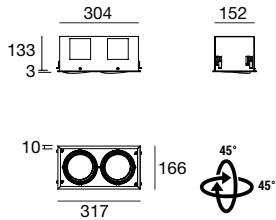

White	2 x lamp	99498
Black	2 x lamp	99501

Illuminator | Adjustable outer-casing 3x

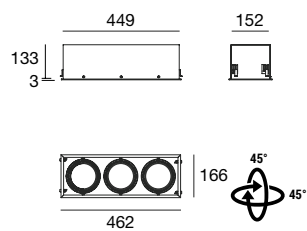

White	3 x lamp	99499
Black	3 x lamp	99502

Illuminator | Accessories



Honeycomb

Black **99551**



Anti-glare pipe

Black **99555**



Elliptical filter

Black **99553**

Illuminator_1 | Lamp | 15 W 400 mA arrayLED

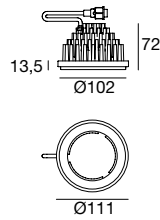

Balance - CRI 92

White	80389	3000 K	1677 lm	W	M. Flood	30
Black	80390	4000 K	1804 lm	N	Flood	60

OPTICS



99561 **99562**
Medium Flood Flood

ELECTRONICS



99113 **99116** **99131** **99355**
ON/OFF 1-10V DALI EMERGENCY
1 art. 1 art. 1 art. 1 art. ▶ 226

Illuminator_1 | Lamp | 25 W 720 mA arrayLED

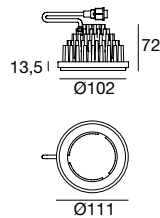

Balance - CRI 92

White	80387	3000 K	2794 lm	W	M. Flood	30
Black	80388	4000 K	2990 lm	N	Flood	60

OPTICS



99561 **99562**
Medium Flood Flood

ELECTRONICS



99112 **99188** **99330** **99355**
ON/OFF 1-10V DALI EMERGENCY
1 art. 1 art. 1 art. 1 art. ▶ 226

Illuminator_3 | Lamp | 30 W 840 mA arrayLED

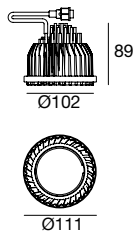

Balance - CRI 92

White	91229	3000 K	3554 lm	W	Spot	15
Black	91230	4000 K	3806 lm	N	M. Flood	30
					Flood	60

OPTICS



98507 **98508** **98509**
Spot Medium Flood Flood

ELECTRONICS



99093 **99187** **99330** **99355**
ON/OFF 1-10V DALI EMERGENCY
1 art. 1 art. 1 art. 1 art. ▶ 226





downlights blob40



Specially designed for retro-fitting, Blob40 is a **high-performance downlight for general lighting**.

Available in two sizes, Blob40 can be combined with Efficiency and Balance LEDs. The sandblasted polycarbonate diffuser ensures a high **visual comfort**.

Materials

Die-cast aluminium



Ø 100 mm
18 W 500 mA

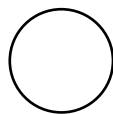

Ø 140 mm
26 W 720 mA

Blob40_1 | Downlight | 18 W 500 mA arrayLED

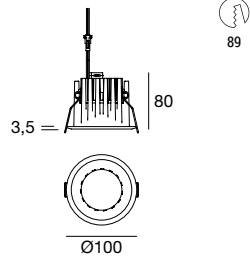

Balance - CRI 92

White	80105	2700 K	1885 lm	M	General	00
Black	80106	3000 K	2016 lm	W		
		4000 K	2170 lm	N		

Efficiency

White	80107	2700 K	2323 lm	M	General	00
Black	80108	3000 K	2323 lm	W		
		4000 K	2498 lm	N		

ELECTRONICS



99106
ON/OFF
1 art.



99115
1-10V
1 art.



99114
DALI
1 art.



99355
EMERGENCY
1 art.
▶ 226

Blob40_2 | Downlight | 26 W 720 mA arrayLED

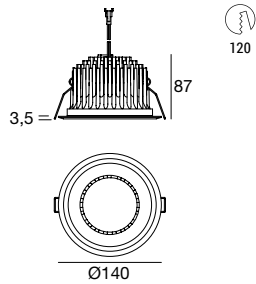

Balance - CRI 92

White	80015	2700 K	2598 lm	M	General	00
Black	80016	3000 K	2794 lm	W		
		4000 K	2990 lm	N		

Efficiency

White	80013	2700 K	3210 lm	M	General	00
Black	80014	3000 K	3431 lm	W		
		4000 K	3431 lm	N		

ELECTRONICS



99147
ON/OFF
1 art.



99268
1-10V
1 art.



99345
DALI
1 art.



99355
EMERGENCY
1 art.
▶ 226



downlights cob40



SCALE 1:1

Cob40 is a **small-sized, highly efficient** recessed luminaire.

Cob40 is available in the fixed or tilting version, with Spot (15°), Medium Flood (30°) and Flood (60°) optics and LED Efficiency optics.

Materials

Die-cast aluminum
Polycarbonate (optic)

Cob40_R | Downlight | 7 W 700 mA arrayLED

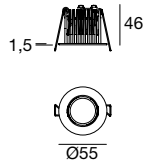

48

Efficiency

White	80244	2700 K	770 lm	M	Spot	15
Black	80245	3000 K	770 lm	W	M. Flood	30
		4000 K	831 lm	N	Flood	60

ELECTRONICS



99243
ON/OFF
1 art.
700mA



99262*
1-10V
1-3 art.
630mA



99114*
DALI
1-3 art.
630mA



99355
EMERGENCY
1 art.
▶ 226

Cob40_RJ | Downlight | 7 W 700 mA arrayLED

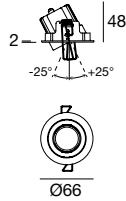

60

Efficiency

White	80109	2700 K	770 lm	M	Spot	15
Black	80110	3000 K	770 lm	W	M. Flood	30
		4000 K	831 lm	N	Flood	60

ELECTRONICS



99243
ON/OFF
1 art.
700mA



99262*
1-10V
1-3 art.
630mA



99114*
DALI
1-3 art.
630mA



99355
EMERGENCY
1 art.
▶ 226

* the dimmable versions of the product (1-10V and DALI) supply a maximum of 6.2W when powered 100%.

downlights cob44



SCALE 1:1
H 100 mm

A complete line of recessed downlights featuring an **IP44 protection index**. Cob44 can come with round or square flange, fixed or tilting Optics unit and two power levels. Cob44 is available with Spot (15°), Medium Flood (30°) and Flood (60°) optics and LED Efficiency.

Materials

Polycarbonate
Die-cast aluminium



STANDARD OPTICS

TILTING OPTICS

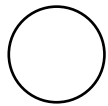

Ø 68 mm
7 W

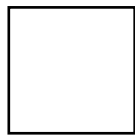

74 mm
7 W

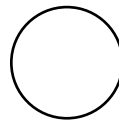

Ø 70 mm
7 W

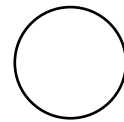

Ø 70 mm
11 W

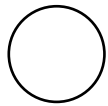

Ø 68 mm
11 W

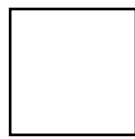

74 mm
11 W

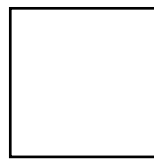

90 mm
7 W

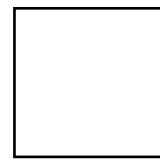

90 mm
11 W



Cob44_R | Downlight | 7 W 700 mA arrayLED

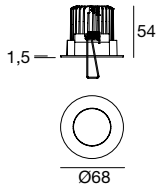

Efficiency

White	96801	2700 K	770 lm	M	Spot	15
Black	96802	3000 K	770 lm	W	M. Flood	30
		4000 K	831 lm	N	Flood	60

ELECTRONICS

99243	99262*	99114*	99355
ON/OFF 1 art. 700mA	1-10V 1-3 art. 630mA	DALI 1-3 art. 630mA	EMERGENCY 1 art. 226

Cob44_R | Downlight | 11 W 300 mA arrayLED

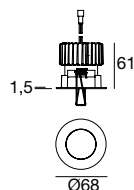

Efficiency

White	93832	2700 K	1399 lm	M	Spot	15
Black	93833	3000 K	1399 lm	W	M. Flood	30
		4000 K	1507 lm	N	Flood	60

ELECTRONICS

99370	99572	99573	99355
ON/OFF 1 art. 300mA	1-10V 1 art. 300mA	DALI 1 art. 300mA	EMERGENCY 1 art. 226

Cob44_RJ | Downlight | 7 W 700 mA arrayLED

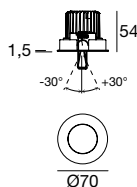
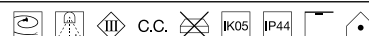

Efficiency

White	96803	2700 K	770 lm	M	Spot	15
Black	96804	3000 K	770 lm	W	M. Flood	30
		4000 K	831 lm	N	Flood	60

ELECTRONICS

99243	99262*	99114*	99355
ON/OFF 1 art. 700mA	1-10V 1-3 art. 630mA	DALI 1-3 art. 630mA	EMERGENCY 1 art. 226

Cob44_RJ | Downlight | 11 W 300 mA arrayLED

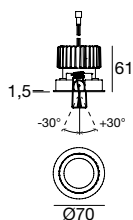

Efficiency

White	93834	2700 K	1399 lm	M	Spot	15
Black	93835	3000 K	1399 lm	W	M. Flood	30
		4000 K	1507 lm	N	Flood	60

ELECTRONICS

99370	99572	99573	99355
ON/OFF 1 art. 300mA	1-10V 1 art. 300mA	DALI 1 art. 300mA	EMERGENCY 1 art. 226

* the dimmable versions of the product (1-10V and DALI) supply a maximum of 6.2W when powered 100%.

Cob44_Q | Downlight | 7 W 700 mA arrayLED

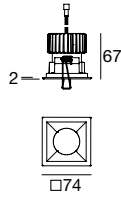

7 W 700 mA - CRI 80

White	93354
Black	93355

CCT

2700 K	770 lm	M
3000 K	770 lm	W
4000 K	831 lm	N

optic

Spot	15
M. Flood	30
Flood	60

ELECTRONICS

99243	99262*	99114*	99355
ON/OFF 1 art. 700mA	1-10V 1-3 art. 630mA	DALI 1-3 art. 630mA	EMERGENCY 1 art. 226

Cob44_Q | Downlight | 11 W 300 mA arrayLED

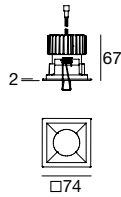

Efficiency

White	93836
Black	93839

2700 K	1399 lm	M
3000 K	1399 lm	W
4000 K	1507 lm	N

Spot	15
M. Flood	30
Flood	60

ELECTRONICS

99370	99572	99573	99355
ON/OFF 1 art. 300mA	1-10V 1 art. 300mA	DALI 1 art. 300mA	EMERGENCY 1 art. 226

Cob44_QJ | Downlight | 7 W 700 mA arrayLED

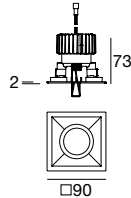

Efficiency

White	93844
Black	93847

2700 K	770 lm	M
3000 K	770 lm	W
4000 K	831 lm	N

Spot	15
M. Flood	30
Flood	60

ELECTRONICS

99243	99262*	99114*	99355
ON/OFF 1 art. 700mA	1-10V 1-3 art. 630mA	DALI 1-3 art. 630mA	EMERGENCY 1 art. 226

Cob44_QJ | Downlight | 11 W 300 mA arrayLED

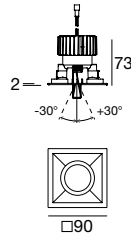

Efficiency

White	93840
Black	93843

2700 K	1399 lm	M
3000 K	1399 lm	W
4000 K	1507 lm	N

Spot	15
M. Flood	30
Flood	60

ELECTRONICS

99370	99572	99573	99355
ON/OFF 1 art. 300mA	1-10V 1 art. 300mA	DALI 1 art. 300mA	EMERGENCY 1 art. 226

* the dimmable versions of the product (1-10V and DALI) supply a maximum of 6.2W when powered 100%.



LE



downlights cob20



Recessed Cob20 is the result of careful research aimed at obtaining **outstanding performance** combined with **maximum ease of installation**.

The structure contains a reflective aluminium Optics compartment for **high-efficiency** emission, guaranteed by the Efficiency source. Cob20 is particularly suitable for the general lighting of public spaces: the proposed models can be powered with potential lower than required to ensure greater versatility of application.

Materials

Aluminum: heat sink and optics

Steel: brackets

ABS: flanges

LONG LIFE DURATION

Luminaires equipped with a high efficiency passive dissipation system with 6060 alloy extruded aluminum profiles. A compact beam radius exploits the maximum surface to efficiently cool down the LED source. Its characteristics are the material, the surface and the connection to the LED source.

The heat sink is built with extruded aluminum profiles joined in a compact diameter and arranged in such a way to have a wide cooling surface. Between the LEDs and the heat sink there is a special heat conducting film which guarantees optimal dissipation and consequently guarantees the long life of the item. **(70000 hours - L80).**

PASSIVE COOLING

50.3° C



23.3° C

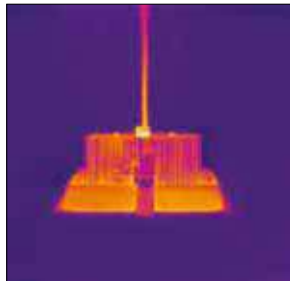

This frame taken by thermal detector, reports the temperature levels of the lamp after few minutes from ignition at room temperature of about 22° C.

MAX TEMP. DETECTED **42.1° C**
MIN TEMP. DETECTED **23.3° C**

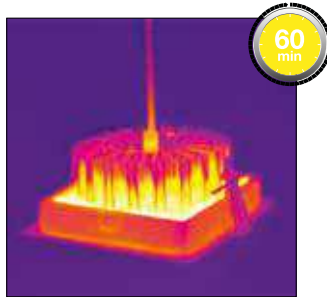

This frame was taken an hour after the lamp was turned on. Highly visible is how the generated heat by the LEDs is optimally dispersed by the heat sink placed in close contact with the part where the LED circuits are hosted.

MAX TEMP. DETECTED **50.3° C**
MIN TEMP. DETECTED **26.3° C**

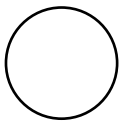

Ø 147 mm
15 W - 25 W

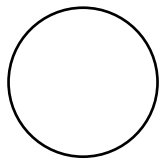

Ø 197 mm
15 W - 25 W - 30 W

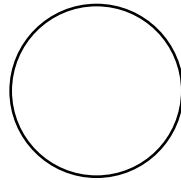

Ø 227 mm
15 W - 25 W - 30 W - 40 W

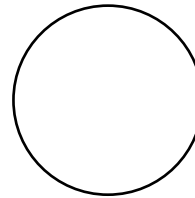

Ø 250 mm
15 W - 25 W - 30 W - 40 W

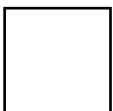

140 mm
15 W - 25 W

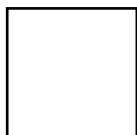

175 mm
15 W - 25 W - 30 W



205 mm
15 W - 25 W - 30 W - 40 W

COB20_R | Downlight | arrayLED | Ø 147 | 15 W - 25 W

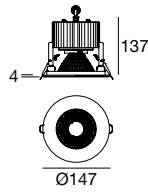

129

Efficiency

White	96809	2700 K	M	Flood	40
		3000 K	W	W. Flood	90
		4000 K	N		

Power	Current	Nominal flux		ON/OFF	1-10V	DALI
15 W	400 mA	2700 K	1 953 lm	99113 1 art.	99116 1 art.	99131 1 art.
		3000 K	2088 lm			
		4000 K	2088 lm			
25 W	720 mA	2700 K	3210 lm	99112 1 art.	99188 1 art.	99330 1 art.
		3000 K	3431 lm			
		4000 K	3431 lm			

ELECTRONICS



99355

EMERGENCY
1 art.
▶ 226

COB20_R | Downlight | arrayLED | Ø 197 | 15 W - 25 W - 30 W

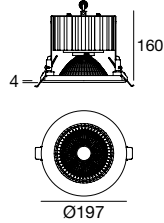

180

Efficiency

White	96813	2700 K	M	Flood	40
		3000 K	W	W. Flood	90
		4000 K	N		

Power	Current	Nominal flux		ON/OFF	1-10V	DALI
15 W	400 mA	2700 K	2082 lm	99113 1 art.	99116 1 art.	99131 1 art.
		3000 K	2227 lm			
		4000 K	2393 lm			
25 W	720 mA	2700 K	3400 lm	99112 1 art.	99188 1 art.	99330 1 art.
		3000 K	3637 lm			
		4000 K	3909 lm			
30 W	840 mA	2700 K	3991 lm	99093 1 art.	99187 1 art.	99330 1 art.
		3000 K	4270 lm			
		4000 K	4588 lm			



99355

EMERGENCY
1 art.
▶ 226

COB20_R | Downlight | arrayLED | Ø 227 | 15 W - 25 W - 30 W - 40 W

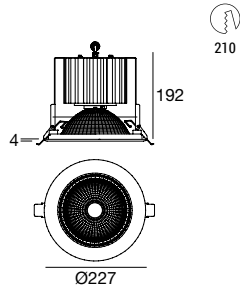

Efficiency

White	96819	2700 K	M	Flood	40
		3000 K	W	W. Flood	90
		4000 K	N		

Power	Current	Nominal flux		ON/OFF	1-10V	DALI
15 W	400 mA	2700 K	2082 lm	99113 1 art.	99116 1 art.	99131 1 art.
		3000 K	2227 lm			
		4000 K	2393 lm			
25 W	720 mA	2700 K	3400 lm	99112 1 art.	99188 1 art.	99330 1 art.
		3000 K	3637 lm			
		4000 K	3909 lm			
30 W	840 mA	2700 K	3991 lm	99093 1 art.	99187 1 art.	99330 1 art.
		3000 K	4270 lm			
		4000 K	4588 lm			
40 W	1100 mA	2700 K	4889 lm	99252 1 art.	99254 1 art.	99254 1 art.
		3000 K	5230 lm			
		4000 K	5620 lm			

ELECTRONICS



99355

EMERGENCY
1 art.
▶ 226

COB20_R | Downlight | arrayLED | Ø 250 | 15 W - 25 W - 30 W - 40 W

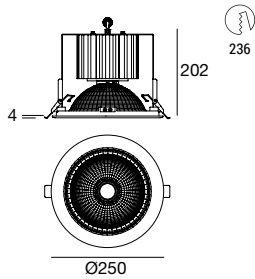

Efficiency

White	97130	2700 K	M	Flood	40
		3000 K	W	W. Flood	90
		4000 K	N		

Power	Current	Nominal flux		ON/OFF	1-10V	DALI
15 W	400 mA	2700 K	2082 lm	99113 1 art.	99116 1 art.	99131 1 art.
		3000 K	2227 lm			
		4000 K	2393 lm			
25 W	720 mA	2700 K	3400 lm	99112 1 art.	99188 1 art.	99330 1 art.
		3000 K	3637 lm			
		4000 K	3909 lm			
30 W	840 mA	2700 K	3991 lm	99093 1 art.	99187 1 art.	99330 1 art.
		3000 K	4270 lm			
		4000 K	4588 lm			
40 W	1100 mA	2700 K	4889 lm	99252 1 art.	99254 1 art.	99254 1 art.
		3000 K	5230 lm			
		4000 K	5620 lm			

ELECTRONICS



99355

EMERGENCY
1 art.
▶ 226

COB20_Q | Downlight | arrayLED | □140 | 15 W - 25 W

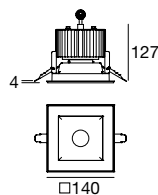

Efficiency

White	96827	2700 K	M	W. Flood	90
		3000 K	W		
		4000 K	N		

Power	Current	Nominal flux		ON/OFF	1-10V	DALI
15 W	400 mA	2700 K	1953 lm	99113 1 art.	99116 1 art.	99131 1 art.
		3000 K	2088 lm			
		4000 K	2088 lm			
25 W	720 mA	2700 K	3210 lm	99112 1 art.	99188 1 art.	99330 1 art.
		3000 K	3431 lm			
		4000 K	3431 lm			

ELECTRONICS



99355

EMERGENCY
1 art.
▶ 226

COB20_Q | Downlight | arrayLED | □175 | 15 W - 25 W - 30 W

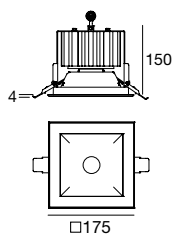

Efficiency

White	96831	2700 K	M	W. Flood	90
		3000 K	W		
		4000 K	N		

Power	Current	Nominal flux		ON/OFF	1-10V	DALI
15 W	400 mA	2700 K	2082 lm	99113 1 art.	99116 1 art.	99131 1 art.
		3000 K	2227 lm			
		4000 K	2393 lm			
25 W	720 mA	2700 K	3400 lm	99112 1 art.	99188 1 art.	99330 1 art.
		3000 K	3637 lm			
		4000 K	3909 lm			
30 W	840 mA	2700 K	3991 lm	99093 1 art.	99187 1 art.	99330 1 art.
		3000 K	4270 lm			
		4000 K	4588 lm			

ELECTRONICS



99355

EMERGENCY
1 art.
▶ 226

COB20_Q | Downlight | arrayLED | □205 | 15 W - 25 W - 30 W - 40 W

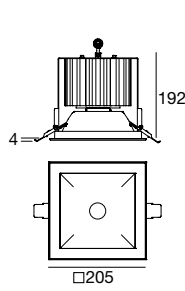

Efficiency

White	96837	2700 K	M	W. Flood	90
		3000 K	W		
		4000 K	N		

Power	Current	Nominal flux		ON/OFF	1-10V	DALI
15 W	400 mA	2700 K	2082 lm	99113 1 art.	99116 1 art.	99131 1 art.
		3000 K	2227 lm			
		4000 K	2393 lm			
25 W	720 mA	2700 K	3400 lm	99112 1 art.	99188 1 art.	99330 1 art.
		3000 K	3637 lm			
		4000 K	3909 lm			
30 W	840 mA	2700 K	3991 lm	99093 1 art.	99187 1 art.	99330 1 art.
		3000 K	4270 lm			
		4000 K	4588 lm			
40 W	1100 mA	2700 K	4889 lm	99252 1 art.	99254 1 art.	99254 1 art.
		3000 K	5230 lm			
		4000 K	5620 lm			

ELECTRONICS



99355

EMERGENCY

1 art.

□ 226



SAFE AND EASY MOUNTING

The i-LèD technical laboratories have developed the innovative springs with “smart spring” technology. These springs include both the traditional version and the version with torsion technology and shaped hook. They are the perfect solution for the new i-LèD downlights since they allow quick and simple installation, without damaging the plasterboard or the surface where the downlights are to be mounted. Moreover, they allow to be safely fixed preventing it from accidentally falling also in case of environments exposed to heavy mechanical stresses (e.g. underground stations). The downlights of the COB series, fitted with torsion spring with shaped hook, may be conveniently installed and switched on during the construction phase without the reflector, which will be installed perfectly clean, once the construction works are completed. The i-LèD downlights can be installed on false ceilings with reduced thickness, ranging from 1mm to a maximum of 30 mm.



Torsion spring with shaped hook

- COB20_R
- COB20_Q
- COB65_R
- COB65_Q



Traditional spring

- LV line
- HV line
- COB44_R
- COB44_RJ





downlights LV44_RD



LV44_RD is a recessed line for **general lighting** completely dedicated to **Dynamic White Technology**.

The structure contains a reflective aluminium Optics compartment to increase emission efficiency.

Materials

Steel (bracket)

Aluminum (heat sink and optics)

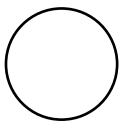

ø 147 mm
10 W

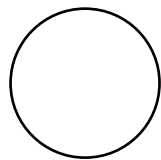

ø 197 mm
20 W

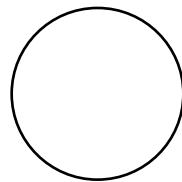

ø 227 mm
30 W

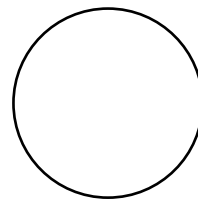

ø 252 mm
44 W

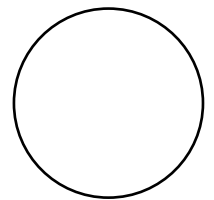

ø 252 mm
70 W

 SMART LIGHTING

The Dynamic White modules, combined with the new specially developed management systems, **allow mixing of the whites from Warm White and Cold White**. It is possible to reproduce, with a single product, all the colour temperatures from 2700K to 6500K, **maintaining the same luminous flux**.

Recent studies on circadian cycles have shown how **variations in the temperature of natural light**, from dawn to dusk, **affect people's well-being**.



2700K

6500K



The LV44 items in the dynamic white version can be managed with a DALI driver with firmware 8.8. This driver allows you to use 8 on the same hardware addresses.

DYNAMIC WHITE TECHNOLOGY

SCIENTIFIC STUDIES HAVE PROVEN THAT REPRODUCING THE SAME FREQUENCIES IN THE INTERIORS OF PUBLIC SPACES CAN BRING BENEFITS TO THOSE LIVING AND WORKING IN THESE PLACES.



LV44_RD1 | Downlight | 10 W 350 mA topLED

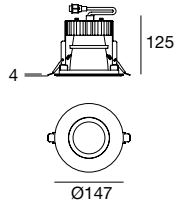

129

Dynamic White

White	91769	2700 K - 6500 K	Dynamic	D	General	00
Black	91776					

ELECTRONICS



99522

DALI
1 art.

LV44_RD2 | Downlight | 20 W 600 mA topLED

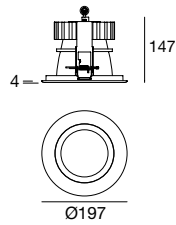

180

Dynamic White

White	91777	2700 K - 6500 K	Dynamic	D	General	00
Black	91778					

ELECTRONICS



99523

DALI
1 art.

LV44_RD3 | Downlight | 30 W 840 mA topLED

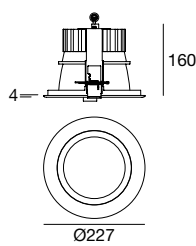

210

Dynamic White

White	91779	2700 K - 6500 K	Dynamic	D	General	00
Black	91780					

ELECTRONICS



99524

DALI
1 art.

LV44_RD4 | Downlight | 44 W 1250 mA topLED

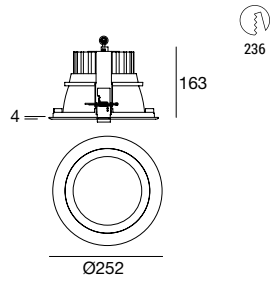

Dynamic White

White	91781	2700 K - 6500 K	Dynamic	D	General	00
Black	91783					

ELECTRONICS



99525

DALI
1 art.

LV44_RD5 | Downlight | 70 W 1800 mA topLED

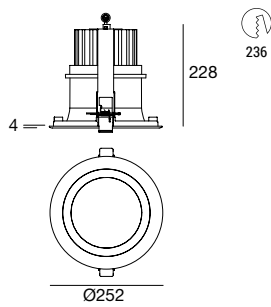

Dynamic White

White	90746	2700 K - 6500 K	Dynamic	D	General	00
Black	90747					

ELECTRONICS



99155

2x DALI
1 art.

CONTROL DIAGRAM EXAMPLE - PAG. 224

99522 10W
99523 20W
99524 30W
99525 44W

Power Bus



99522 / 99523 /
99524 / 99525



Power Bus



99309



Button interface



99311

CONTROL DIAGRAM EXAMPLE - PAG. 224

99155 70W

Power Bus



2 x 99155



Power Bus



99309



Button interface



99311

CEILING & SUSPENDED LINEAR ESSENCE





ceiling & suspended tour



Circular suspension with an essential and rigorous aesthetic. Three types of light: direct, indirect and internal. Available in two installation options, with parallel or stayed cables.

Materials

Calendered and painted aluminum.
Opal polycarbonate diffuser with patented fixing system.



SCALE 1:1
W 38 mm

FINISHING

White
RAL 9003

Black
RAL 9005

Nickel

Concrete

Bronze

Rose gold



The Tour frame is in calendered extruded and powder-coated aluminium.
No visible power cables; the topLEDs are powered through special super-thin cables. The opaline polycarbonate screen is snap-fitted in the profile thanks to a special patented system.

RANGE

Four different diameters characterized by an extra-slim section that makes this suspension the ideal solution for any environment where diffused, uniform light is required.

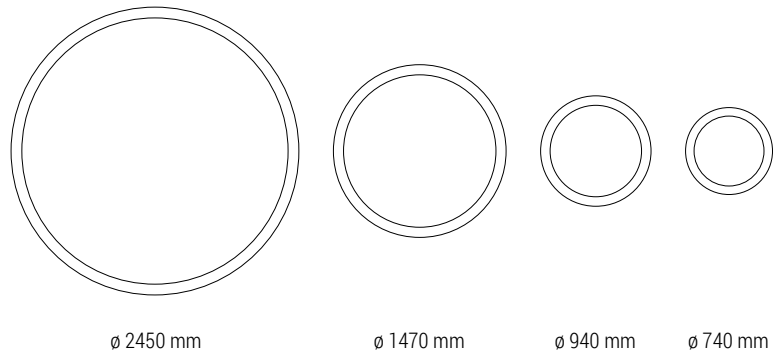

EMISSIONS

Tour offers three different emissions: direct, indirect and lateral internal. Three light effects that can be assembled in countless combinations to customize any room with minimalist and contemporary lighting.

DIRECT EMISSION

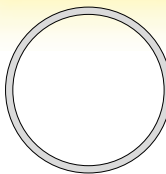

INDIRECT EMISSION

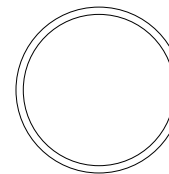

LATERAL INTERNAL EMISSION

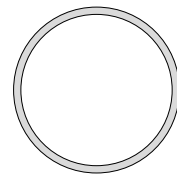

INSTALLATION

The installation system offers different solutions for different types of applications. Tour can be installed with converging cables in a single central rose, or with adjustable hangers to allow proper traction of the cables. An ideal solution also when multiple configurations are required.

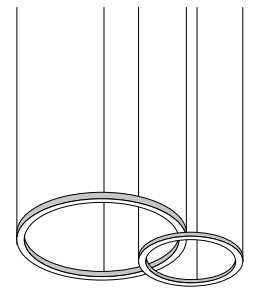
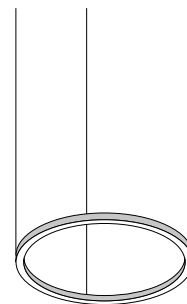
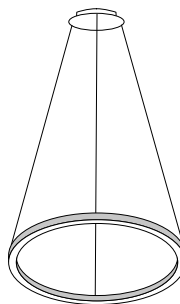

Tour_PD1 | Suspended | 190-250 V | 36 W 24V topLED

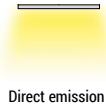
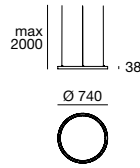

White	64570	3000 K	4678 lm	W	General	00
Black	65112	4000 K	5006 lm	N		
Nickel	65113					
Concrete	65114					
Bronze	65115					
Rosegold	65128					

ELECTRONICS



99374	99074	99077	Installation accessories
ON/OFF	DALI/1-10V interface	PUSH interface	▶ 189

Tour_PD2 | Suspended | 190-250 V | 45 W 24V topLED

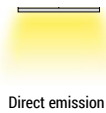
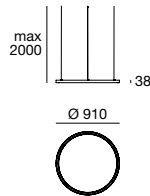

White	64571	3000 K	5847 lm	W	General	00
Black	65116	4000 K	6139 lm	N		
Nickel	65117					
Concrete	65118					
Bronze	65119					
Rosegold	65129					

ELECTRONICS



99374	99074	99077	Installation accessories
ON/OFF	DALI/1-10V interface	PUSH interface	▶ 189

Tour_PD3 | Suspended | 190-250 V | 70 W 24V topLED

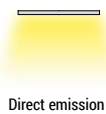
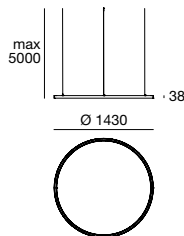

White	64572	3000 K	9355 lm	W	General	00
Black	65120	4000 K	9823 lm	N		
Nickel	65121					
Concrete	65122					
Bronze	65123					
Rosegold	65130					

ELECTRONICS



99374	99074	99077	Installation accessories
ON/OFF	DALI/1-10V interface	PUSH interface	▶ 189

Tour_PD4 | Suspended | 190-250 V | 114 W 24V topLED

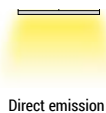
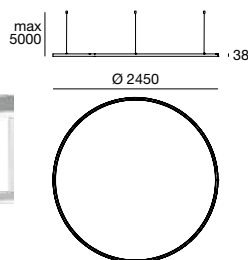
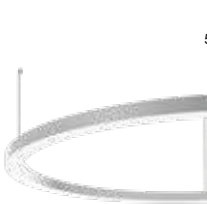

White	64573	3000 K	15588 lm	W	General	00
Black	65124	4000 K	16367 lm	N		
Nickel	65125					
Concrete	65126					
Bronze	65127					
Rosegold	65131					

ELECTRONICS



99331	99332	64576	Installation accessories
ON/OFF	DALI interface	1-10V driver	▶ 189

Tour_PU1 | Suspended | 190-250 V | 36 W 24V topLED

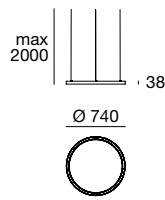

White	64583	3000 K	4678 lm	W	General	00
Black	64682	4000 K	5006 lm	N		
Nickel	64683					
Concrete	64684					
Bronze	64685					
Rose gold	65135					

ELECTRONICS



99374	99074	99077	Installation accessories ▶ 189
ON/OFF	DALI/1-10V interface	PUSH interface	

Tour_PU2 | Suspended | 190-250 V | 45 W 24V topLED

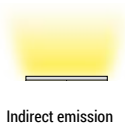
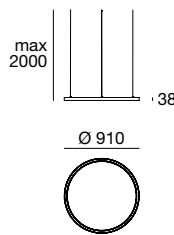

White	64584	3000 K	5847 lm	W	General	00
Black	64686	4000 K	6139 lm	N		
Nickel	64687					
Concrete	64688					
Bronze	64689					
Rose gold	65136					

ELECTRONICS



99374	99074	99077	Installation accessories ▶ 189
ON/OFF	DALI/1-10V interface	PUSH interface	

Tour_PU3 | Suspended | 190-250 V | 70 W 24V topLED

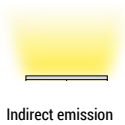
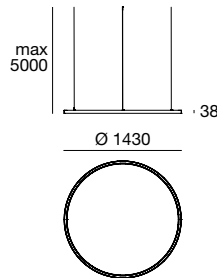
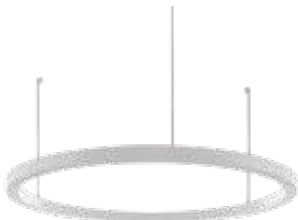

White	64585	3000 K	9355 lm	W	General	00
Black	64690	4000 K	9823 lm	N		
Nickel	64691					
Concrete	64692					
Bronze	64693					
Rose gold	65137					

ELECTRONICS



99374	99074	99077	Installation accessories ▶ 189
ON/OFF	DALI/1-10V interface	PUSH interface	

Tour_PU4 | Suspended | 190-250 V | 114 W 24V topLED

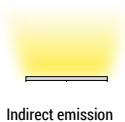
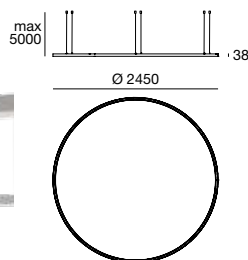

White	64587	3000 K	15588 lm	W	General	00
Black	64694	4000 K	16367 lm	N		
Nickel	64695					
Concrete	64696					
Bronze	64697					
Rose gold	65138					

ELECTRONICS



99331	99332	64576	Installation accessories ▶ 189
ON/OFF	DALI interface	1-10V driver	

Tour_PI1 | Suspended | 190-250 V | 29 W 24V stripLED

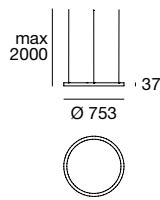

Internal side emission

White	64577	3000 K	3128 lm	W	General	00
Black	65100	4000 K	3220 lm	N		
Nickel	65101					
Concrete	65102					
Bronze	65103					
Rosegold	65132					

ELECTRONICS



99374 ON/OFF
99074 DALI/1-10V interface
99077 PUSH interface

Installation accessories
 ▶ 189

Tour_PI2 | Suspended | 190-250 V | 36,5 W 24V stripLED

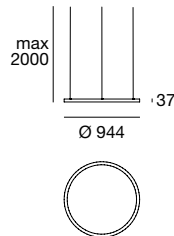

Internal side emission

White	64579	3000 K	3944 lm	W	General	00
Black	65104	4000 K	4060 lm	N		
Nickel	65105					
Concrete	65106					
Bronze	65107					
Rosegold	65133					

ELECTRONICS



99374 ON/OFF
99074 DALI/1-10V interface
99077 PUSH interface

Installation accessories
 ▶ 189

Tour_PI3 | Suspended | 190-250 V | 57,5 W 24V stripLED

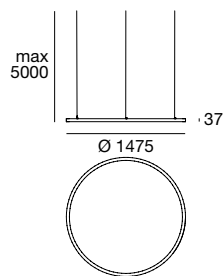
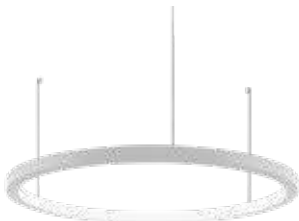

Internal side emission

White	64581	3000 K	6256 lm	W	General	00
Black	65108	4000 K	6440 lm	N		
Nickel	65109					
Concrete	65110					
Bronze	65111					
Rosegold	65134					

ELECTRONICS



99374 ON/OFF
99074 DALI/1-10V interface
99077 PUSH interface

Installation accessories
 ▶ 189

3-point suspension through canopy

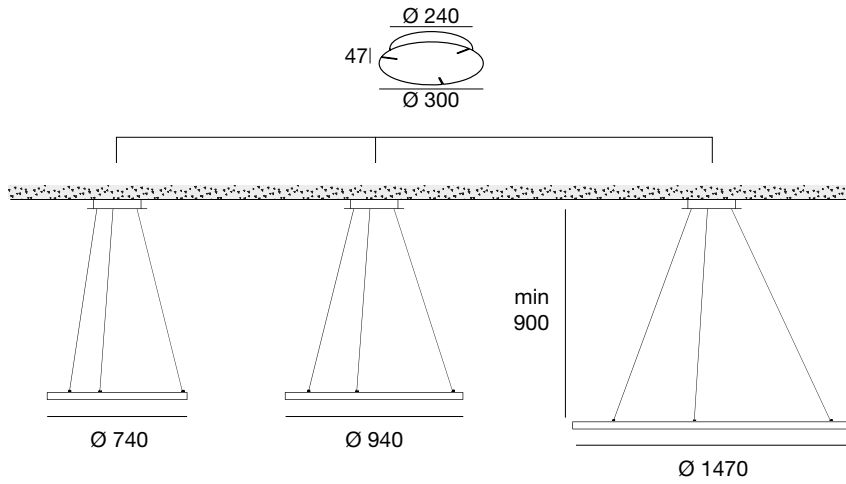

type	suitable for	ON/OFF	DALI
	PD1 - P11 - PU1 PD2 - P12 - PU2 PD3 - P13 - PU3		1-10 V
White	64570 - 64577 - 64583 - 64571 - 64572 - 64579 - 64581 - 64584 - 64585	64578	64586
Black	65112 - 65100 - 64682 - 65116 - 65104 - 64686 - 65120 - 65108 - 64690	65142	65143
Nickel	65113 - 65101 - 64683 - 65117 - 65105 - 64687 - 65121 - 65109 - 64691	65144	65145
Concrete	65114 - 65102 - 64684 - 65118 - 65106 - 64688 - 65122 - 65110 - 64692	65146	65147
Bronze	65115 - 65103 - 64685 - 65119 - 65107 - 64689 - 65123 - 65111 - 64693	65148	65149
Rosegold	65128 - 65132 - 64135 - 65129 - 65133 - 65136 - 65130 - 65134 - 65137	65150	65151

6-point suspension through canopy

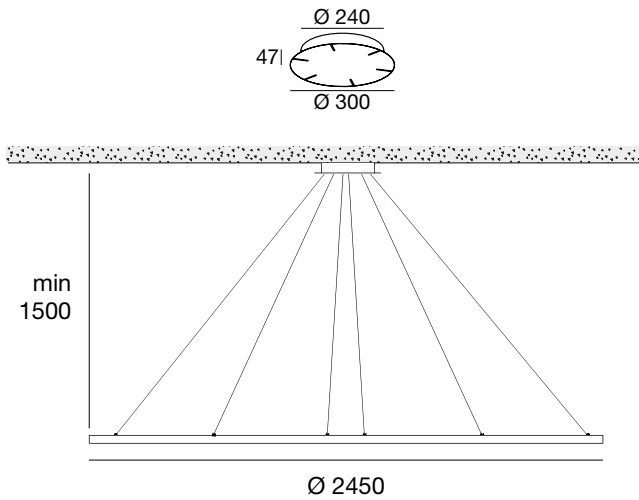

type	suitable for	ON/OFF	DALI
	PD4 - P14 - PU4		
White	64573 - 64587	64580	64588
Black	65124 - 64694	65152	65153
Nickel	65125 - 64695	65154	65155
Concrete	65126 - 64696	65156	65157
Bronze	65127 - 64697	65158	65159
Rosegold	65131 - 65138	65160	65161

3 cones fixing kit

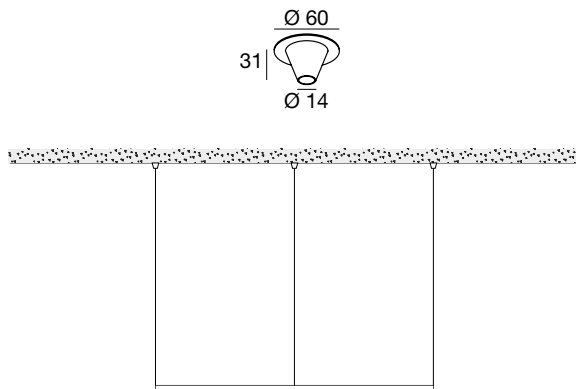

type	
White	64575
Black	64670
Nickel	64671
Concrete	64672
Bronze	64673
Rosegold	65141

For the Ø 2450 version you need 2x fixing kit with 3 cones each.

ceiling & suspended baton



Cylindrical suspension in coated steel, available in various diameters, lengths and finishes. Ideal as a single light point to create **refined and elegant atmospheres**, it can be installed in compositions of different sizes, finishes or heights.

Light control is facilitated by a special integrated lens, visual comfort is guaranteed by the backward position of the LED source.

Materials

Coated steel

RANGE

Two sections in four different lengths characterize the versions available in the range. Extremely minimal when used individually, Baton is able to create impressive light scenarios if combined in more modules, playing with the various shapes available.

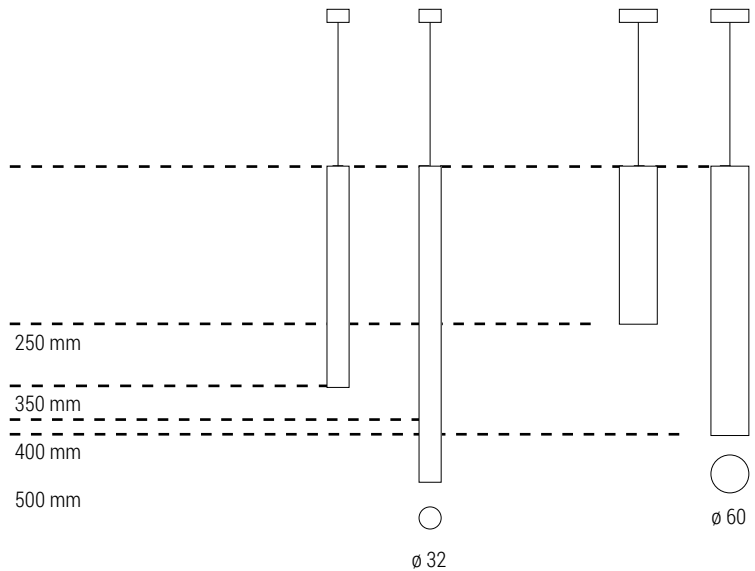

CONTROLLED EMISSION

Baton creates high-contrast lighting effects. Through the lens integrated inside the body, the light beam is characterized by sharp edges, effectively emphasizing the lit items. The backward position of the LED makes this suspension extremely comfortable to the eye, and ideal for tables and bar counters in particular.

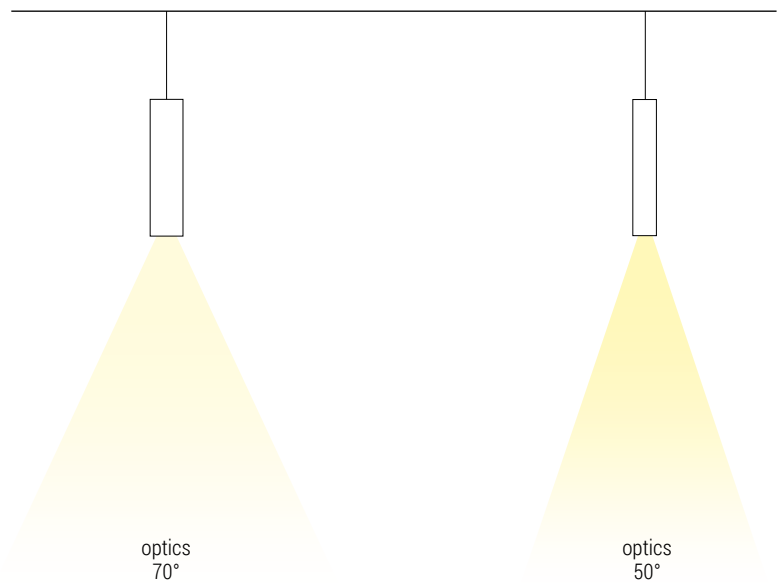

FINISHES

Powder-coated in a matt white or matt black finish, the aluminium bodies blend perfectly with the architectural space. The inner part of the Optics unit characterizes the product with a touch of colour, matt black and matt gold.

Exterior matt white/black
Interior Optics matt black/gold



Baton_P1 | Suspended | 190-250 V | 7 W arrayLED | 8 W AC device

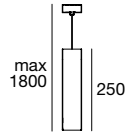

Ø 60 |

White	Bk	64742	3000 K	988 lm	W	W. Flood	70
White	Au	64741	4000 K	1058 lm	N		
Black	Au	64754					

Baton_P2 | Suspended | 190-250 V | 7 W arrayLED | 8 W AC device

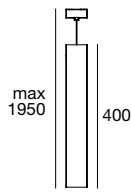

Ø 60 |

White	Bk	64744	3000 K	988 lm	W	W. Flood	70
White	Au	64743	4000 K	1058 lm	N		
Black	Au	64755					

Baton_P3 | Suspended | 190-250 V | 2,5 W arrayLED | 3 W AC device

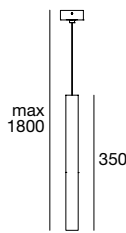

Ø 32 |

White	Bk	64785	3000 K	325 lm	W	Flood	50
White	Au	64786	4000 K	351 lm	N		
Black	Au	64787					

Baton_P4 | Suspended | 190-250 V | 2,5 W arrayLED | 3 W AC device

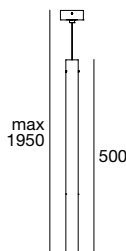

Ø 32 |

White	Bk	64782	3000 K	325 lm	W	Flood	50
White	Au	64783	4000 K	351 lm	N		
Black	Au	64784					



Ceiling & Suspended

ceiling & suspended TU-0 / TU-V

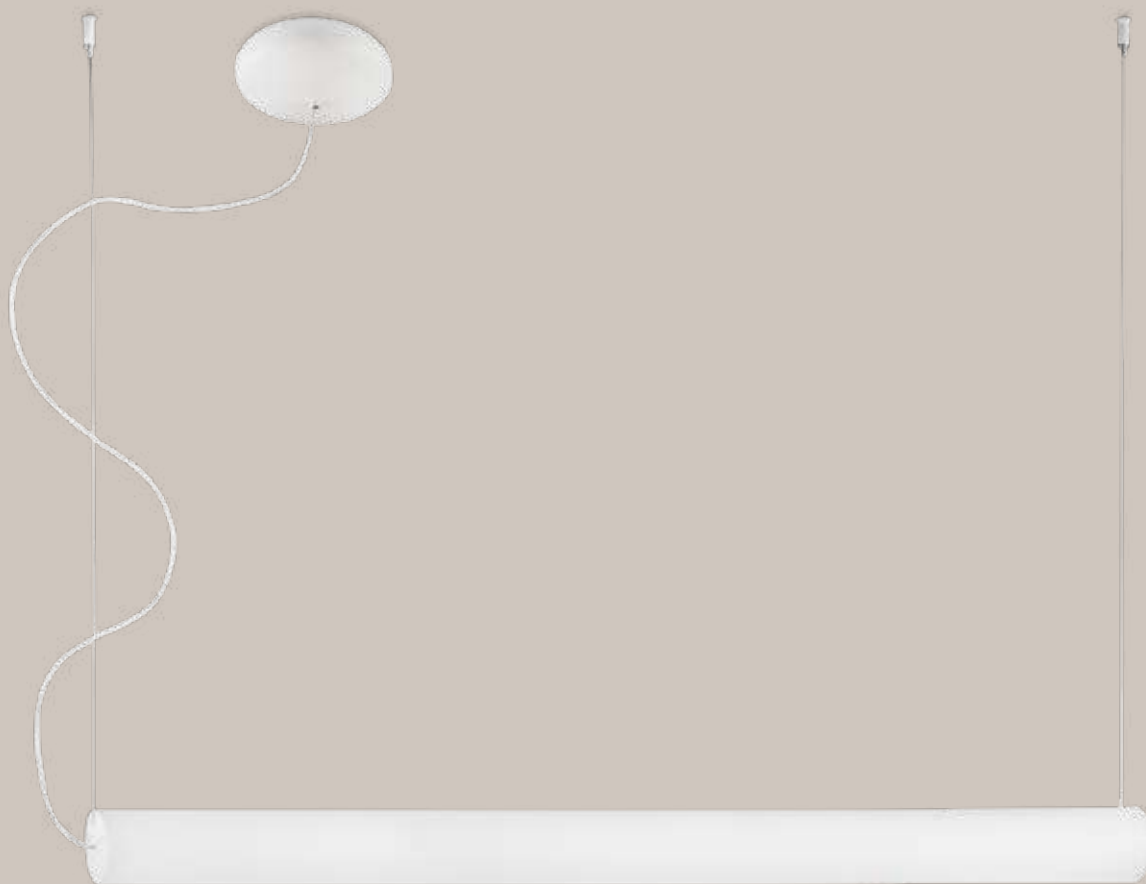

Vertical or horizontal tubular light in different lengths.

Modular in vertical waterfalls or intricate luminous forest-like ceiling compositions. Essential light sculpture.

Materials

Diffuser in natural polyethylene, closing end caps in white wrinkle-effect coated aluminium.

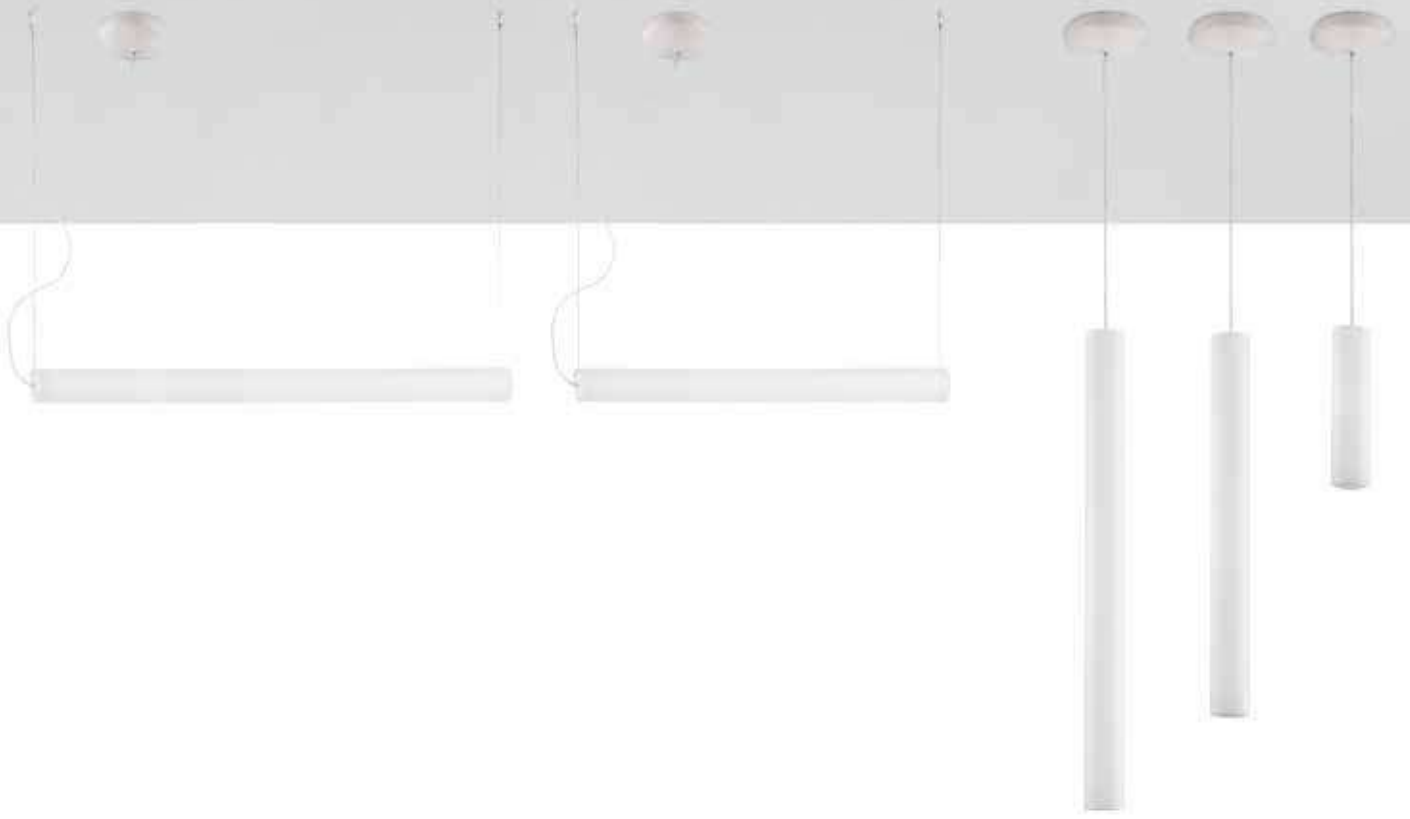

Tu-O | Suspended | 220-240 V | 36 W 700 mA topLED



White 8198 3000 K 4662 lm General

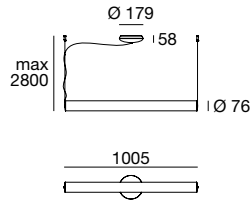

Tu-O | Suspended | 220-240 V | 56 W 1050 mA topLED



White 8199 3000 K 6993 lm General

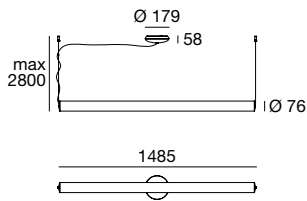

Tu-V | Suspended | 220-240 V | 20 W 350 mA topLED



White 8195 3000 K 2331 lm General

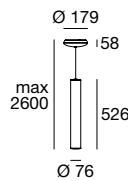

Tu-V | Suspended | 220-240 V | 36 W 700 mA topLED



White 8196 3000 K 4662 lm General

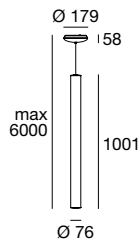

Tu-V | Suspended | 220-240 V | 54 W 350 mA topLED



White 8197 3000 K 6993 lm General





Ceiling & Suspended

ceiling & suspended straight _p

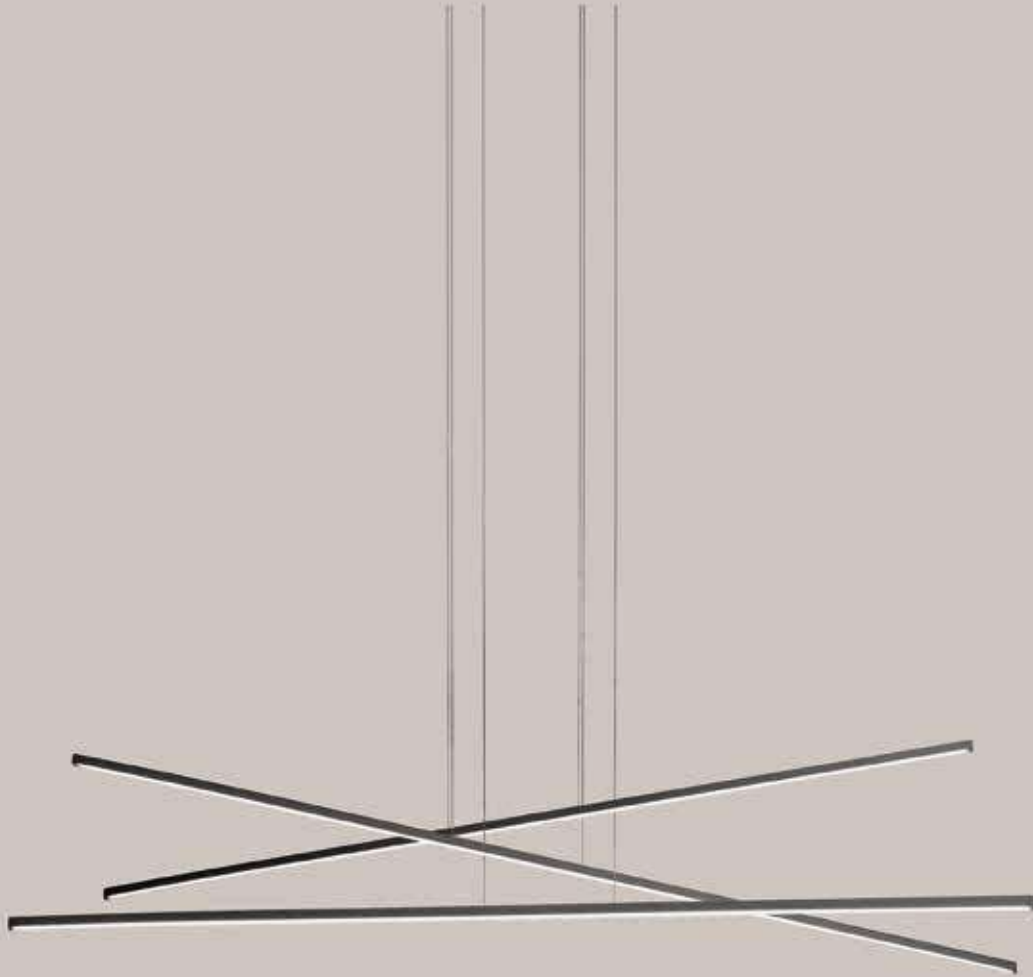

Linear essence. One or three ultra-thin suspension light lines that can be combined imaginatively. Everything is elegantly minimal in its simplicity.

Materials

Frame in white or black wrinkle-effect coated aluminium, polycarbonate diffuser

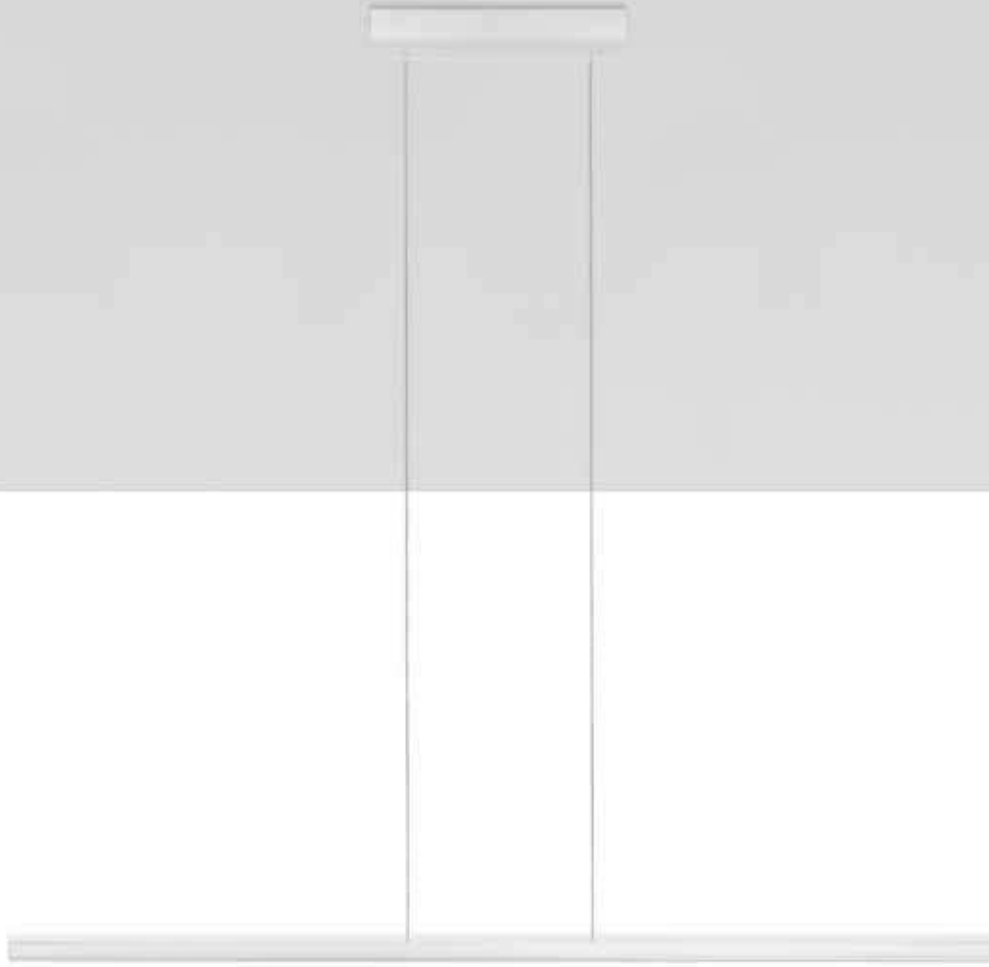

STRAIGHT_P
NARROW EMISSION



Diffuser inserted internally

STRAIGHT_P
DIFFUSED



Diffuser inserted externally

Straight_P1 | Suspended | 220-240 V | 11 W 350 mA topLED

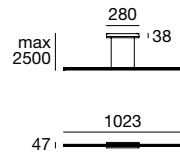
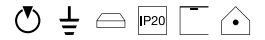

White	8200	2700 K	1519 lm	W	General	00
Black	8204					

Straight_P1 | Suspended | 220-240 V | 18 W 350 mA topLED

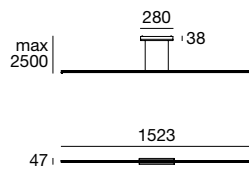

White	8201	2700 K	2279 lm	W	General	00
Black	8205					

Straight_P3 | Suspended | 220-240 V | 34 W 1050 mA topLED

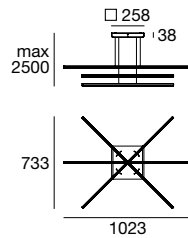
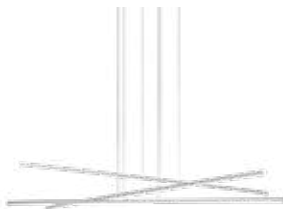
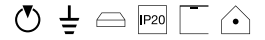

White	8202	2700 K	4557 lm	W	General	00
Black	8206					

Straight_P3 | Suspended | 220-240 V | 49 W 1050 mA topLED

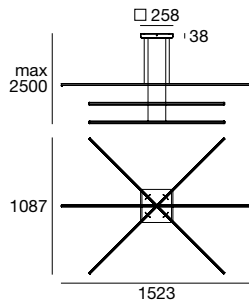
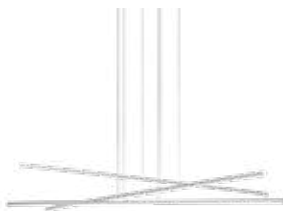

White	8203	2700 K	6836 lm	W	General	00
Black	8207					



Ceiling & Suspended

ceiling & suspended oh!



The perfection of the sphere, the naturalness of light, the pleasant presence in every space: alone or in combination, a suspension light that decorates and illuminates with simplicity and spontaneity.

Materials

Casing for diffused lighting in white linear polyethylene; base in white linear polyethylene.

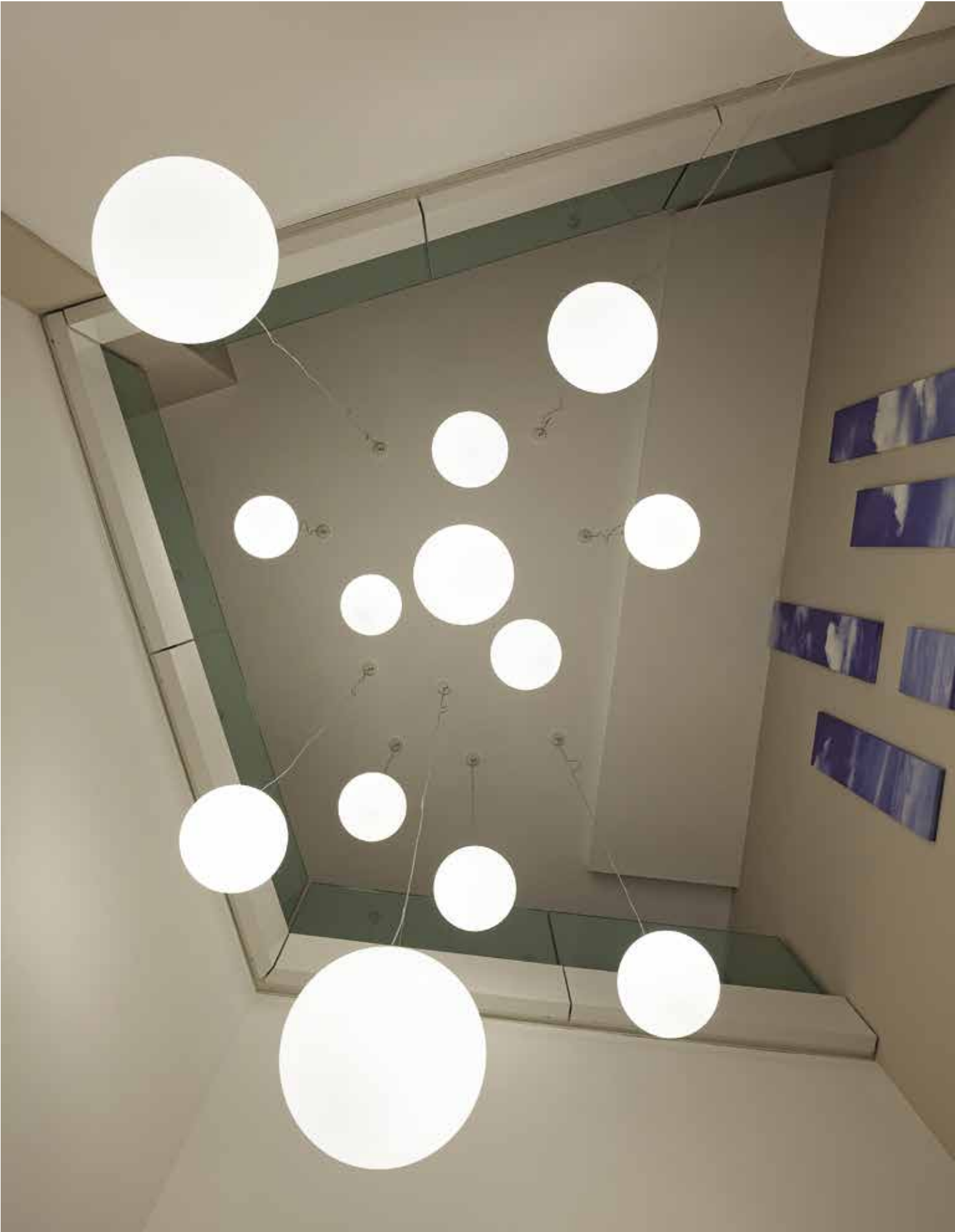

Oh!_P | Suspended | 220-240 V | 8 W 350 mA topLED

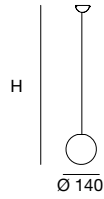

White	10114	3000 K	994 lm	CRI 90	Diffused	3 m
White	10114.01					5 m
White	10114.02					10 m

Oh!_P | Suspended | 220-240 V | 8 W 350 mA topLED

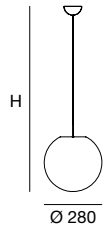

White	10135	3000 K	1002 lm	CRI 90	Diffused	2.2 m
White	10135.01					5 m
White	10135.02					10 m

Oh!_P | Suspended | 220-240 V | 15 W 350 mA topLED

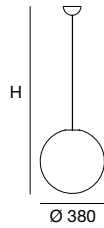

White	10136	3000 K	1893 lm	CRI 90	Diffused	2.3 m
White	10136.01					5 m
White	10136.02					10 m

Oh!_P | Suspended | 220-240 V | 20 W 500 mA topLED

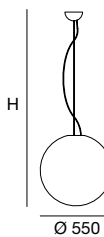

White	10137	3000 K	2652 lm	CRI 90	Diffused	2.5 m
White	10137.01					5 m
White	10137.02					10 m

Oh!_P | Suspended | 220-240 V | 29 W 700 mA topLED

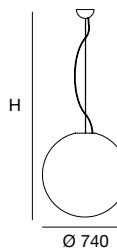

White	10138	3000 K	3674 lm	CRI 90	Diffused	2.7 m
White	10138.01					5 m
White	10138.02					10 m

Oh!_PMX | Suspended | 220-240 V | 17 W 350 mA topLED

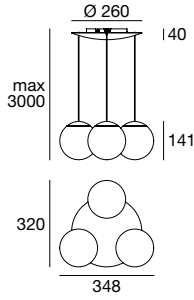

17 W 350 mA - CRI 90

CCT

optic

White

10117

3000 K 2181 lm

General

Oh!_S | Ceiling | 220-240 V | 6 W 350 mA topLED



White

10131

3000 K 1002 lm

General

Oh!_S | Ceiling | 220-240 V | 15 W 350 mA topLED

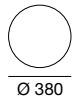

White

10132

3000 K 1893 lm

General

Oh!_S | Ceiling | 220-240 V | 20 W 350 mA topLED

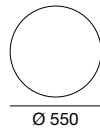

White

10133

3000 K 2652 lm

General

Oh!_S | Ceiling | 29 W 350 mA topLED

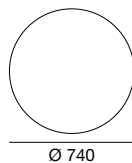

White

10134

3000 K 3674 lm

General





ceiling & suspended box

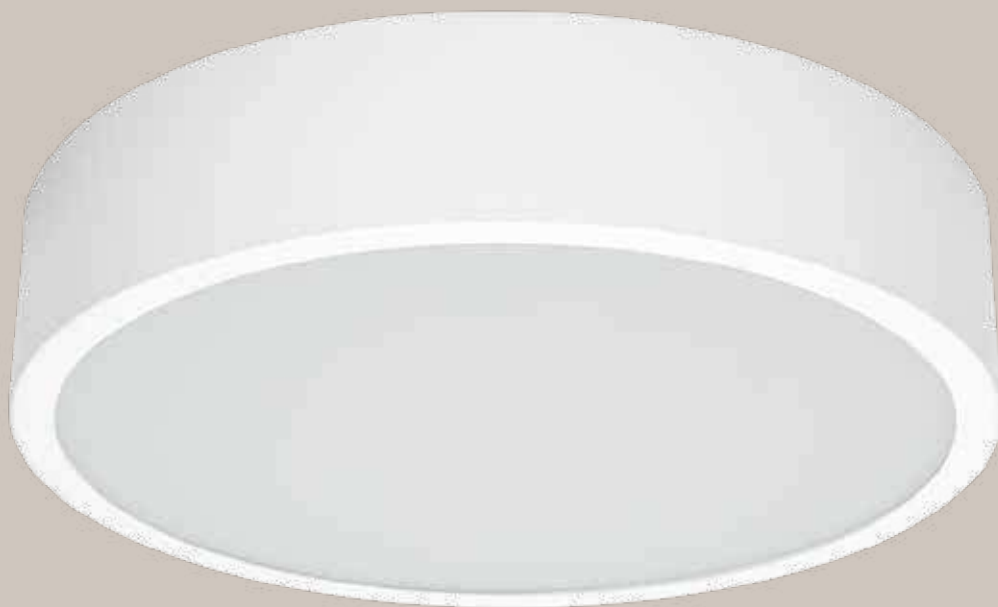

Ceiling and wall lights defined by **minimal** and **versatile shapes** give way to light, a true protagonist with a discreet presence.

Materials

White wrinkle-effect coated metal frame, available also with gray, chrome, nickel or dark cement finishes;
Satin-finished polymethylmethacrylate diffuser.



Box_SR | Ceiling Lights | 220-240 V | 7 W 500 mA topLED

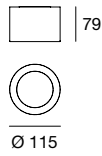

White	8236	3000 K	752 lm	General
Black	8237			
White	8236N	4000 K	811 lm	General
Black	8237N			



KIT0026

Box_SR | Ceiling Lights | 220-240 V | 17 W 500 mA topLED

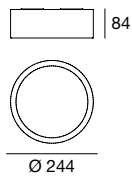

White	8238	3000 K	1880 lm	General
Black	8239			
White	8238N	4000 K	2027 lm	General
Black	8239N			



KIT0026

Box_SR | Ceiling Lights | 220-240 V | 25 W 700 mA topLED

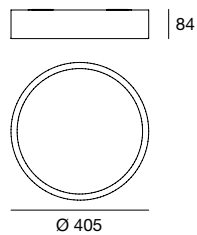

White	8240	3000 K	2878 lm	General
Black	8241			
White	8240N	4000 K	3108 lm	General
Black	8241N			



KIT0026

Box_SR | Ceiling Lights | 220-240 V | 48 W 1000 mA topLED

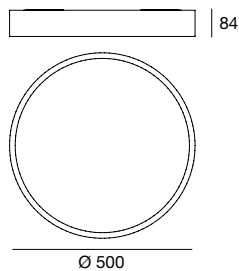

White	8242	3000 K	5232 lm	General
Black	8243			
White	8242N	4000 K	5650 lm	General
Black	8243N			



KIT0026

Box_SQ | Ceiling Lights | 220-240 V | topLED 7 W 500 mA

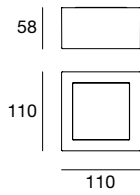

White	8227	3000 K	752 lm	Diffused
Black	8228			
White	8227N	4000 K	811 lm	Diffused
Black	8228N			



KIT0026

Box_SQ | Ceiling Lights | 220-240 V | topLED 17 W 700 mA

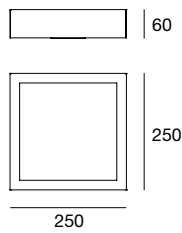

White	8229	3000 K	1880 lm	Diffused
Black	8230			
White	8229N	4000 K	2027 lm	Diffused
Black	8230N			



KIT0026

Box_SQ | Ceiling Lights | 220-240 V | topLED 25 W 700 mA

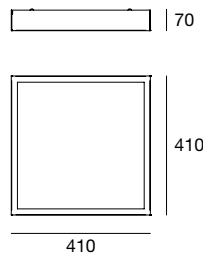

White	8231	3000 K	3060 lm	Diffused
Black	8232			
White	8231N	4000 K	3283 lm	Diffused
Black	8232N			



KIT0026

Box_SQ | Ceiling Lights | 220-240 V | topLED 43 W 500 mA

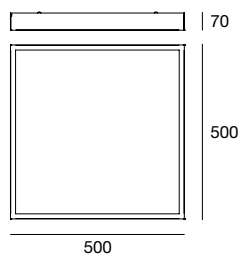

White	8233	3000 K	4888 lm	Diffused
Black	8234			
White	8233N	4000 K	5270 lm	Diffused
Black	8234N			



KIT0026

ELECTRONICS CREATING CONNECTIONS

Defender | Over voltage protection

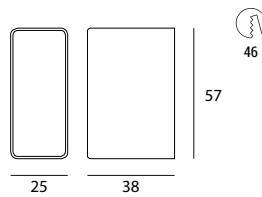
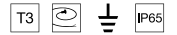

UN	IN	IMAX	ITOT	Uoc	UP	
230V AC	5kA	10kA	20kA	10kV	≤ 1.5kV	99341

U_n	Nominal operating Voltage
I_n	Nominal impulse discharge current
I_{max}	Total impulse current (L+N+PE)
I_{tot}	Max. total impulse current (L+N+PE)
U_{oc}	Surge protection level [L-N] [L+N+PE]
UP	Voltage protection level [L-N] [L/N-PE]

Surge arrester for T3 type indirect discharges (CEI EN 61643-11 / A11) with test classification III (CEI EN 61643-11 Ed.1).

Multi-pole overvoltage arrester with spark gap and varistors connected in series to the active phases.

Combined voltage limiting and switching SPD

No leakage current.

No secondary mains current due to the combined varistor/spark gap series.

INSTALLATION RULES

The installation of a single arrester upstream on each line may not be sufficient to guarantee effective protection for the entire system.

All luminaires installed at a distance of 10 m downstream of the arrester are considered to be 100% protected.

If the length of the cable between the arrester and the luminaires exceeds 10 m, it is recommended to renew the protection by placing another arrester near the devices to be protected (within 10 m).

In order to guarantee the maximum level of protection, install the arresters in the manner described above for each line of the appliance.

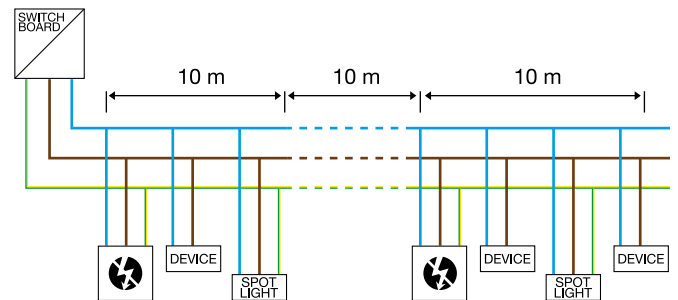
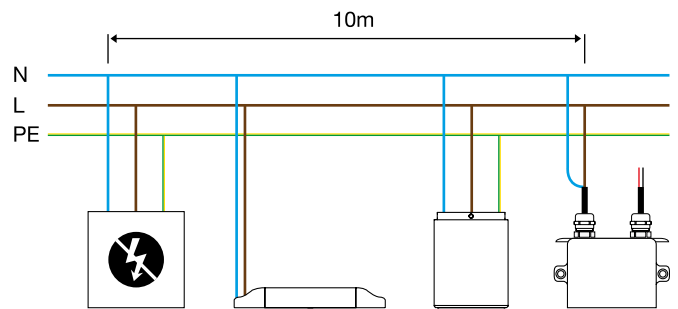



Bit | On/Off Driver 100~240V AC / 180~275V DC

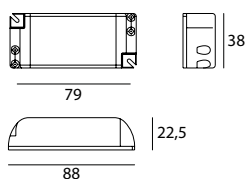

44

range	output	input	eff.	PF	surge	
7 W arrayLED	700mA 10V	100~240V AC	80%	0.6 C	0.5 kV	99243
10 W arrayLED	300mA 36V	100~240V AC	80%	0.6 C	0.5 kV	99370

Self-resetting protection against overheating, overload, open circuit and short-circuit on the output line.

Slim | On/Off Driver 190~250V AC / 180~275V DC

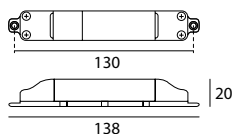

29

range	output	input	eff.	PF	surge	
1-2 W powerLEDs	350mA 6.6V	190~250V AC	80%	0.6 C	4 kV	89144
2-4 W powerLEDs	630mA 6.6V	190~250V AC	80%	0.6 C	4 kV	89147

Instantaneous output current limitation for LED protection at power up. A switch may be integrated on the output line. Self-resetting protection against output overheating, overload, open circuit and short-circuit on the output line.

Mini_Penny | On/Off Driver 190~250V AC / 260~360V DC

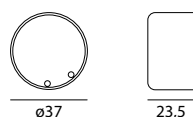
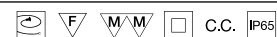

37

range	output	input	eff.	PF	surge	
1-2 W powerLEDs	350mA 6.6V	190~250V AC	80%	0.6 C	0.5 kV	89148
2-4 W powerLEDs	630mA 6.6V	190~250V AC	80%	0.6 C	0.5 kV	89151

Self-resetting protection against overheating, overload, open circuit and short-circuit on the output line.

Leon | On/Off Driver 180~300V AC

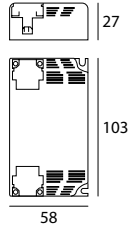

range	output	input	eff.	PF	surge	
18 W arrayLED	500mA 37V	180~300V AC	91%	0.95	4 kV	99106
25 W arrayLED	720mA 37V	180~300V AC	91%	0.95	4 kV	99147
33 W arrayLED	950mA 37V	180~300V AC	91%	0.95	4 kV	99239

Smartwave™: excellent efficiency, long operating life, surge protection, high PF.

Protection against overheating, overload, open circuit and short-circuit on the output line.

Leon_Easy-Plug | On/Off Driver 180~300V AC

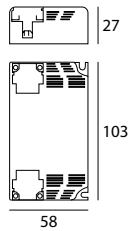

range	output	input	eff.	PF	surge	
15 W arrayLED	400mA 37V	180~300V AC	91%	0.95	4 kV	99113
25 W arrayLED	720mA 37V	180~300V AC	91%	0.95	4 kV	99112
30 W arrayLED	840mA 37V	180~300V AC	91%	0.95	4 kV	99093

Easy Plug connector included. Smartwave™: excellent efficiency, long operating life, surge protection, high PF.

Protection against overheating, overload, open circuit and short-circuit on the output line.

Clerk | On/Off Driver 180~300V AC

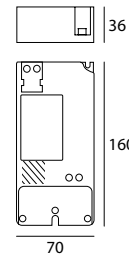

range	output	input	eff.	PF	surge	
40 W arrayLED	1.1A 37V	180~300V AC	92%	0.98	5 kV	99252

Easy Plug connector included. Smartwave™: excellent efficiency, long operating life, surge protection, high PF.

Protection against overheating, overload, open circuit and short-circuit on the output line.

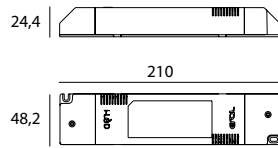
Boson | N/O button 1-10V Multi Power 190~250V AC / 180~275V DC

range	output	input	eff.	PF	surge
1-15 W powerLEDs	350mA 45V	190~250V AC	87%	0.6 C	4 kV 99115
18 W arrayLED	500mA 37V	190~250V AC	87%	0.6 C	4 kV

Selection of output current intensity via dedicated terminal.
Self-resetting protection against over-temperature, overload, open circuit and short-circuit on the output line.
Settings via 1-10V interface, potentiometer, or N/A button. Possibility of connecting up to 50 drivers (via the Sync bus).

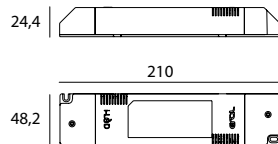
Boson_Easy-Plug | N/O button 1-10V Multi Power 190~250V AC / 180~275V DC

range	output	input	eff.	PF	surge
15 W arrayLED	400mA 37V	190~250V AC	87%	0.6 C	4 kV 99116
23 W topLED	630mA 36V	190~250V AC	87%	0.6 C	4 kV 99262

Easy Plug connector included. Selection of output current intensity via dedicated terminal. Self-resetting protection against over-temperature, overload, open circuit and short-circuit on the output line. Settings via 1-10V interface, potentiometer, or N/A button.
Possibility of connecting up to 50 drivers (via the bus Sync).

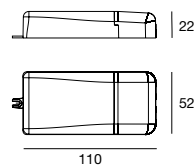
Mini Jolly | 1-10V Multi Power 110~240V AC / 176~280V DC

range	output	input	eff.	PF	surge
11 W arrayLED	300mA 33V	220~240V AC	87%	0.95	0.5 kV 99572

Light regulation 0/0,5 - 100 %.
Interface (I=0,35 mA) or 100 Kohm potentiometer.
Multipower driver supplied with dip-switch for the selection of the output current. Protections against overheating and short circuits, against mains voltage spikes and against overloads.

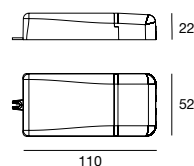
Mini Jolly DALI | DALI Multi Power 110~240V AC / 176~280V DC

range	output	input	eff.	PF	surge
11 W arrayLED	300mA 33V	220~240V AC	87%	0.95	0.5 kV 99573

Features DALI dimming (0/0,5 - 100 %), compatible with standard DALI interfaces. Multipower driver supplied with dip-switch for the selection of the output current. Protections against overheating and short circuits, against mains voltage spikes and against overloads.

Planck | DALI Multi Power 100~240V AC

F M/M C.C. DALI IP40

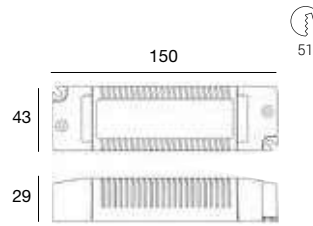

range	output	input	eff.	PF	surge
1 - 12 W arrayLED	350mA 34V	100~240V AC	84%	0.9 C	4 kV 99373
1.5 - 12 W powerLED	500mA 24V				
1.5 - 12 W powerLED	600mA 20V				

DALI interface, suitable for 6W, 8W or 2 articles in series from 6W.
Electrical output intensity selected by dip-switch.

Photon | Push and Simply Dim DALI Multi Power 190~250V AC / 180~275V DC

F M/M C.C. Simply Dim DALI IP40

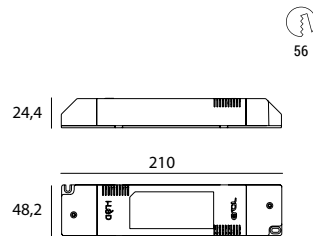

range	output	input	eff.	PF	surge
1-15 W powerLEDs	350mA 45V	190~250V AC	87%	0.6 C	4 kV 99114
18 W arrayLED	500mA 37V	190~250V AC	87%	0.6 C	4 kV
2-20 W powerLEDs	630mA 39V	190~250V AC	87%	0.6 C	4 kV

Settings via DALI interface or Simply Dim.
Optimization of the DALI transmission signal (burst immunity up to 4 kV).
Selection of current intensity via dedicated terminal.
Self-resetting protection against over-temperature, overcharge, open circuit and short-circuit on the output line.

Photon_Easy-Plug | Push and Simply Dim DALI Multi Power 190~250V AC / 180~275V DC

F M/M C.C. Simply Dim DALI IP40

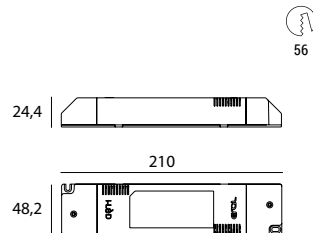

range	output	input	eff.	PF	surge
15 W arrayLED	400mA 37V	190~250V AC	87%	0.6 C	4 kV 99131

Settings via DALI interface or Simply Dim.
Optimization of the DALI transmission signal (burst immunity up to 4 kV).
Selection of current intensity via dedicated terminal.
Self-resetting protection against over-temperature, overcharge, open circuit and short-circuit on the output line.

Argo | Push and Simply Dim DALI Multi Power 190~250V AC / 180~275V DC

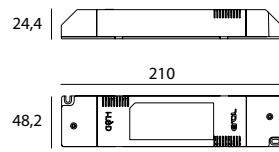

range	output	input	eff.	PF	surge	
2-24 W powerLED	630mA 39V	190~250V AC	87%	0.95	4 kV	99344
25 W arrayLED	720mA 37V	190~250V AC	87%	0.95	4 kV	99345
35 W arrayLED	950mA 37V	190~250V AC	87%	0.95	4 kV	

Settings via DALI interface or Simply Dim.
 Optimization of the DALI transmission signal (burst immunity up to 4 kV).
 Selection of current intensity via dedicated terminal.
 Self-resetting protection against over-temperature, overcharge, open circuit and short-circuit on the output line.

Argo_Easy-Plug | Push and Simply Dim DALI Multi Power 190~250V AC / 180~275V DC

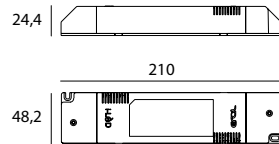

range	output	input	eff.	PF	surge	
25 W arrayLED	720mA 37V	190~250V AC	87%	0.95	4 kV	99330
30 W arrayLED	840mA 37V	190~250V AC	87%	0.95	4 kV	

Settings via DALI interface or Simply Dim.
 Optimization of the DALI transmission signal (burst immunity up to 4 kV).
 Selection of current intensity via dedicated terminal.
 Self-resetting protection against over-temperature, overcharge, open circuit and short-circuit on the output line.

Serban | Push and Simply Dim 1-10V DALI Multi Power 190~250V AC / 180~275V DC

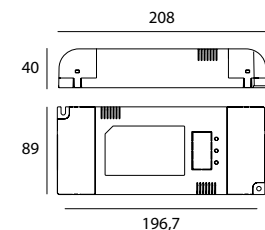

range	output	input	eff.	PF	surge	
25 W arrayLED	720mA 37V	190~250V AC	86%	0.95	4 kV	99268

Settings via DALI interface, 1-10V, Simply DIM.
 Optimization of the DALI transmission signal (up to 4 kV burst immunity).
 Possibility to choose between linear or logarithmic dimming, using a jumper.

Serban_Easy-Plug | Push and Simply Dim DALI 1-10V Multi Power 190~250V AC / 180~275V DC

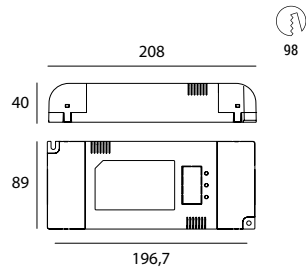

range	output	input	eff.	PF	surge	
25 W arrayLED	720mA 37V	190~250V AC	86%	0.95	4 kV	99188
30 W arrayLED	840mA 37V	190~250V AC	86%	0.95	4 kV	99187
35 W arrayLED	950mA 37V	190~250V AC	86%	0.95	4 kV	99241
40 W arrayLED	1.1A 37V	190~250V AC	86%	0.95	4 kV	99254

Settings via DALI interface, 1-10V, Simply DIM.
 Optimization of the DALI transmission signal
 (up to 4 kV burst immunity).
 Possibility to choose between linear or logarithmic dimming,
 using a jumper.

DUALdrive 560/A| DALI Multi Power 120~277V AC / 120~240V DC

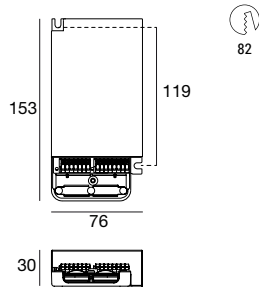

range	output	input	eff.	PF	surge	
10 W topLED	350mA 39V	120~277V AC	89%	0.9 C	2 kV	99522
20 W topLED	600mA 39V	120~277V AC	89%	0.9 C	2 kV	99523
30 W topLED	840mA 39V	120~277V AC	89%	0.9 C	2 kV	99524
44 W topLED	1.25A 39V	120~277V AC	89%	0.9 C	2 kV	99525

Settings via DALI interface.

Theo | Push and Simply Dim 1-10V DALI Multi Power 180~300V AC

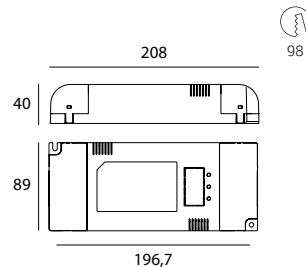

range	output	input	eff.	PF	surge	
66 W topLED	1.8A 37V	180~300V AC	90%	0.95	5 kV	99155

range	output	input	eff.	PF	dim
6 W arrayLED	500mA 12,5V	100~240V AC	84%	0.9 C	1:100%
12 W powerLED	500mA 24V	100~240V AC	84%	0.9 C	1:100%
8 W powerLED	600mA 12,5V	100~240V AC	84%	0.9 C	1:100%

Smartwave™: excellent efficiency, long operating life, surge protection, high PF.
 Settings via DALI interface, 1-10V, Simply DIM.

Reson_150 | On/Off Driver 190~250V AC / 180~275V DC 150 W

range	output	input	eff.	PF	surge	
1-150 W topLED	6.25A 24V	190~250V AC	95%	0.98	5 kV	99331

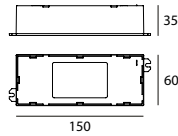

Suitable for powering LED strips at constant voltage.
Self-resetting protection against output open circuit and short-circuit on the output line.
High efficiency, long operating life and high PF.

Reson_75 | On/Off Driver 190~250V AC / 180~275V DC 75 W

range	output	input	eff.	PF	surge	
1-75 W topLED	3.12A 24V	190~250V AC	91%	0.96	4 kV	99374

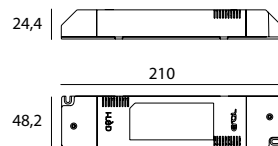

Suitable for powering LED strips at constant voltage.
Self-resetting protection against output open circuit and short-circuit on the output line.
High efficiency, long operating life and high PF.

Nyquist | N/O button Multi Channel 3ch. 24V DC 216 W

range	output	input	eff.	
3ch. x (1-72 W topLED/ch.)	3A 24V	24V DC	95%	99077

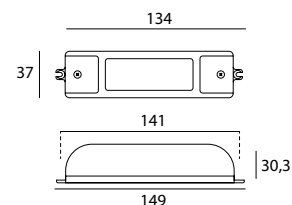

Suitable for powering LED strips, LEDs 5 mm and topLED at constant voltage.
Dimming from 0 to 100% using the N/A button.
Each Driver can perform as a master or as a slave.
Up to 20 drivers may be connected via the Sync bus.

Bode | DALI 1-10V Multi Channel 3ch. 24V DC 216 W

range	output	input	eff.	
3ch. x (1-72 W 5mmLED/ch.)	3A 24V	24V DC	95%	99074
3ch. x (1-72 W stripLED/ch.)	3A 24V	24V DC	95%	
3ch. x (1-72 W topLED/ch.)	3A 24V	24V DC	95%	

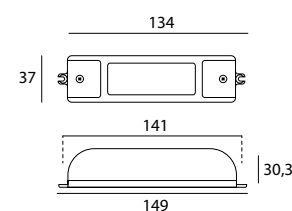

Suitable for powering LED strips, 5 mm LEDs and topLED at constant voltage. Adjustment via DALI interface, 1-10V or potentiometer.

Ervin | Converter 24 V 120 W



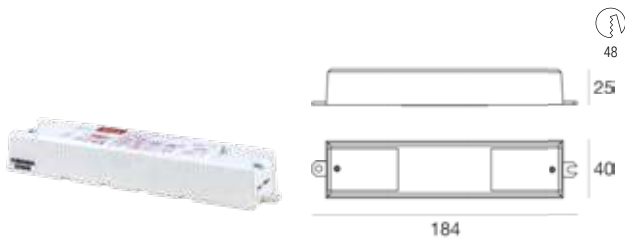

 C.V.  

range	output	input	eff.	PF	surge
1-120 W topLEDs	5A 24 V	24 V DC	95%	0.9 C	4 kV 64576

Suitable for powering StripLEDs and TopLEDs at constant voltage.
Adjustment via DALI interface.

Reson_150_1-10V | 1-10V Driver 190~250V AC / 180~275V DC 150 W



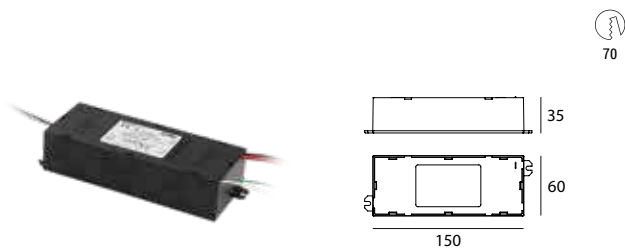

 C.V.  

range	output	input	eff.	PF	surge
1-150 W topLED	6.25A 24V	190~250V AC	95%	0.98	5 kV 99332

Suitable for powering LED strips at constant voltage.
Self-resetting protection against output open circuit and short-circuit on the output line.
Adjustment via DALI interface, 1-10V or potentiometer.

Dali_PS1 | DALI Controller

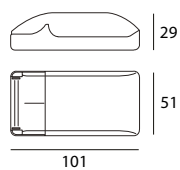

DALI Power Supply

Transp. **99309** 230~240V AC CLAMP DALI Power Supply

Driver for 200 mA DALI BUS for DALI devices or control modules without power supply.
Driver for recessed mounting.

Dali_PS2 | DALI Controller

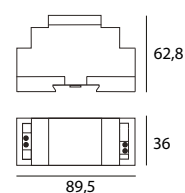

DALI Power Supply

White **99310** 230~240V AC CLAMP DALI Power Supply

Driver for 240 mA DALI BUS for DALI devices or control modules without power supply.
Driver suitable to be mounted on a 35mm DIN Omega track.

Dali_USB | DALI Controller

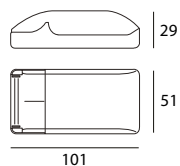
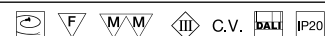

DALI Power Supply

Transp. **99308** 4.5~5V DC CLAMP DALI

PC/DALI interface.

It allows connecting a PC to the DALI system interface, addressing the individual drivers, managing scenes and groups.
The system must be integrated with free software "masterCONFIGURATOR".
Power supply through DALI cable and USB interface.

Dali_XC | DALI Controller

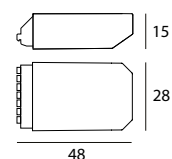
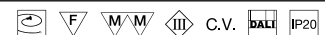

DALI Power Supply

White **99311** 15~16V DC CLAMP DALI



99309
Alimentatore

4 separate inputs for contacts/N.O. buttons.
Mode controlled via 2 rotary selectors.
Possibility to connect several DALI XC on the DALI line.
Power supply through DALI cable.
25 cm long connection cables depending on the terminal colours included.

Dali_Msensor | DALI Controller

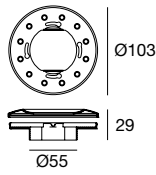

DALI Power Supply

White **99312** 15~16V DC CLAMP DALI



Control based on ambient light and motion detection.
 Assignment of simple group through rotary switch.
 Possibility to connect several MSensors in a group and on the DALI line.
 It can be controlled remotely.
 Lighting and motion detection controls can be deactivated.
 Parameter control through configuration software.
 Power supply through DALI cable.

Dali_Msensor | DALI Controller

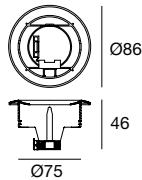

DALI Power Supply

White **99313** 15~16V DC CLAMP DALI



Control based on ambient light and motion detection.
 Assignment of simple group through rotary switch.
 Possibility to connect several MSensors in a group and on the DALI line.
 It can be controlled remotely.
 Lighting and motion detection controls can be deactivated.
 Parameter control through configuration software.
 Power supply through DALI cable.

Dali_RC | Remote Control and IR Controller

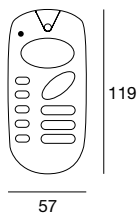

DALI Power Supply

Black **99334**

Accessory for DALI MSensor 99312 and 99313.
 Optional IR remote control.
 Switching on, switching off and dimming.
 Activation of automatic control of lighting (LUX).
 Retrieving five output values of fixed light.
 Individual control of the buttons assigned with configuration software.
 Setting the threshold control.
 With wall support.

CONTROL DIAGRAM - EXAMPLE



Sepic | Emergency 230~240V AC

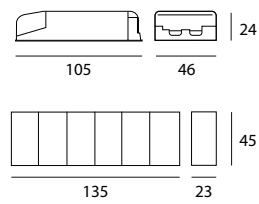

range	output	input	eff.	PF	surge	
1-5 W stripLED	150mA 24V	230~240V AC	80%	0.55	1 kV	99339
1-4 W powerLEDs	350mA 14V	230~240V AC	80%	0.55	1 kV	

Switchable (on/off) with normal power supply by means of a switch on the L' and N' (switched line) input.
Automatic reset after replacing battery and/or LED lamp.
Supplied with Ni-MH 6 cell battery pack, "AA" series, 1600 mAh.

Boost | Emergency 190~250V AC / 260~360V DC

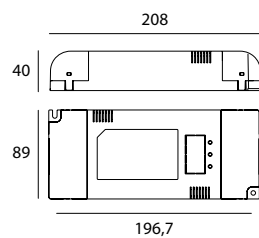

range	output	input	eff.	PF	surge	
13 W topLED	350mA 36V	190~250V AC	86%	0.9	4 kV	99085
12-15 W powerLEDs	350mA 45V	190~250V AC	86%	0.9	4 kV	
15 W arrayLED	400mA 37V	190~250V AC	86%	0.9	4 kV	99095
18-22.5 W powerLEDs	500mA 45V	190~250V AC	86%	0.9	4 kV	99089
20 W arrayLED	580mA 37V	190~250V AC	86%	0.9	4 kV	99096
23 W topLED	630mA 36V	190~250V AC	86%	0.9	4 kV	99086
24-30 W powerLEDs	630mA 45V	190~250V AC	86%	0.9	4 kV	
25 W arrayLED	720mA 37V	190~250V AC	86%	0.9	4 kV	99097
30 W topLED	840mA 36V	190~250V AC	86%	0.9	4 kV	99098
30 W arrayLED	840mA 37V	190~250V AC	86%	0.9	4 kV	
30 W topLED	840mA 40V	190~250V AC	86%	0.9	4 kV	
35 W arrayLED	950mA 37V	190~250V AC	86%	0.9	4 kV	99347
32 W topLED	950mA 36V	190~250V AC	86%	0.9	4 kV	
40 W arrayLED	1.1A 37V	190~250V AC	86%	0.9	4 kV	99242
50 W arrayLED	1.25A 37V	190~250V AC	86%	0.9	4 kV	99084
50 W topLED	1.25A 40V	190~250V AC	86%	0.9	4 kV	

Switchable (on/off) with normal power supply by means of a switch on the SL (switched line) input.
Automatic reset after replacing battery and/or LED lamp.
Electronic multi-level charging system.
Supplied with Ni-MH 6 cell battery pack, "AA" series, 1600 mAh.



98436
Cable and
connector



98440
Cable and
connector

Emergency light kit | Emergency 190~250V AC / 260~360V DC

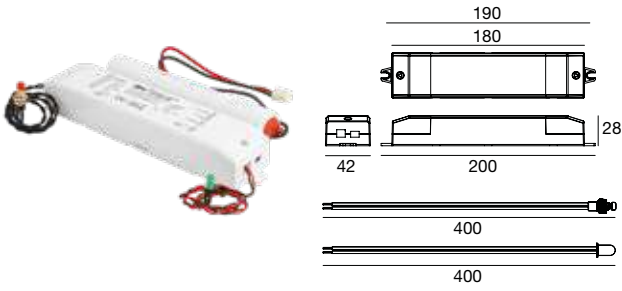

Switchable (on/off) in the presence of mains voltage via switch on SL input (switched line). Automatic reset following battery and/or LED lamp replacement. Electronic multilevel charging system. Supplied with 3000 mAh battery pack.

range	output	input	eff.	PF	surge	
Universal	6-60V 40-400mA	220~240V AC	86%	0.5	4 kV	99355
Frequency		50-60 Hz				
Nominal input current		40 mA (30 A inrush current with cold start)				
Outout voltage (without load)		6-60V				
TA Operating temperature		-25 +50 °C				
Max casing temperature TC		70 °C				
Control interface		Switch Line, Rest mode				
Protections		Overtemperature, overload, overvoltage, short-circuit, open circus				
Charge current		200 mA				
Emergency output current		400-40 mA				
Emergency power		2,4W				
Emergency output current		20 h				
Reference norms		EN 55015 (+A1+A2), EN 61000-3-3 (+A1), EN 61000-3-2 (+A2), EN 61547 (+A1), EN60598-2-22, EN61951-2, CEI EN 61347-1, CEI EN 61347-2-13, CEI EN 50366				

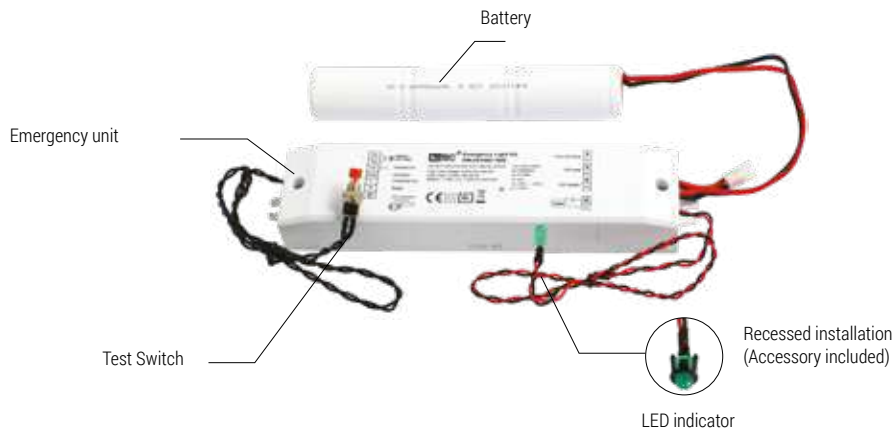

Unswitch Switch

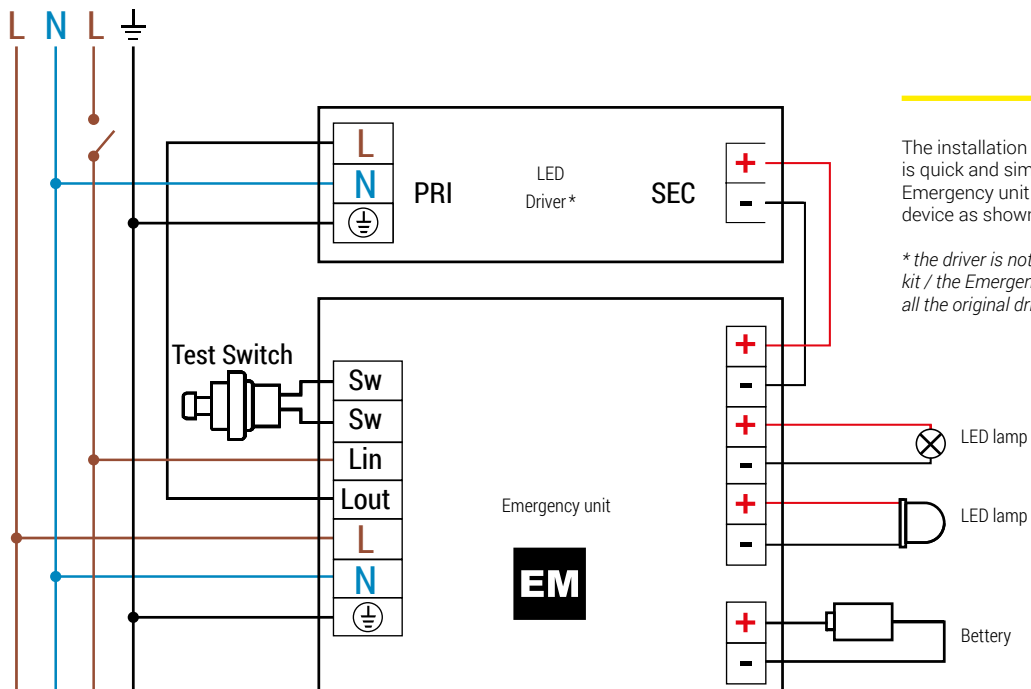

The installation of the emergency kit is quick and simple: just connect the Emergency unit to the driver of the LED device as shown in the diagram.

* the driver is not included in the Emergency kit / the Emergency kit can be connected to all the original drivers of the LED device

**FAST AND EASY
TO INSTALL**

EYE-WiFi

Once an EYE-WiFi device is connected to the electricity grid, it will be detected by the EYE-WiFi Gateway and displayed via the EYE-WiFi APP.

NETWORK EXTENSION: you can easily add an EYE-WiFi device to an existing network at any time

VERSATILITY: it is possible to modify the configuration of the devices and groups simply by intervening on the APP with a click.

HOTSPOT MODE (without router).

For lighting systems independent of the LAN network. WiFi connection of the smart device (smartphone, tablet or PC) to the EYE-WiFi Gateway.

Access data via WiFi: see back of the EYE-WiFi Gateway. Ability to connect a maximum of two smart devices simultaneously.



CLIENT MODE (with router)

To control more than 77 EYE-WiFi devices. WiFi connection from smart device (smartphone, tablet or PC) to the router.

Access data via WiFi: check router specs. WiFi connection of the router to the EYE-WiFi Gateway.

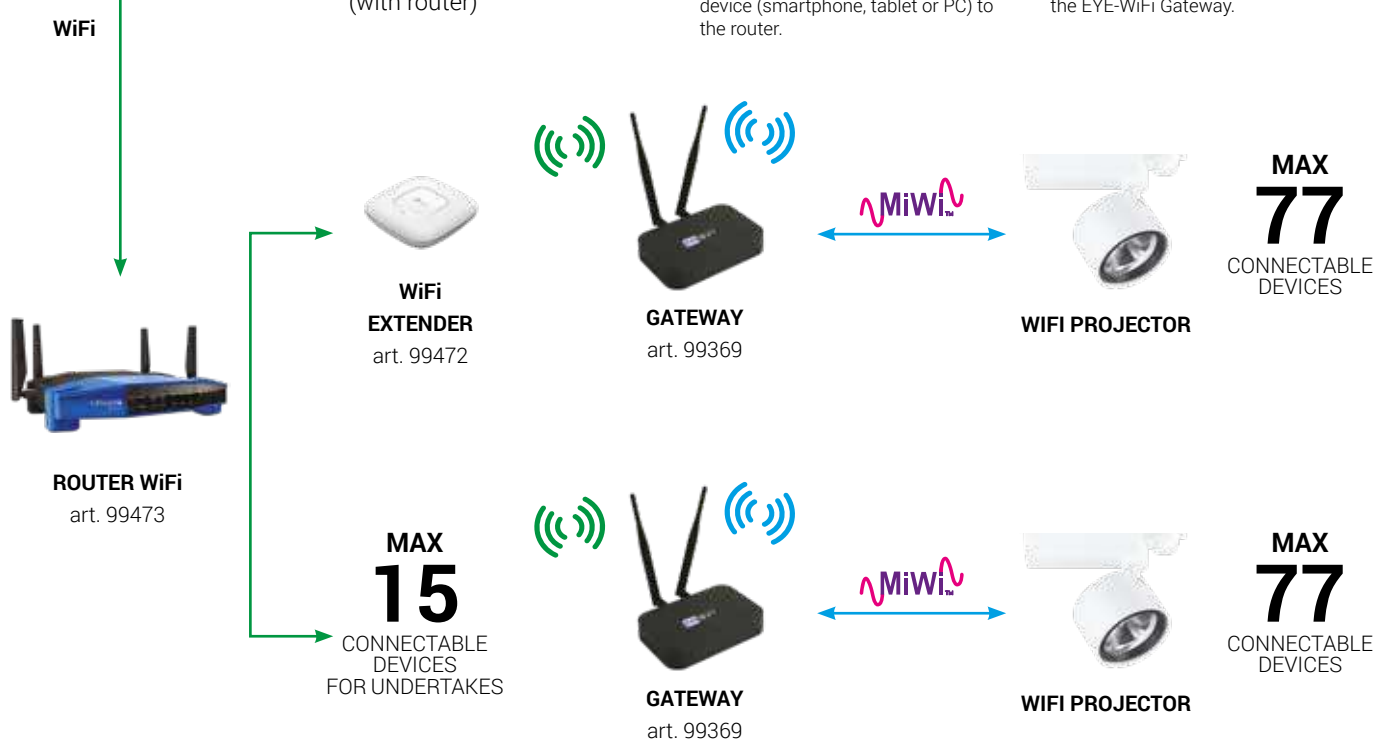

Gateway



The mobile devices are connected through the Gateway EYE-WiFi, which converts WiFi signals into MiWi signals. This way, the EYE-WiFi technology can be used in all IT networks. If it is not possible to use your existing IT network, you can use the Gateway Hotspot function to create a stand-alone, independent WiFi network.

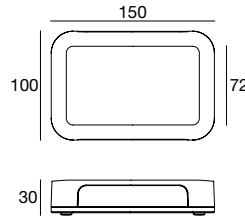

Black 99369

Network Standards

IEEE 802.11a/b/g/n

Radio Frequency Bands

2.4GHz

ATTENTION:

A Gateway EYE-WiFi can control up to 77 EYE-WiFi fixtures. As generic indications, we can provide the following maximum distances between Gateway EYE-WiFi and EYE-WiFi device:

- Alix_, maximum radius of 40m around the Gateway EYE-WiFi;
- Flamp_, Prolamp_, Alux_, maximum radius of 135m around the Gateway EYE-WiFi.

Linksys AC1900 WiFi Router

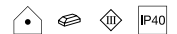

Simultaneous dual band (2.4 + 5 GHz) offers a stronger connection in a wider range than a single band with AC1900 speed. Equipped with 4 high-performance antennas, they provide optimum coverage and maximum signal strength even in large spaces or multi-storey buildings.

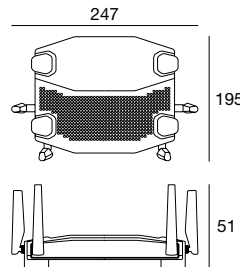

Black 99473

Network Standards

IEEE 802.11a/b/g/n/ac

Radio Frequency Bands

2.4 & 5GHz

Ports

USB 3.0, gigabit Ethernet

CPU

1.3 GHz dual-core processor

TP-Link Extender

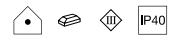

The latest generation Access Point (802.11ac standard) ensures superior wireless performance and high network coverage, both at 2.4GHz and 5GHz. TP-Link Extender allows to extend the WiFi range generated by Linksys AC1900 WiFi Router, it grant WiFi network coverage even in extended areas.

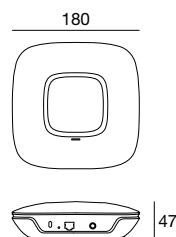

White 99472

Network Standards

IEEE 802.11a/b/g/n/ac

Radio Frequency Bands

2.4GHz & 5GHz

Supply

PoE (power over Ethernet) 802.af or driver

LINEA LIGHT GROUP

code	name	page
8010	Chlorophyll	124
8011	Chlorophyll	124
8012	Chlorophyll	124
8195	Tu-V	190
8196	Tu-V	190
8197	Tu-V	190
8198	Tu-O	190
8199	Tu-O	190
8200	Straight_P1	194
8201	Straight_P1	194
8202	Straight_P3	194
8203	Straight_P3	194
8204	Straight_P1	194
8205	Straight_P1	194
8206	Straight_P3	194
8207	Straight_P3	194
8227	Box_SQ	205
8228	Box_SQ	205
8229	Box_SQ	205
8230	Box_SQ	205
8231	Box_SQ	205
8232	Box_SQ	205
8233	Box_SQ	205
8234	Box_SQ	205
8236	Box_SR	204
8237	Box_SR	204
8238	Box_SR	204
8239	Box_SR	204
8240	Box_SR	204
8241	Box_SR	204
8242	Box_SR	204
8243	Box_SR	204
8562	Thin	126
8563	Thin	126
8566	Thin	126
8567	Thin	126
8570	Thin	126
8571	Thin	126
8574	Reika	127
8575	Reika	127
8578	Reika	127
8579	Reika	127
8582	Reika	127
8583	Reika	127
8586	Vertical_P1x2	124
8587	Vertical_P1x2	124
8588	Vertical_P2	124
8589	Vertical_P2	124
10114	Oh!_P	198

code	name	page
10117	Oh!_PMX	199
10131	Oh!_PMS	199
10132	Oh!_PMS	199
10133	Oh!_PMS	199
10134	Oh!_PMS	199
10135	Oh!_P	198
10136	Oh!_P	198
10137	Oh!_P	198
10138	Oh!_P	198
64306	Carter	99
64307	Carter	99
64316	Carter	99
64317	Carter	99
64326	Carter	99
64327	Carter	99
64336	Carter	99
64337	Carter	99
64346	Carter	101
64347	Carter	101
64356	Carter	101
64357	Carter	101
64366	Carter	101
64367	Carter	101
64376	End Carter	101
64377	End Carter	101
64386	L-Shaped Carter	101
64387	L-Shaped Carter	101
64390	Fixing Joint	99
64391	Power Supply Cable	99
64392	Extension Cable	99
64393	Extension Cable	99
64394	Extension Cable	99
64407	Carter	100
64408	Carter	100
64417	Carter	100
64418	Carter	100
64427	Carter	100
64428	Carter	100
64437	End Carter	100
64438	End Carter	100
64447	L-Shaped Carter	100
64448	L-Shaped Carter	100
64457	C Junction	99
64458	C Junction	99
64467	C Junction	100
64468	C Junction	100
64570	Tour PD	180
64571	Tour PD	180
64572	Tour PD	180

code	name	page
64573	Tour PD	180
64575	Suspension Kit	183
64576	DALI Interface	105
64577	Tour PI	182
64578	Ceiling Rose	183
64579	Tour PI	182
64580	Ceiling Rose	187
64581	Tour PI	182
64583	Tour PU	181
64584	Tour PU	181
64585	Tour PU	181
64586	Ceiling Rose	183
64587	Tour PU	181
64588	Ceiling Rose	183
64670	Suspension Kit	183
64671	Suspension Kit	183
64672	Suspension Kit	183
64673	Suspension Kit	183
64682	Tour PU	181
64683	Tour PU	181
64684	Tour PU	181
64685	Tour PU	181
64686	Tour PU	181
64687	Tour PU	181
64688	Tour PU	181
64689	Tour PU	181
64690	Tour PU	181
64691	Tour PU	181
64692	Tour PU	181
64693	Tour PU	181
64694	Tour PU	181
64695	Tour PU	181
64696	Tour PU	181
64697	Tour PU	185
64741	Baton P1	186
64742	Baton P1	186
64743	Baton P2	186
64744	Baton P2	186
64754	Baton P1	186
64755	Baton P2	186
64782	Baton P4	186
64783	Baton P4	186
64784	Baton P4	186
64785	Baton P3	186
64786	Baton P3	186
64787	Baton P3	186
65100	Tour PI	182
65101	Tour PI	182
65102	Tour PI	182



code	name	page
65103	Tour PI	182
65104	Tour PI	182
65105	Tour PI	182
65106	Tour PI	182
65107	Tour PI	182
65108	Tour PI	182
65109	Tour PI	182
65110	Tour PI	182
65111	Tour PI	182
65112	Tour PD	180
65113	Tour PD	180
65114	Tour PD	180
65115	Tour PD	180
65116	Tour PD	180
65117	Tour PD	180
65118	Tour PD	180
65119	Tour PD	180
65120	Tour PD	180
65121	Tour PD	180
65122	Tour PD	180
65123	Tour PD	180
65124	Tour PD	180
65125	Tour PD	180
65126	Tour PD	180
65127	Tour PD	180
65128	Tour PD	180
65129	Tour PD	180
65130	Tour PD	180
65131	Tour PD	180
65132	Tour PI	182
65133	Tour PI	182
65134	Tour PI	182
65135	Tour PU	181
65136	Tour PU	181
65137	Tour PU	181
65138	Tour PU	181
65141	Suspension Kit	183
65142	Ceiling Rose	183
65143	Ceiling Rose	183
65144	Ceiling Rose	183
65145	Ceiling Rose	183
65146	Ceiling Rose	183
65147	Ceiling Rose	183
65148	Ceiling Rose	183
65149	Ceiling Rose	183
65150	Ceiling Rose	183
65151	Ceiling Rose	183
65152	Ceiling Rose	183
65153	Ceiling Rose	183

code	name	page
65154	Ceiling Rose	183
65155	Ceiling Rose	183
65156	Ceiling Rose	183
65157	Ceiling Rose	183
65158	Ceiling Rose	183
65159	Ceiling Rose	183
65160	Ceiling Rose	183
65161	Ceiling Rose	183
80013	Blob40_2	148
80014	Blob40_2	148
80015	Blob40_2	148
80016	Blob40_2	148
80077	Angular_4	53
80078	Angular_4	53
80079	Angular_4	53
80083	Pound_4	43
80084	Pound_4	43
80093	Creek Iris_1	93
80094	Creek Iris_1	93
80097	Creek Iris_2	93
80098	Creek Iris_2	93
80101	Creek Iris_3	96
80102	Creek Iris_3	96
80105	Blob40_1	148
80106	Blob40_1	148
80107	Blob40_1	148
80108	Blob40_1	148
80109	Cob40_RJ1	151
80110	Cob40_RJ1	151
80111	Pound_4 DALI	42
80112	Pound_4 DALI	42
80113	Pound_4 DALI	42
80114	Pound_4 DALI	42
80115	Pound_4 DALI	42
80116	Pound_4 DALI	42
80121	Angular_4	52
80122	Angular_4	52
80123	Angular_4	52
80127	Angular_5	57
80129	Angular40_5	57
80146	Pound_2	40
80147	Pound_2	40
80148	Pound_2	40
80149	Pound_2	40
80150	Pound_3	41
80151	Pound_3	41
80152	Pound_3	41
80153	Pound_3	41
80154	Pound_4	42

code	name	page
80155	Pound_4	42
80156	Pound_4	42
80157	Pound_4	42
80158	Pound_4	43
80159	Pound_4	43
80160	Pound_4	43
80161	Pound_4	43
80162	Iris-T_0	70
80163	Iris-T_0	70
80166	Optus-T_2	64
80167	Optus-T_2	64
80170	Optus-T_2 Eye Wifi	65
80171	Optus-T_2 Eye Wifi	65
80174	Creek Pound_1	92
80175	Creek Pound_1	92
80178	Creek Optus_1	92
80179	Creek Optus_1	92
80182	Creek Optus_2	96
80183	Creek Optus_2	96
80186	Angular_4 DALI	52
80187	Angular_4 DALI	52
80188	Angular_4 DALI	52
80192	Angular40_3	51
80193	Angular40_3	51
80194	Angular40_3	51
80198	Angular40_4	53
80199	Angular40_4	53
80200	Angular40_4	53
80212	Optus-T_1	64
80213	Optus-T_1	64
80216	Optus-T_1 Eye Wifi	65
80217	Optus-T_1 Eye Wifi	65
80220	Optus_EX1	134
80221	Optus_EX1	134
80232	Optus_EX2	108
80233	Optus_EX2	108
80238	Optus_EX2	135
80239	Optus_EX2	135
80241	Optus_EX2	135
80242	Optus_EX2	135
80244	Cob40_R1	151
80245	Cob40_R1	151
80248	Angular_5 DALI	56
80249	Angular_5 DALI	56
80250	Angular_5 DALI	56
80254	Optus-T_1	64
80255	Optus-T_1	64
80256	Optus-T_1	64
80257	Optus-T_1	64

code	name	page	code	name	page	code	name	page
80258	Optus-T_2	64	80420	Creek Optus_2	96	81020	Clip tend. sosp.	77
80259	Optus-T_2	64	80421	Creek Optus_2	96	81021	Sosp. rigida 1m	77
80260	Optus-T_2	64	80424	Iris-T_0	70	81022	Sosp. rigida 1m	77
80261	Optus-T_2	64	80425	Iris-T_0	70	81023	Sosp. rigida 1m	77
80262	Optus-T_1 Eye Wifi	65	80426	Iris-T_1	70	81024	Staffa di irrigid.	77
80263	Optus-T_1 Eye Wifi	65	80427	Iris-T_1	70	81025	Staffa di irrigid.	77
80264	Optus-T_1 Eye Wifi	65	80428	Iris-T_2	71	81026	Staffa di irrigid.	77
80265	Optus-T_1 Eye Wifi	65	80429	Iris-T_2	71	81027	Base alim. plaf.	77
80266	Optus-T_2 Eye Wifi	65	80430	Iris-T_3	71	81028	Base alim. plaf.	77
80267	Optus-T_2 Eye Wifi	65	80431	Iris-T_3	71	81029	Base alim. plaf.	77
80268	Optus-T_2 Eye Wifi	65	80981	Binario trifase+DALI 1m	76	81030	Adatt. inc. per base	77
80269	Optus-T_2 Eye Wifi	65	80982	Binario trifase+DALI 2m	76	81031	Adatt. inc. per base	77
80270	Creek Optus_1	92	80983	Binario trifase+DALI 3m	76	81032	Adatt. inc. per base	77
80271	Creek Optus_1	92	80984	Binario trifase+DALI 1m	76	81033	Alim. testa	76
80272	Iris-T_1	70	80985	Binario trifase+DALI 2m	76	81034	Alim. testa	76
80273	Iris-T_1	70	80986	Binario trifase+DALI 3m	76	81035	Alim. testa	76
80278	Angular_P4	59	80987	Binario trifase+DALI 1m	76	81036	Alim. testa	76
80279	Angular_P4	59	80988	Binario trifase+DALI 2m	76	81037	Alim. testa	76
80280	Angular_P4	59	80989	Binario trifase+DALI 3m	76	81038	Alim. testa	76
80284	Angular_P5	59	80990	Binario trifase inc+DALI 1m	76	81039	Giunto el. interno	76
80285	Angular_P5	59	80991	Binario trifase inc+DALI 2m	76	81040	Giunto el. interno	76
80286	Angular_P5	59	80992	Binario trifase inc+DALI 3m	76	81041	Giunto el. interno	76
80290	Optus-W2	81	80993	Binario trifase inc+DALI 1m	76	81042	Giunto centrale	76
80291	Optus-W2	81	80994	Binario trifase inc+DALI 2m	76	81043	Giunto centrale	76
80294	Optus-W2	81	80995	Binario trifase inc+DALI 3m	76	81044	Giunto centrale	76
80295	Optus-W2	81	80996	Binario trifase inc+DALI 1m	76	81045	Giunto a L	76
80296	Optus-W2	81	80997	Binario trifase inc+DALI 2m	76	81046	Giunto a L	76
80297	Optus-W2	81	80998	Binario trifase inc+DALI 3m	76	81047	Giunto a L	76
80298	Optus-W3	81	80999	Tappo di chiusura	76	81048	Giunto a L	76
80299	Optus-W3	81	81000	Tappo di chiusura	76	81049	Giunto a L	76
80302	Optus-W3	81	81001	Tappo di chiusura	76	81050	Giunto a L	76
80303	Optus-W3	81	81002	Tappo di chiusura inc.	76	81051	Giunto a T	76
80304	Optus-W3	81	81003	Tappo di chiusura inc.	76	81052	Giunto a T	76
80305	Optus-W3	81	81004	Tappo di chiusura inc.	76	81053	Giunto a T	76
80306	Iris-T_2	71	81005	Pinza per taglio conduttori	77	81054	Giunto a T	76
80307	Iris-T_2	71	81006	Sosp. con regolatore 1,5m	77	81055	Giunto a T	76
80310	Iris-T_3	71	81007	Sosp. con regolatore 5m	77	81056	Giunto a T	76
80311	Iris-T_3	71	81008	Sosp. con regolatore 1,5m	77	81057	Giunto a T	76
80334	Pound_4	42	81009	Sosp. con regolatore 5m	77	81058	Giunto a T	76
80335	Pound_4	42	81010	Sosp. con regolatore 1,5m	77	81059	Giunto a T	76
80338	Mini-Illuminator	141	81011	Sosp. con regolatore 5m	77	81060	Giunto a T	76
80342	Optus_EX1	134	81012	Sosp. 1,5m	77	81061	Giunto a T	76
80343	Optus_EX1	134	81013	Sosp. 5m	77	81062	Giunto a T	76
80344	Optus_EX1	134	81014	Sosp. 1,5m	77	81063	Giunto a X	76
80345	Optus_EX1	134	81015	Sosp. 5m	77	81064	Giunto a X	76
80387	Illuminator_1 25W	143	81016	Sosp. 1,5m	77	81065	Giunto a X	76
80388	Illuminator_1 25W	143	81017	Sosp. 5m	77	81066	Giunto flessibile	76
80389	Illuminator_1 15W	143	81018	Clip tend. sosp.	77	81067	Giunto flessibile	76
80390	Illuminator_1 15W	143	81019	Clip tend. sosp.	77	81068	Giunto flessibile	76

































code	name	page	code	name	page	code	name	page
81069	Copertura testa alim.	77	90517	Tee_2	85	90929	Trail	119
81070	Copertura testa alim.	77	90518	Tee_2	85	90930	Trail	119
81071	Copertura testa alim.	77	90585	Angular_2	50	90931	Trail	119
81072	Copertura giunto centrale	77	90586	Angular_2	50	90932	Trail	119
81073	Copertura giunto centrale	77	90587	Angular_2	50	90933	Trail	119
81074	Copertura giunto centrale	77	90591	Pound_2	40	90934	Trail	119
81075	Copertura giunto a L	77	90592	Pound_2	40	90935	Trail	119
81076	Copertura giunto a L	77	90597	Pound_3	41	90936	Trail	119
81077	Copertura giunto a L	77	90599	Pound_3	41	90943	Trail suspension kit	120
81078	Copertura giunto a T	77	90603	Angular_2	51	90944	Trail suspension kit	120
81079	Copertura giunto a T	77	90604	Angular_2	51	90945	Trail bracket	120
81080	Copertura giunto a T	77	90605	Angular_2	51	90946	Trail Cap	120
81081	Copertura giunto a X	77	90614	Angular_1	50	90947	Trail Cap	120
81082	Copertura giunto a X	77	90615	Angular_1	50	90950	Trail Cover	120
81083	Copertura giunto a X	77	90616	Angular_1	50	90951	Trail Cover	120
81084	Guarnizione per testa alim.	77	90617	Pound_1	40	90952	Trail track system	120
81085	Guarnizione per testa alim.	77	90618	Pound_1	40	90953	Trail track system	120
81091	Adatt. bin. trif.+DALI	77	90746	LV44_RD5	171	91229	Illuminator_3	143
81092	Adatt. bin. trif.+DALI	77	90747	LV44_RD5	171	91230	Illuminator_3	143
81093	Adatt. bin. trif.+DALI	77	90894	Angular_5	56	91769	LV44_RD1	170
81094	Adatt. bin. trif.	77	90895	Angular_5	56	91776	LV44_RD1	170
81095	Adatt. bin. trif.	77	90903	Trail chassis	118	91777	LV44_RD2	170
81096	Adatt. bin. trif.	77	90904	Trail chassis	118	91778	LV44_RD2	170
89144	Driver	210	90905	Trail chassis	118	91779	LV44_RD3	170
89147	Driver	210	90905E	Trail chassis	118	91780	LV44_RD3	170
89148	Driver	210	90906	Trail chassis	118	91781	LV44_RD4	171
89151	Driver	210	90906E	Trail chassis	118	91783	LV44_RD4	171
90495	Tee_1	84	90907	Trail chassis	118	93354	Cob44_Q	155
90496	Tee_1	84	90908	Trail chassis	118	93355	Cob44_Q	155
90497	Tee_1	84	90909	Trail chassis	118	93832	Cob44_R	154
90498	Tee_1	84	90910	Trail chassis	118	93833	Cob44_R	154
90499	Tee_1	84	90911	Trail chassis	118	93834	Cob44_RJ	154
90500	Tee_1	84	90912	Trail chassis	118	93835	Cob44_RJ	154
90501	Tee_1	84	90913	Trail chassis	118	93836	Cob44_Q	155
90502	Tee_1	84	90914	Trail chassis	118	93839	Cob44_Q	155
90503	Tee_1	84	90915	Trail chassis	118	93840	Cob44_QJ	155
90504	Tee_1	84	90916	Trail chassis	118	93843	Cob44_QJ	155
90505	Tee_1	84	90917	Trail chassis	118	93844	Cob44_QJ	155
90506	Tee_1	84	90918	Trail chassis	118	93847	Cob44_QJ	155
90507	Tee_2	85	90919	Trail	119	93858	Angular40_5	57
90508	Tee_2	85	90920	Trail	119	93859	Angular40_5	57
90509	Tee_2	85	90921	Trail	119	96801	Cob44_R	154
90510	Tee_2	85	90922	Trail	119	96802	Cob44_R	154
90511	Tee_2	85	90923	Trail	119	96803	Cob44_RJ	154
90512	Tee_2	85	90924	Trail	119	96804	Cob44_RJ	154
90513	Tee_2	85	90925	Trail	119	96809	Cob20_R	160
90514	Tee_2	85	90926	Trail	119	96813	Cob20_R	160
90515	Tee_2	85	90927	Trail	119	96819	Cob20_R	161
90516	Tee_2	85	90928	Trail	119	96827	Cob20_Q	162

code	name	page	code	name	page	code	name	page
96831	Cob20_Q	162	98800	Live-end Left	76	98862	Live-end	77
96837	Cob20_Q	163	98801	Live-end Left	76	98863	Live-end	77
97130	Cob20_R	161	98802	Central Connector	76	98864	Live-end	77
98436	Accessori / Cavi	220	98803	Central Connector	76	98865	Live-end	77
98440	Cable	220	98804	Central Connector	76	98866	Live-end	77
98503	Cylindrical Screen	56 - 59	98805	Electrical Straight Joint	76	98867	Central Connector	77
98504	45° Cylindrical Screen	56 - 59	98806	Electrical Straight Joint	76	98868	Central Connector	77
98505	Directional Flap	56	98807	Flexible Joint	76	98869	Central Connector	77
98506	Cross	56	98808	Flexible Joint	76	98872	Central Connector 2m	76
98507	Spot Reflector	143	98809	Flexible Joint	76	98873	Central Connector 2m	76
98508	Medium Flood Reflector	143	98810	L Joint IN	76	98874	Central Connector 5m	76
98509	Flood Reflector	143	98811	L Joint IN	76	98875	Central Connector 5m	76
98511	Honeycomb	56 - 59	98812	L Joint IN	76	98972	Tee Accessory	86
98515	Transparent Filter	42 - 43 - 52 - 53 - 59 - 64 - 65 - 108	98813	L Joint OUT	76	98973	Tee Accessory	86
98516	Opaline Filter	42 - 43 - 52 - 53 - 59 - 64 - 65 - 108	98814	L Joint OUT	76	98974	Tee Accessory	86
98517	Elliptical Filter	56 - 59	98815	L Joint OUT	76	98975	Tee Accessory	86
98518	45° Cylindrical Screen	42 - 43 - 52 - 53 - 59 - 64 - 65 - 108 - 135	98816	T Joint Left	76	98976	Tee Accessory	87
98519	Cylindrical Screen	42 - 43 - 52 - 53 - 59 - 64 - 65 - 108 - 135	98817	T Joint Left	76	98977	Tee Accessory	87
98520	Cross	42 - 43 - 52 - 53 - 59 - 64 - 65 - 108 - 135	98818	T Joint Left	76	98978	Tee Accessory	87
98521	Elliptical Filter	42 - 43 - 52 - 53 - 59	98819	T Joint Right	76	98979	Tee Accessory	87
98522	Honeycomb	42 - 43 - 52 - 53 - 59	98820	T Joint Right	76	98980	Tee Accessory	86
98523	Directional Flap	42 - 43 - 52 - 53 - 59 - 64 - 65 - 108 - 135	98821	T Joint Right	76	98981	Tee Accessory	86
98524	Spot Reflector	42 - 43 - 52 - 53 - 59 - 64 - 65 - 108	98822	X Joint	76	98982	Tee Accessory	86
98525	Medium Flood Reflector	42 - 43 - 52 - 53 - 59 - 64 - 65 - 108	98823	X Joint	76	98983	Tee Accessory	86
98526	Flood Reflector	42 - 43 - 52 - 53 - 59 - 64 - 65 - 108	98824	X Joint	76	98995	Spot Lens	40 - 50 - 64 - 65 - 81 - 94 - 134
98787	Track System 1m	76	98825	Dead-end	76	98996	Medium Flood Lens	40 - 50 - 64 - 65 - 81 - 94 - 134
98788	Track System 1m	76	98826	Dead-end	76	98997	Flood Lens	40 - 50 - 64 - 65 - 81 - 94 - 134
98789	Track System 1m	76	98827	Dead-end	76	99074	Bode	216
98790	Track System 2m	76	98828	Stiffening Bracket	76	99077	Nyquist	216
98791	Track System 2m	76	98829	Fixing Bracket	76	99084	Boost	220
98792	Track System 2m	76	98830	Track Cover	76	99085	Boost	220
98793	Track System 3m	76	98831	Track Cover	76	99086	Boost	220
98794	Track System 3m	76	98832	Central Connector 2m	76	99089	Boost	220
98795	Track System 3m	76	98833	Central Connector 2m	76	99093	Leon_Easy-Plug	211
98796	Live-end Right	76	98834	Central Connector 5m	76	99095	Boost	220
98797	Live-end Right	76	98835	Central Connector 5m	76	99096	Boost	220
98798	Live-end Right	76	98846	Track System 1m	77	99097	Boost	220
98799	Live-end Left	76	98847	Track System 1m	77	99098	Boost	220
			98848	Track System 1m	77	99106	Leon	211
			98849	Track System 2m	77	99112	Leon_Easy-Plug	211
			98850	Track System 2m	77	99113	Leon_Easy-Plug	211
			98851	Track System 2m	77	99114	Photon	213
			98852	Track System 3m	77	99115	Boson	212
			98853	Track System 3m	77	99116	Boson_Easy-Plug	212
			98854	Track System 3m	77	99131	Photon_Easy-Plug	213
			98858	Dea-end	77	99147	Leon	211
			98859	Dea-end	77			
			98860	Dea-end	77			
			98861	Live-end	77			

code	name	page
99155	Theo	215
99187	Serban_Easy-Plug	213
99188	Serban_Easy-Plug	213
99239	Leon	211
99241	Serban_Easy-Plug	215
99242	Boost	220
99243	BIT	210
99252	Clerk_Easy-Plug	211
99254	Serban_Easy-Plug	215
99262	Boson_Easy-Plug	212
99268	Serban	214
99308	Dali_USB	218
99309	Dali_PS1	218
99310	Dali_PS2	218
99311	Dali_XC	218
99312	Dali_Msensor	219
99313	Dali_Msensor	219
99330	Argo_Easy-Plug	214
99331	Reson_150	216
99332	Reson_150_1-10V	217
99334	Dali_RC	219
99339	Sepic	220
99341	Defender	208
99344	Argo	214
99345	Argo	214
99347	Boost	220
99355	Emergency kit	221
99369	Gateway	223
99370	Bit	210
99373	Planck	213
99374	Reson_75	216
99399	Cross	40 - 50 - 94
99400	Honeycomb	40 - 50 - 94
99401	Elliptical Filter	40 - 50 - 94
99402	Cylindrical Screen	40 - 50 - 94
99403	45° Cylindrical Screen	40 - 50 - 94
99404	Medium Flood Reflector	64 - 65 - 108 - 135
99405	Flood Reflector	64 - 65 - 108 - 135
99406	Wide Flood Reflector	64 - 65 - 108 - 135
99408	Spot Reflector	56 - 57 - 59 - 65
99409	Medium Flood Reflector	56 - 57 - 59 - 65
99410	Flood Reflector	56 - 57 - 59 - 65
99411	Transparent Filter	56 - 59
99448	Spot Lens	40 - 50 - 94
99449	Medium Flood Lens	40 - 50 - 94
99450	Flood Lens	40 - 50 - 94

code	name	page
99471	Spot Reflector	64 - 65 - 108 - 135
99472	TP-Link Estender	223
99473	Router	223
99479	Kicker	108 - 135
99485	Mini-Illuminator Outer-c.	140
99486	Mini-Illuminator Outer-c. 2x	140
99487	Mini-Illuminator Outer-c. 3x	140
99488	Mini-Illuminator Outer-c.	140
99489	Mini-Illuminator Outer-c. 2x	140
99490	Mini-Illuminator Outer-c. 3x	140
99497	Illuminator Outer-c.	142
99498	Illuminator Outer-c. 2x	142
99499	Illuminator Outer-c. 3x	142
99500	Illuminator Outer-c.	142
99501	Illuminator Outer-c. 2x	142
99502	Illuminator Outer-c. 3x	142
99503	Tee Accessory	87
99504	Tee Accessory	87
99505	Tee Accessory	87
99506	Tee Accessory	87
99508	Cylindrical Screen	40 - 50
99509	Honeycomb	40 - 50
99510	Kicker	40 - 50
99511	Cross	40 - 50
99512	45° Cylindrical Screen	40 - 50
99513	Elliptical Filter	41 - 51
99514	Cylindrical Screen	41 - 51
99515	Honeycomb	41 - 51 - 52
99516	Opal Filter	41 - 51 - 52
99517	Cross	41 - 51
99518	45° Cylindrical Screen	41 - 51 - 52
99522	DUALdrive 560/A	215
99523	DUALdrive 560/A	215
99524	DUALdrive 560/A	215
99525	DUALdrive 560/A	215
99527	Opal Filter	56 - 57 - 59
99530	Elliptical Filter	40 - 50 - 64 - 65 - 81 - 94 - 134
99531	Honeycomb	64 - 65 - 81 - 94 - 134
99532	Cross	64 - 65 - 81 - 94 - 134
99533	Cylindrical Screen	64 - 65 - 81 - 94 - 134
99534	45° Cylindrical Screen	64 - 65 - 81 - 94 - 134
99550	Honeycomb	140
99551	Honeycomb	142

code	name	page
99552	Elliptical Filter	140
99553	Elliptical Filter	142
99554	Cylindrical Screen	140
99555	Cylindrical Screen	142
99561	Medium Flood Reflector	143
99562	Flood Reflector	143
99565	Spot Reflector	41 - 51
99566	Medium Flood Reflector	41 - 51
99567	Flood Reflector	41 - 51
99568	Opal Filter	41 - 51
99569	Transparent Filter	41 - 51
99572	Mini Jolly	212
99573	Driver	212
99640	Track System base	77
99641	Track System base	77
99642	Track System base	77
98521	Elliptical Filter	64 - 65 - 98 - 108 - 135
98522	Honeycomb	64 - 65 - 98 - 108 - 135
10114.01	Oh!_P	198
10114.02	Oh!_P	198
10135.01	Oh!_P	198
10135.02	Oh!_P	198
10136.01	Oh!_P	198
10136.02	Oh!_P	198
10137.01	Oh!_P	198
10137.02	Oh!_P	198
10138.01	Oh!_P	198
10138.02	Oh!_P	198
KIT0067	Driver	126 - 127
KIT0068	Driver	126 - 127
KIT0069	Driver	126 - 127
KIT0070	Driver	126 - 127
KIT0071	Driver	126 - 127
KIT0072	Driver	126 - 127

	Indoor Installation		Article protected by resin
	Outdoor Installation		Round installation hole
	Wall mounting		Fixture suitable for mounting on furniture
	Ground mounting		Fixture suitable for mounting on flammable surfaces (EN 60598)
	Ceiling mounting		Fixture with built-in thermal protection
	Wall or ground mounting		Simply DIM
	Ceiling or wall mounting		1-10 V
	Ceiling, wall or ground mounting		DMX 512
	Ceiling or ground mounting		DALI
	Stainless steel	C.C.	Constant Current
	Protection index (IEC 60529) from foreign bodies and water	C.V.	Constant Voltage
	Protection index (IEC 62262) against external mechanical impacts		Infrared
	Adjustable light beam		
	Tilting light beam		
	Walk-over lighting fixture		
	Drive unit (2,500 kg)		
	Power cable included		
	Class I - electrical insulation class (IEC)		All items are energy class A ++.
	Class II - electrical insulation class (IEC)		The values shown, unless otherwise stated, refer to the emission of the source and are susceptible to tolerances as shown in the following table:
	Class III - electrical insulation class (IEC)		Emission $\pm 7\%$ lm CRI ± 2 points on the typical value CCT ± 80 K Driver absorption $\pm 9\%$ W
	Driver included		
	Driver not included		The connection diagrams for the electronics items are available in the technical documentation.
	Over Voltage Protection		

Product image

Code composition table = product code + colour + optics

Listed technical design

185

Box_SR | Ceiling Lights | 190-250 V | 7 W 500 mA topLED



Color	8236	3000 K	752 lm	General
Optics	8237			
Color	8236M	4000 K	811 lm	General
Optics	8237M			

Box_SR | Ceiling Lights | 190-250 V | 17 W 900 mA topLED



Color	8238	3000 K	1880 lm	General
Optics	8239			
Color	8238M	4000 K	2027 lm	General
Optics	8239M			

Box_SR | Ceiling Lights | 190-250 V | 25 W 1000 mA topLED



Color	8240	3000 K	2878 lm	General
Optics	8241			
Color	8240M	4000 K	3108 lm	General
Optics	8241M			

Box_SR | Ceiling Lights | 190-250 V | 48 W 1000 mA topLED



Color	8242	3000 K	5211 lm	General
Optics	8243			
Color	8242M	4000 K	5650 lm	General
Optics	8243M			

Box_SQ | Ceiling Lights | 220-240 V | topLED 7 W 500 mA



Color	8227	3000 K	752 lm	Diffused
Optics	8228			
Color	8227M	4000 K	811 lm	Diffused
Optics	8228M			

Box_SQ | Ceiling Lights | 220-240 V | topLED 17 W 700 mA



Color	8229	3000 K	1880 lm	Diffused
Optics	8230			
Color	8229M	4000 K	2027 lm	Diffused
Optics	8230M			

Box_SQ | Ceiling Lights | 220-240 V | topLED 25 W 700 mA



Color	8231	3000 K	3060 lm	Diffused
Optics	8232			
Color	8231M	4000 K	3383 lm	Diffused
Optics	8232M			

Box_SQ | Ceiling Lights | 220-240 V | topLED 43 W 500 mA



Color	8233	3000 K	4888 lm	Diffused
Optics	8234			
Color	8233M	4000 K	5270 lm	Diffused
Optics	8234M			

RETAIL 2018

Ceiling & Suspended

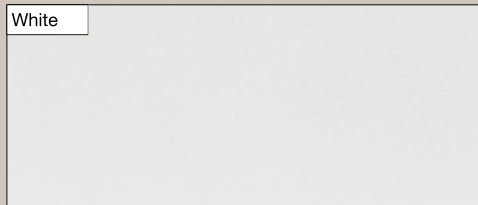

White | RAL 9003 embossed

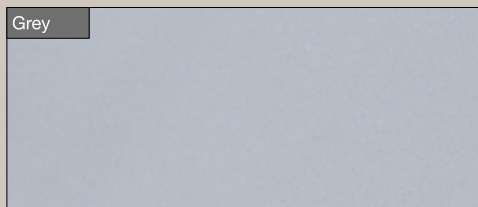

Gray | RAL 9006 embossed

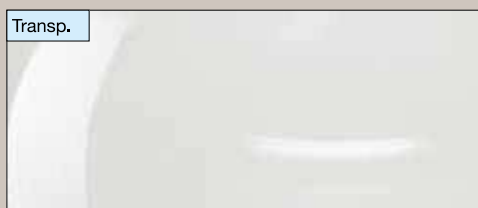

Transparent | PMMA



Concrete



Bronze

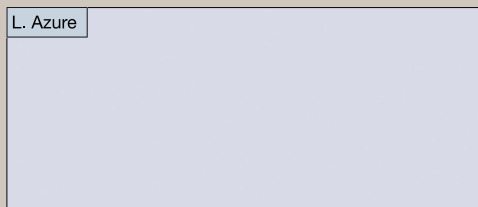

Light Azure_ polished

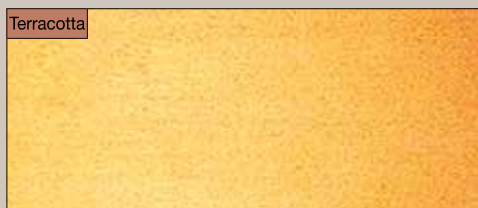

Earthenware

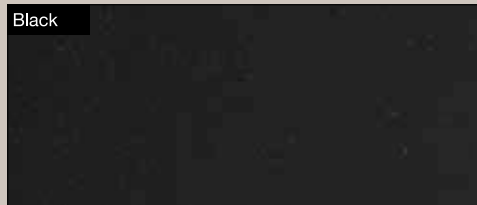

Black | RAL 9005 embossed

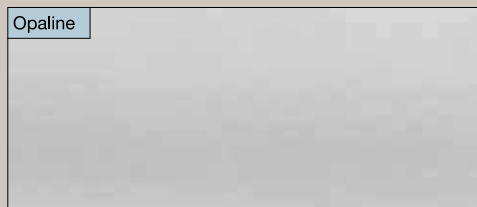

Opaline | PMMA

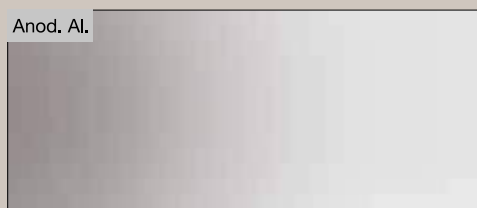

Anodised aluminium

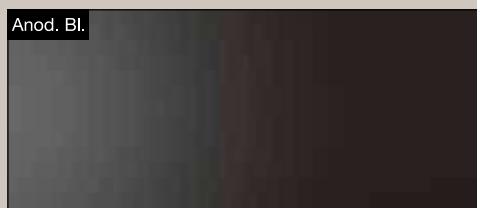

Anodised aluminium black



Rose gold



Pink_ polished

Linea Light S.r.l. Italy

via della Fornace, 59 z.i.
31023 Castelminio di Resana (TV) - Italy
Phone: +39 0423 78 68
Fax: +39 0423 78 69 00
info@linealight.com

LightVillage Milano

Exhibition Area Only
via Morimondo, 26 int. 17G
20143 Milano - Italy
Phone: +39 02 36750915
Fax: +39 02 36750915
milano@lightvillage.it

Linea Light Roma

Via Stendhal, 22
00144 Roma - Italy
Phone: +39 06 5935106
info@linealightroma.com

Linea Light France

Z.A. Heiden Est, 12 rue des Pays-Bas
68310 Wittelsheim - France
Phone: +33 389 75 52 23
Fax: +33 389 75 59 07
info@linealight.fr

Linea Light Deutschland GmbH

Aktienstraße 214
45473 Mülheim a.d. Ruhr - Germany
Phone: +49 208 299979-0
Fax: +49 208 299979-10
service@linealight.de

Linea Light Polska Sp. z o.o.

ul. Wiosenna, 47
41253 Czeladz - Poland
Phone: +48 32 760 98 71
Fax: +48 32 760 98 76
biuro@linealight.com.pl

Linea Light USA - Inter Lux

3741 Commerce Drive
Suites 306-308
Baltimore, MD 21227 - USA
Phone: +1 410 381 1497
Fax: +1 410 381 1589
answers@inter-lux.com

Linea Light UK Ltd

Suite 109 - Business Design Centre
52 Upper Street - Islington N10QH
London - UK
Phone: +44 0203 6371983
info@linealight-uk.com

Linea Light Russia

Luzhnetskaya nab., 2/4, str. 3, of. 304
119270 Moscow - Russian Federation
Phone: +7 495 639 99 41
info@linealight.ru

Linea Light GCC

Middle East & Gulf Countries
Jumeirah Lake Towers
JBC2 - 35th Floor Office 02 - Dubai - UAE
P.O. Box 125902
Phone: +971 4 4218275
Fax: +971 4 4218274
info@linealight.ae

Linea Light Asia - Pacific Ltd

YuXiang Industrial Area
528478 HengLan Town, ZhongShan City,
GuangDong Province, China
Phone: +86 760 87618355
Fax: +86 760 87553990
info@linealight.cn

Linea Light Singapore

Operative office
21 Kaki Bukit Place, 5th Floor
416199 Singapore
Registered office
180 Cecil Street, #10-02
Bangkok Bank Building
069546 - Singapore
Phone: +65 6908 5758
info@tfoasia.com

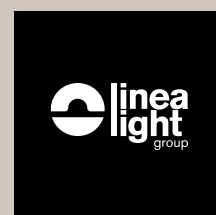

linealight.com

Art direction:

Linea Light Group - Marketing Dept.

Concept:

Andrea Babato

Press:

Imoco

Printed in Italy

2018

The drawings, quotas, materials and colours contained in this catalogue are merely indicative.

In the customers' interest, the Company reserves the right to modify models at any time without prior notice.



Your Light Future Proof